

PUM Series
Multi-loop module type
Temperature controller

ENHANCED COMMUNICATION MODULE [PUMCM] (Mitsubishi's PLC Programless Communication)

DATA SHEET

PUMCM

PUMCM is the communication module to connect the module type temperature controller, PUM series, to Mitsubishi's PLC (MELSEC-Q/A/AnS/FX series) without program.

High-speed communication of maximum 230.4kbps can be performed via RS-232C, RS-422 or RS-485 interface. Also, maximum of 16 units (64 channels) of PUMA (control module) can be connected to one of this module, and maximum 8 units of this module can be connected to 1 communication port, and it realizes a labor saving wiring, simple engineering and small space.

FEATURES

I. Programless connection with Mitsubishi's PLC

1. RS-232C, RS-422 or RS-485 high-speed communication (max. 230.4 kbps)
2. Accessible to the almost all parameters of control module (PUMA/PUMB)
3. High-speed data loading and setting reflection by high-speed internal communication with connected control module (PUMA/B)
4. 1:N configuration is available, which maximum 8 units of this module can be connected to 1 communication port.

II. User-friendly structure and functions

1. Lateral connection to 1 unit of this module: Max. 16 units (64 channels) + event input/output module 16 units = total 32 units
Simple wiring for power supply and a labor saving wiring for communication by programless communication.
2. Detachable structure: Terminal block, main unit, and the base part.
 - Easy wiring with detachable terminal block
 - Main units exchangeable without re-wiring

SYSTEM SPECIFICATION

1. **Product type:** Multi-loop module type temperature controller
2. **Module type**
 - 1) Analog module: Total max. 16 units
 - a) Control module (4 loops)
 - b) Enhanced input/output (analog) module
 - Analog input/output module (input/output 4 points/unit)
 - Analog input module (input 4 points/unit)
 - Analog output module (output 4 points/unit)
 - 2) Enhanced input/output (digital) module:
 - Maximum 16 units
 - Event input/output module (input/output 8 points/unit)
 - 3) Enhanced communication module: 1 unit



3. Connecting method:

Lateral connecting with connectors
(For power supply and RS-485 communication, any one of connected modules is required to be connected)

4. No. of loop, input/output

- 1) Control loop: Max. 64
- 2) No. of input/output: DI 128 points / DO 128 points

ENHANCED COMMUNICATION MODULE SPECIFICATIONS (Mitsubishi's PLC programless communication)

1. General specification

- (1) Power supply: 24V DC $\pm 10\%$
- (2) Power consumption: Max. 3.2 W (135 mA)
[when 24V DC is applied]
- (3) Insulation resistance: 20M Ω or more (500V DC)
- (4) Withstand voltage:
 - Power supply \leftrightarrow loader communication
1000V AC 1 min.
 - Power supply \leftrightarrow RS-232C, RS-422, RS-485
1000V AC 1 min.
- (5) Applied standards:
 - UL, C-UL, CE marking, RoHS directive
 - [Pending for UL, C-UL marking]

2. Connected devices

• MELSEC-Q series

Device	Type	Communication port	
		CH1	CH2
Q-compatible serial communication unit	QJ71C24, QJ71C24N	RS-232C (D-sub 9P)	RS-422/485 (2-piece socket block)
	QJ71C24-R2, QJ71C24N-R2	RS-232C (D-sub 9P)	RS-232C (D-sub 9P)
	QJ71C24N-R4	RS-422/485 (2-piece plug-in connector socket block)	RS-422/485 (2-piece plug-in connector socket block)

• MELSEC-A/Ans series

Device	Type	Communication port	
		CH1	CH2
A-compatible computer link module	AJ71UC24	RS-232C(D-sub 9P) RS-422/485(terminal block)	—
AnS-compatible computer link module	A1SJ71UC24-R2	RS-232C (D-sub 9P)	—
	A1SJ71UC24-R4	RS-422/485 (terminal block)	—
	A1SJ71UC24-PRF	RS-232C (D-sub 9P)	—

• MELSEC-FX series

Device	Type	Communication port	
		CH1	CH2
Communication special adapter	FX0N-232ADP	RS-232C (D-sub 25P)	—
	FX2NC-232ADP	RS-232C (D-sub 9P)	—
	FX3U-232ADP	RS-232C (D-sub 9P)	—
		—	RS-232C (D-sub 9P)*1
	FX-232ADP	RS-232C (D-sub 25P)	—
	FX0N-485ADP	RS-485 (terminal block)	—
	FX2NC-485ADP	RS-485 (European terminal block)	—
	FX3U-485ADP	RS-485 (European terminal block)	—
		—	RS-485 (European terminal block)*1
FX-485ADP	RS-485 (terminal block)	—	
Enhanced board	FX1N-232-BD	RS-232C (D-sub 9P)	—
	FX2N-232-BD	RS-232C (D-sub 9P)	—
	FX3U-232-BD	RS-232C (D-sub 9P)	—
	FX1N-485-BD	RS-485 (European terminal block)	—
	FX3U-485-BD	RS-485 (European terminal block)	—

*1 When using it as CH2, FX3U-△-ADP should be connected to CH1 by using FX3U-□-BD or two of FX3U-△-ADP should be connected to CH1 by using an enhanced board, FX3U-CNV-BD (one of 232, 422, 485 or USB goes into □, and 232 or 485 goes into △).

Refer to [Data Communication Edition] in the FX SERIES USER'S MANUAL for details.

Connectable model types on FX series sequencer are shown below.

Type	Connection
FX2(FX), FX2C, FX2N, FX1N, FX2NC, FX1NC, FX3U, FX3UC	Connectable
FX1S, FX0N	Not connectable

3. Communication interface

3.1 Programless communication interface

Select ①, ② or ③ by the switch

① RS-422 interface

- (1) **Communication standards:** RS-422 compatible
- (2) **No. of port:** 1 port
- (3) **Communication, synchro method:**
4-wire, half duplex, asynchronous cycle
- (4) **Communication speed:**
9.6k, 19.2k, 38.4k, 57.6k, 115.2k, 230.4kbps
- (5) **Max. communication distance:**
MELSEC-Q series 1000m or less
MELSEC-A series 500m or less
MELSEC-FX series 500m or less
- (6) **Recommended cable:**
KFPEV-SB2P 0.5sq-equivalent / FUJI ELECTRIC CABLE CO., LTD
- (7) **Data format:** Start bit1, data bit 8,
Parity even/odd/none
Stop bit 1
- (8) **Insulation:** No insulation with any communication interface other than loader interface, Functional insulation with loader communication interface and other all signals

② RS-485 interface

- (1) **Communication standards:** RS-485 compatible
- (2) **No. of port:** 1 port
- (3) **Communication, synchro method:**
2-wire, half duplex, asynchronous cycle
- (4) **Communication speed:**
9.6k, 19.2k, 38.4k, 57.6k, 115.2k, 230.4kbps
- (5) **Max. communication distance:**
MELSEC-Q series 1000m or less
MELSEC-A series 500m or less
MELSEC-FX series 500m or less
- (6) **Recommended cable:**
KFPEV-SB2P 0.5sq / FUJI ELECTRIC CABLE CO., LTD
- (7) **Data format:** Start bit1, data bit 8,
Parity even/odd/none
Stop bit 1
- (8) **Insulation:** No insulation with any communication interface other than loader interface, Functional insulation with loader communication interface and other all signals

③ RS-232C interface

- (1) **Communication standards:** RS-232C compatible
- (2) **No. of port:** 1 port
- (3) **Communication, synchronous method:**
Half-duplex, asynchronous cycle
- (4) **Communication speed:**
9.6k, 19.2k, 38.4k, 57.6k, 115.2k, 230.4kbps
- (5) **Max. communication distance:** 15m
- (6) **Recommended cable:**
KFPEV-SB 1P 0.5sq-equivalent / FUJI

- ELECTRIC CABLE CO., LTD
- (7) **Data format:** Start bit1, data bit 8,
Parity even/odd/none
Stop bit 1
- (8) **Insulation:** No insulation with any communication interface other than loader communication interface, Functional insulation with loader communication interface and other all signals

3.2 Loader communication interface

- (1) **Communication standards:** RS-232C compatible
- (2) **No. of port:** 1 port
- (3) **Communication, synchro method:**
Half-duplex, asynchronous cycle
- (4) **Communication speed:** 19.2kbps (fixed)
- (5) **Data format:** Data bit 8, no parity
- (6) **Protocol:** Modbus RTU compatible
- (7) **Connection method:**
2.5 diameter mini-plug/jack
[on the front of module]
(Common cable with PXG, PXH)
- (8) **Insulation:** Functional insulation with any other signals

4. Display, configuration

- (1) **Display:** Status display LED
(2 colors × 2 points + 4points)
- (2) **Display contents:**
RUN/FAULT, internal communication status
Communication TX/RX (Port1),
Communication TX/RX (Port2)
- (3) **Setting device and setting contents**

Setting device		Setting contents
Front face	Rotary SW × 1	Programless communication station setting
Within the device	DIP SW (6bit) × 1	RS-232C/RS-422/RS485 Operation mode

5. Power outage

- (1) **Impact of power outage:**
Outage of 2ms or less; no impact
- (2) **Operation after power outage:**
Start from the first step (cold start)
- (3) **Memory backup:**
Nonvolatile memory (EEPROM)
(No. of update; 100,000)

6. Self diagnosis

Diagnosis method:
Program error monitoring by watch dog timer

7. Structure

- (1) **Installation method:**
DIN rail mounting or mounting with M3 screws inside a cabinet
- (2) **Dimensions:** 30 (W) × 100 (H) × 85 (D) mm (excluding terminal cover and projected part)
- (3) **Weight:** Approx. 200 g
- (4) **Extrenal terminal**
 - Programless communication interface:
Detachable terminal block (M3 screw × 20 terminals)
 - Power supply connection:
Terminal block on the base part (M3 screw × 2 terminals)
Power is supplied via side connectors in case of lateral connecting. (Max. 33 units)
 - Loader communication port:
2.5 diameter 3-pole mini-plug/jack [on the front of module]
- (5) **Case material:** Polyphenylene oxide (flame retardant grad: UL94V-0 equivalent)
- (6) **Case color:** Case ; red
Terminal, base part ; black
- (7) **Protection**
 - Body: IP20 grade protection (ventilation slits on the top and the bottom of body)
 - Terminal: IP00 grade protection, terminal cover is available as an option

8. Normal operating condition

- (1) **Ambient temperature*:** -10 to 50°C
* "Ambient temperature" is the temperature underneath the controller inside the equipment or the cabinet where the controller is installed.
- (2) **Ambient humidity:** 90% RH or less (non condensing)
- (3) **Vibration:** 10 to 70Hz, 9.8m/s² (1G) or less

9. Transporting, storage condition (packing condition)

- (1) **Storage temperature:** -20 to 60°C
- (2) **Ambient humidity:** 90%RH or less (no condensing)
- (3) **Vibration:** 10 to 70Hz, 9.8m/s² (1G) or less
- (4) **Shock:** 294m/s² (30G) or less

10. Packing list

Temperature controller: 1unit
Instruction manual: 1 copy

11. Loader software

- (1) **Distribution medium:**
Free download from Fuji Electric Systems HP (<http://www.fic-net.jp>)
- (2) **Recommended operating environments**
 - PC: DOS/V (PC-AT compatible)
 - OS: Windows XP (operation confirmed in Japanese / English)
 - RAM: 256M bytes or more
 - Free space on the hardware: 500M bytes or more
 - Display resolution: 1024 × 768 or over
 - Serial interface: RS-232C 1 port (without RS-232C, USB serial converter cable required)
- (3) **Connection with PUM**
Via loader interface on the front face of module (special cable available from Fuji is required)

CODE SYMBOLS

[Enhanced communication module]

		Digit → 1 2 3 4 5 6 7 8 9 10									
		PUM				YY	1	-	0		
Digit	Description										
4	< Module type > Enhanced communication module				C						
5	< Communication functions > Mitsubishi's PLC programless communication					M					
10	< Operation manual > Japanese English									A B	

		Digit → 1 2 3 4 5 6 7 8							
		PUMZ		*					
Digit	Description								
6	DIN rail mounting end plate							A	0 2
7	Connecting terminal cover (right & left 1 set)							A	0 3
8	Front face screw terminal cover							A	0 4
	Loader connecting cable (RS-232C)							L	0 1

[Table 1] Insulation block diagram

Power	RS-323C
Loader communication	RS-422 RS-485

== Functional insulation (1000VAC) — Functional insulation (500VAC)

OUTLINE DIAGRAM (Unit : mm)

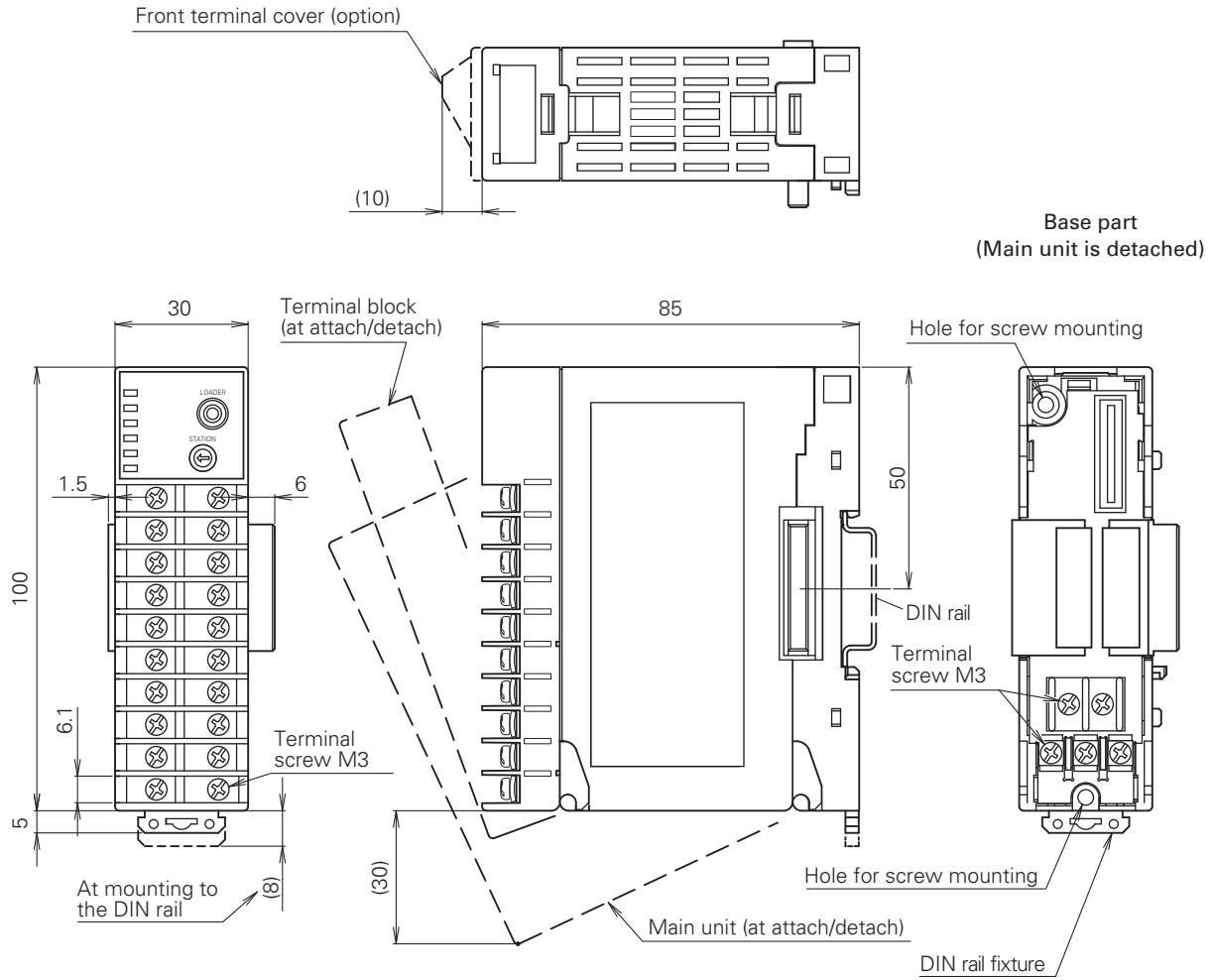

Dimensions for Screw Mounting

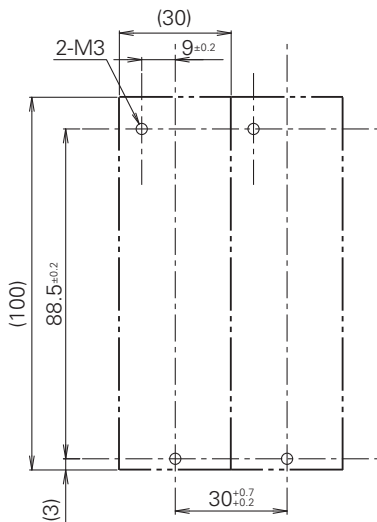

Notice at the Installation

Please keep the distance of 30mm from this instrument to radiate.
(50mm is recommended.)

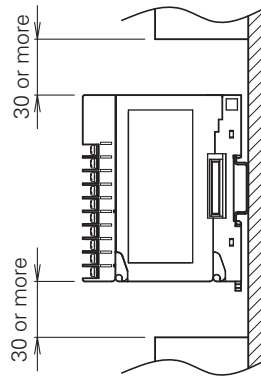

TERMINAL CONNECTION DIAGRAM

Loader interface (RS-232C)

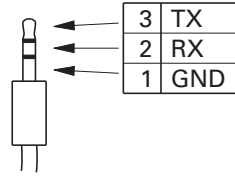

φ2.5 3-pole miniature plug

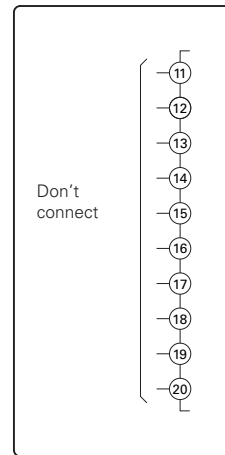
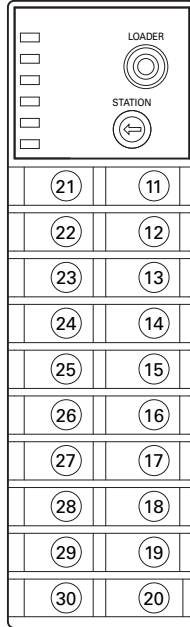
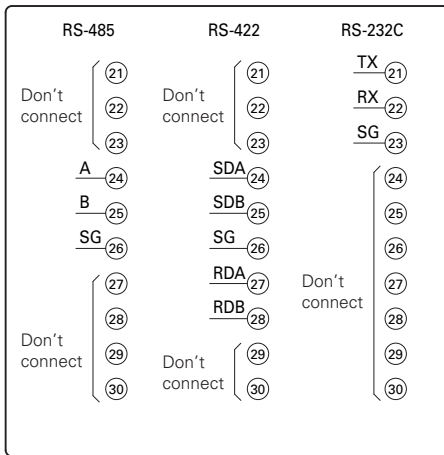

Base part

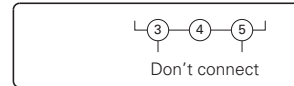
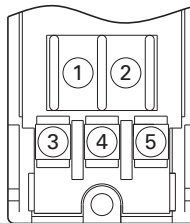

Programless communication module status

Contents	Reading out/Writing data setting range	Factory-set value	Register No.
Setting faults	0101h: St. No. configuration SW is invalid value	—	30232
	0102h: DIP SW is invalid value		
	0201h: PLC communication speed is invalid value		
	0202h: PLC communication data length is invalid value		
	0203h: MC protocol is invalid value		
	0204h: PLC communication inter-cycle time is invalid value		
	0205h: PLC communication starting time is invalid value		
	0206h: PLC response monitoring time is invalid value		
	0207h: Number of PLC communication retry is invalid value		
	0208h: Connection method is invalid value		
	0209h: Number of connected units is invalid value		
	020Ah: Operation at PLC communication fault is invalid value		
	020Ch: MC protocol frame type is invalid value		
	0210h: Setting area device type is invalid value		
	0211h: Setting area device size is invalid value		
0212h: Monitor area device type is invalid value			
0213h: Monitor area device size is invalid value			
0214h: Setting area detail (The 1 st word) is invalid value			
0215h: Monitor area detail (The 1 st word) is invalid value			

Communication status with PLC

Contents	Reading out/Writing data setting range	Factory-set value	Register No.
PLC error counter	0 → 1 → ... → 65535 → 0 → 1 → ...times	—	31001
PLC error code	0000h to 0042h: Error code of A compatible 1C frame	—	31002
	0100h: Command message timeout		
	0101h: Response message timeout		
	0102h: Sum check code error		
	0103h: Header format error		
	0104h: ASCII code error		
	0110h: Hardware failure 1		
	0111h: Hardware failure 2		
	0120h: Continuous reception error		
	7000h to 7FFFh: Error code of QJ71C24N		
PLC sending counter	0 → 1 → ... → 65535 → 0 → 1 → ...times	—	31003
PLC receiving counter	0 → 1 → ... → 65535 → 0 → 1 → ...times	—	31004
PLC inter-cycle time monitor	0 to 65535ms	—	31007
PLC inter-cycle time over counter	0 → 1 → ... → 65535 → 0 → 1 → ...times	—	31008

PLC communication setting

Contents	Reading out/Writing data setting range	Factory-set value	Register No.
PLC communication speed	0005h: 9600bps 0007h: 19200bps 0009h: 38400bps 000Ah: 57600bps 000Bh: 115200bps 000Ch: 230400bps	000Bh	40001
PLC transmission setting	b0: OFF (fixed) b1: Data bit (ON: 8bits (fixed)) b2: Parity bit (OFF: No, ON: Yes) b3: Odd/Even parity (OFF: Odd, ON: Even) b4: Stop bit (OFF: 1, ON: 2) b5 to b15: OFF (fixed)	000Eh	40002
MC protocol	2: Type2 4: Type 4 5: Type5	5	40003
PLC communication inter-cycle time	0 to 5000ms	100	40004
PLC communication starting time	1 to 255sec	1	40005
PLC response monitoring time	10 to 10000ms	200	40006
Number of retry times	0 to 10 times	0	40007
Connection method	0=1:1 connection 1=1:N connection	0	40008
No. of connected units	1 to 8	1	40009
MC protocol frame type	0: QnA compatible 4C frame 1: A compatible 1C frame	0	40019

Programless communication module

Contents	Reading out/Writing data setting range	Factory-set value	Register No.
Operation selection at programless communication fault	0000h: RUN 0001h: STOP	0001h	40010

Memory configuration (Setting area)			
Contents	Reading out/Writing data setting range	Factory-set value	Register No.
Setting area device type	00A8h: Data register (D) 00B4h: Link register (W) 00AFh: File register (R) 00B0h: File register [for sequence No. access] (ZR)	00A8h	40011
Setting area start address (lower)	Addressable range: according to PLC (product of Mitsubishi) setting	1000	40012
Setting area start address (upper)	Addressable range: according to PLC (product of Mitsubishi) setting	0	40013
Setting area device size	0 to 712	0	40014
Setting area entry St. No. (The 1 st word)	0: Not used 1 to 16: Control/Analog module 17 to 32: Event module	0	41001
Setting area entry register No. (The 1 st word)	0, 40000 to 49999 (Note1)	0	41002
Setting area entry St. No. (The 2 nd word)	0: Not used 1 to 16: Control/Analog module 17 to 32: Event module	0	41003
Setting area entry register No. (The 2 nd word)	0, 40000 to 49999 (Note1)	0	41004
. . .			
Setting area entry St. No. (The 711 th word)	0: Not used 1 to 16: Control/Analog module 17 to 32: Event module	0	42421
Setting area entry register No. (The 711 th word)	0, 40000 to 49999 (Note1)	0	42422
Setting area entry St. No. (The 712 th word)	0: Not used 1 to 16: Control/Analog module 17 to 32: Event module	0	42423
Setting area entry register No. (The 712 th word)	0, 40000 to 49999 (Note1)	0	42424

Note 1: Only the address written in " setting/monitor area register number" (control module 5-6, event module 5-7) can be set. However, the parameters marked * in the "Entry ban" column cannot be set.

Memory configuration (Monitor area)			
Contents	Reading out/Writing data setting range	Factory-set value	Register No.
Monitor area device type	00A8h: Data register (D) 00B4h: Link register (W) 00AFh: File register (R) 00B0h: File register [for sequence No. access] (ZR)	00A8h	40015
Monitor area start address (lower)	Addressable range: according to PLC (product of Mitsubishi) setting	0	40016
Monitor area start address (upper)	Addressable range: according to PLC (product of Mitsubishi) setting	0	40017
Monitor area device size	0 to 712	0	40018
Monitor area entry St. No. (The 1 st word)	0: Not used 1 to 16: Control/Analog module 17 to 32: Event module 128: Programless communication module	0	43001
Monitor area entry register No. (The 1 st word)	0, 30000 to 49999 (Note2)	0	43002
Monitor area entry St. No. (The 2 nd word)	0: Not used 1 to 16: Control/Analog module 17 to 32: Event module 128: Programless communication module	0	43003
Monitor area entry register No. (The 2 nd word)	0, 30000 to 49999 (Note2)	0	43004
. . .			
Monitor area entry St. No. (The 711 th word)	0: Not used 1 to 16: Control/Analog module 17 to 32: Event module 128: Programless communication module	0	44421
Monitor area entry register No. (The 711 th word)	0, 30000 to 49999 (Note2)	0	44422
Monitor area entry St. No. (The 712 th word)	0: Not used 1 to 16: Control/Analog module 17 to 32: Event module 128: Programless communication module	0	44423
Monitor area entry register No. (The 712 th word)	0, 30000 to 49999 (Note2)	0	44424

Note 2: Only the address written in " setting/monitor area register number" (control module 5-6, event module 5-7) can be set. However, the parameters marked * in the "Entry ban" column cannot be set.

⚠ Caution on Safety

*Before using this product, be sure to read its instruction manual in advance.



Grobal Sales Section
Instrumentation & Sensors Planning Dept.
 1, Fuji-machi, Hino-city, Tokyo 191-8502, Japan
<http://www.fujielectric.com>
 Phone: +81-42-514-8930 Fax: +81-42-583-8275
<http://www.fujielectric.com/products/instruments/>