

# Instruction Manual (Installation)



Multi-loop module type Temperature Controller  
Control Module

Model : PUMA/B

Fuji Electric Co., Ltd.

INP-TN1PUMAa-E

Thank you for purchasing the Fuji module type temperature controller. Once you have confirmed that this is the product you ordered, please use it in accordance with the following instructions. For detailed information on operating this equipment, please refer to the separate user's manual. In addition, please keep this instruction manual within easy reach of the actual person using this equipment.

## CAUTION

The contents of this manual are subject to change without notice. This manual is compiled with possible care for the purpose of accuracy, however, Fuji Electric shall not be held liable for any damages, including indirect damage, caused by typographical errors, absence of information or use of information in this manual.

### Confirming Specifications and Accessories

Before using the product, confirm that it matches the type ordered. (For model code, please refer to page 4.) Confirm that all of the following accessories are included.

Temperature Controller Control Module	1 Unit
Instruction Manual	1 copy
I/V unit (250 ohm resistance)	
	1 unit per voltage/current input

### Related Information

Refer to "Module Type Temperature Controller Control Module User's Manual" for details about the items described in this manual.

Content	Material name	Material No.
Specification	Catalog	ECNO 1162
Operating instruction	Control module User's manual	INP-TN5A0198-E
Tool	PUM parameter loader	INP-TN5A0201-E

## Please Read First (Safety Warnings)

Please read this section thoroughly before using and observe the mentioned safety warnings fully. Safety warnings are categorized as "Warning" or "Caution".

⚠ Caution	Improper use of the equipment may result in death or serious injuries.
⚠ Warning	Improper use of the equipment may cause injury to the user or property damage.

## 1 Warning

### 1-1 Installation and Wiring

- This equipment is intended to be used under the following conditions.
- |                       |   |
|-----------------------|---|
| Ambient temperature   | -10 to 50 degree C                            |
| Ambient humidity      | 90% RH or below (with no condensation)        |
| Vibration             | 10 to 70Hz less than 9.8m/s <sup>2</sup> (1G) |
| Warm-up time          | 30 min. or more                               |
| Installation category | IEC1010-1: class II                           |
| Pollution level       | IEC1010-1: degree 2                           |
- Between the temperature sensor and the location where the voltage reaches or generates the values described below, secure clearance space and creepage distance as shown in the table below. If such space cannot be secured, the EN61010 safety compliance may become invalid

Voltage used or generated by any assemblies	Clearance Space [mm]	Creepage Space [mm]
Up to 50 Vrms or Vdc	0.2	1.2
Up to 100 Vrms or Vdc	0.2	1.4
Up to 150 Vrms or Vdc	0.5	1.6
Up to 300 Vrms or Vdc	1.5	3.0
Above 300 Vrms or Vdc	Please consult our distributor	

- For the above, if voltage exceeds 50Vdc (called danger voltage), basic insulation is required between the earth and all terminals of the equipment. Note that the insulation class for this equipment is as follows. Before installing, please confirm that the insulation class for the equipment meets usage requirements.

Power	PV1 Input
Loader communication port	PV2 Input
RS-485 communication port	PV3 Input
CT Input (CT1A, B - CT4A, B)	PV4 Input
OUT1 (relay contact output)	OUT1 (SSR drive, current)
OUT2 (relay contact output)	OUT2 (SSR drive, current)
OUT3 (relay contact output)	OUT3 (SSR drive, current)
OUT4 (relay contact output)	OUT4 (SSR drive, current)

— Basic insulation (1500Vac)  
 — Functional insulation (1000Vac)  
 — Functional insulation (500Vac)

- In cases where damage or problems with this equipment may lead to serious accidents, install appropriate external protective circuits.
- To prevent damage and failure of the equipment, provide the rated power voltage.
- To prevent electric shock and equipment failure, do not turn the power ON until all wiring is complete.
- Before turning the power ON, confirm that clearance space has been secured to prevent shock or fire.
- Do not touch the terminal while the machine is ON. Doing so risks shock or equipment errors.
- Never disassemble, convert, modify or repair this equipment. Doing so risks abnormal operation, shock or fire.

## 1-2

## Maintenance

- When installing or removing the equipment, turn the power OFF. Otherwise, shock, operational errors or failures may be caused.
- Periodic maintenance is recommended for continuous and safe use of this equipment.
- Some parts installed on this equipment have a limited life and/or may deteriorate with age.
- The warranty period for this unit (including accessories) is one year, if the product is used properly.

## 2

## ⚠ Caution

### 2-1

### Cautions when Installing

- Please avoid installing in the following locations.
- Locations in which the ambient temperature falls outside the range of 0 to 50 degrees C when equipment is in use.
  - Locations in which the ambient humidity falls outside the range of 45 to 85% RH when equipment is in use.
  - Locations with rapid temperature changes, leading to dew condensation
  - Locations with corrosive gases (especially sulfide gas, ammonia, etc.) or flammable gases.
  - Locations with vibration or shock directly.
  - Locations in contact with water, oil, chemicals, steam or hot water. (If the equipment gets wet, there is a risk of electric shock or fire, so have it inspected by Fuji distributor.)
  - Locations with high concentrations of atmospheric dust, salt or iron particles.
  - Locations with large inductive interference, resulting in static electricity, magnetic fields or noise.
  - Locations in direct sunlight.
  - Locations that build up heat from radiant heat sources, etc.

### 2-2

### Cautions when Mounting to Cabinets / DIN rails

- In case of mounting the temperature controllers to DIN rails, remember to push up the locking tabs to fasten the controllers onto DIN rail.
- To connect controllers, first release all locking tabs. Then, connect controllers and push up all locking tabs. Make sure that all locking tabs are fastened.
- Never fail to turn the power OFF, before detaching the terminal block or removing the main unit from the base part.
- In order to aid heat dissipation, do not block the top and the bottom of the equipment.
- When mounting / dismantling controllers to / from DIN rails, 30mm of clearance above and under the controllers should be provided.
- Use terminal screws in this product only.

### 2-3

### Cautions for Wiring

- For thermocouple input, use the designated compensation lead. For resistance bulb input, use wires with small lead wire resistance and without any resistance difference among three wires.
- To avoid the influence of inductive noise, input signal wires should be separated from electric power lines or load lines.
- Input signal wire and output signal wire should be separated from each other. And both should be shielded.
- If the output operation frequency is high, selecting a SSR/SSC drive output type is recommended.  
 [Proportionate cycles] Relay output: 30 sec. or more, SSR/SSC drive output: 1sec. or more
- When inductive loads such as magnetic opening/closing equipment, etc. as relay output equipment are connected, use of "Z-trap," manufactured by Fuji Electric Device Technology Co., Ltd., is recommended in order to protect the contacts against opening/closing surges and to ensure long-term use.  
 Model names : ENE241D-07A (For 100V power voltage)  
                   : ENE471D-07A (For 200V power voltage)
- Attachment position : Please connect between the relay control output contacts.
- To comply with CE marking (EMC), we recommend to attach ferrite core to communication cable and power cable.
- For wiring to the terminal block, apply crimp type terminals size M3.  
 Screw size : M3 x 7 (with square washer)  
 Screw tightening torque : 0.78N-m (8kgf-cm)

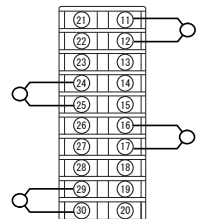

Z-trap connecting diagram

### 2-4

### Error Operation

- The alarm function does not work properly when an error occurs unless the settings are made correctly. Always verify its setting before operation.
- In case of error input, PWR LED will flash. When replacing the sensor, make sure to turn the power OFF.

- Please do not wipe the equipment with organic solvents such as alcohol or benzene, etc. If wiping is necessary, use a neutral cleaning agent.
- Do not use mobile phones near this equipment (within 50cm). Otherwise a malfunction may result.
- Malfunctions may occur if the equipment is used near a radio, TV, or wireless device.
- This equipment requires approx. 20 seconds before it starts to output.
- Before installing and wiring, take necessary measures for electrostatic discharge (ESD).

## Part names and Functions

### - Main unit

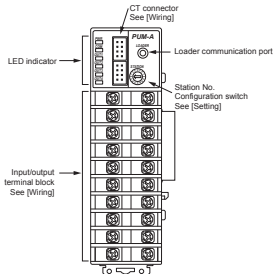

### - Base part

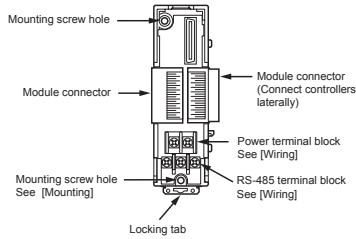

### LED indicator

Six LED lamps indicate the following operational conditions.

LED	LED Status	Color	Operational condition
PWR	Illuminated	green	Normal operation (Slave station of internal communication)
	Blinking	green	Normal operation (Master station of internal communication)
	Illuminated	red	System fault (A/D converter error, internal communication error)
	Blinking	red	Input error
COM	Illuminated	green	RS-485 receiving
	Illuminated	orange	RS-485 transmitting
OUT1 - 4	Illuminated	green	Corresponding channel outputting
	Illuminated	red	Corresponding channel input error

- Actions to be displayed for COM and OUT1 - 4 can be allocated by programming.

## Setting

### - Setting Station No.

Set Station No. of each controller before mounting. Apply a fine tip flat-head screwdriver to turn the Station No. configuration switch.

Rotary SW setting	Station No.
0	1
1	2
2	3
3	4
4	5
5	6
6	7
7	8
8	9
9	10
A	11
B	12
C	13
D	14
E	15
F	16

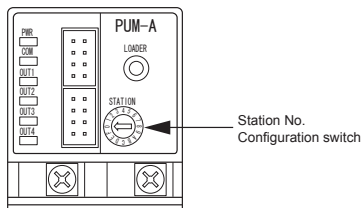

- Each of connected controllers must have a different Station No. from other controllers. Duplicate Station No. may cause malfunction of the equipment.

## Mounting

### - Dimensions

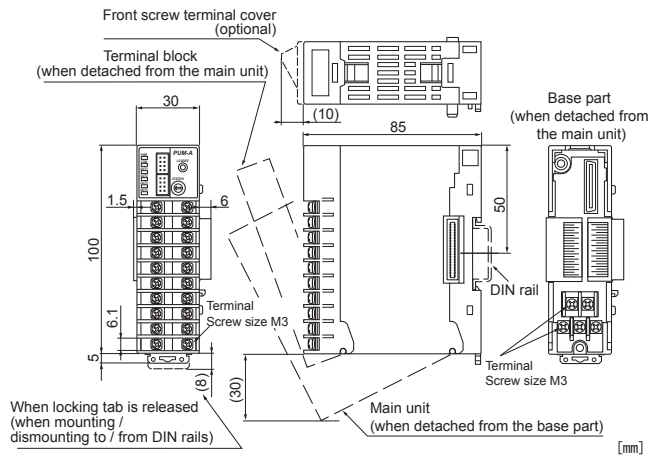

### Cautions when mounting

In order to aid heat dissipation, 30mm of clearance (50mm recommended) above and under the controllers should be provided.

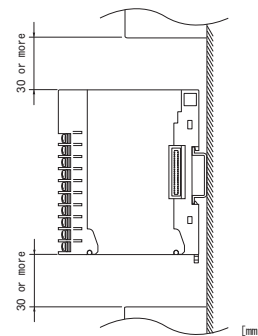

### - Mounting to DIN rails

1. Pull down the locking tab of the base part. Hook the back of the controller onto the upper part of DIN rail.
2. Push the controller in the direction of arrow 2.

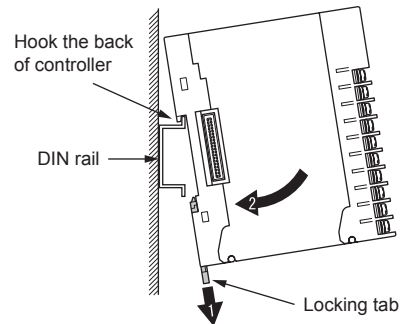

3. Push up the locking tab to fasten the controller onto DIN rail.
- When connecting controllers after mounting to DIN rail, push up the locking tab after doing so.

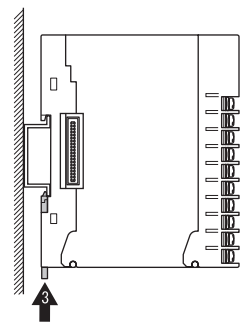

### - Attaching end plates

When mounting controllers to DIN rails, we recommend to attach side connecting terminal covers (right and left 1set), then end plates (optional) to the ends of the rightmost and leftmost controllers.

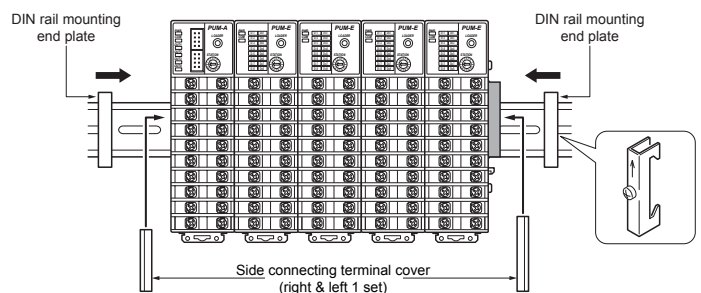

### - Fixing with screws

When mounting controllers inside a cabinet with screws, connect the base parts of controllers first.

- Fixing screws are not included. Please prepare screws as required.

1. Refer to the figure below for the mounting screw hole size to decide the mounting position.

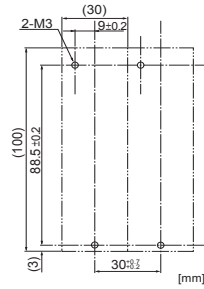

2. Remove the main unit from the base part. See [How to detach the base part]

3. Connect base parts. Push up to fasten all the locking tabs.

4. Fixate the base parts onto the mounting position inside the cabinet with screws.
5. Attach the main unit to the base parts.

### - Connecting controllers

1. Check that locking tabs are pulled down (released).
2. Connect controllers with each other using side connectors.

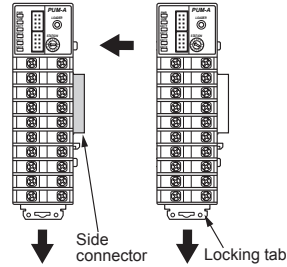

3. After mounting controllers onto DIN rail, make sure to push up all locking tabs. Controllers are fastened to DIN rail and to each other.
4. All connected controllers are connected to power supply and RS-485 via side connectors if one of controllers is directly connected to them.

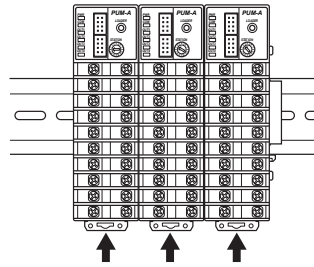

### How to detach the base part

1. Press the lock lever on the top of the main unit.
2. Pull down the upper part of main unit.
3. Detach the cutout on the lower end of back of main unit from the projection on the base part.

- When attaching the main unit to the base part, take the reverse procedure to removing the main unit from the base part.
- Make sure that the lock lever of the main unit is fitted into the base part.

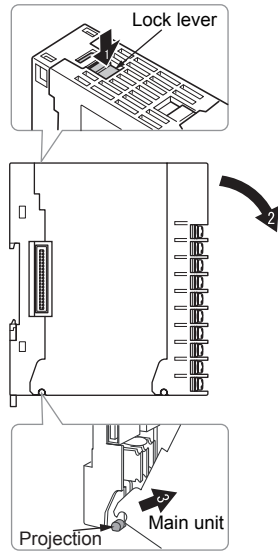

## Wiring

### - Front terminal block (1ch type / 2ch)

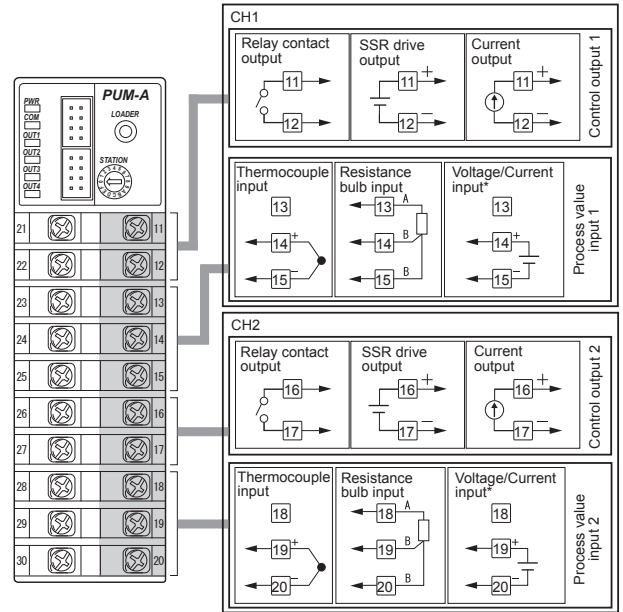

\*In case of current input, attach I/V unit which comes with the controller to the voltage input terminal.

### - Front terminal block (3ch, 4ch)

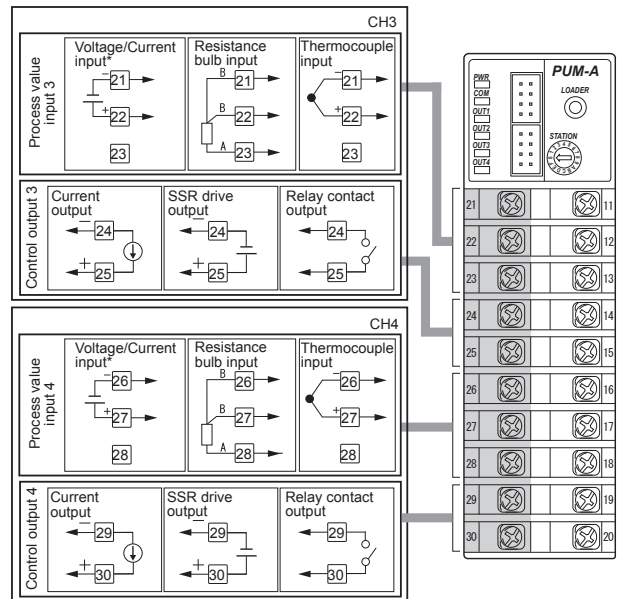

\*In case of current input, attach I/V unit which comes with the controller to the voltage input terminal.

### - Base part (power terminal, RS-485 terminal)

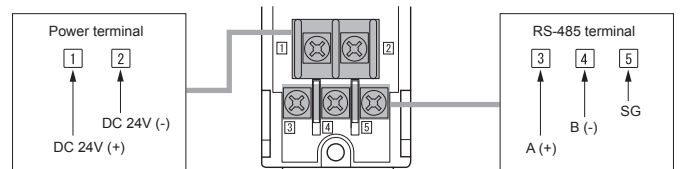

All connected controllers are connected to power supply and RS-485 via side connectors if one of controllers is directly connected to them.

### - CT input terminal

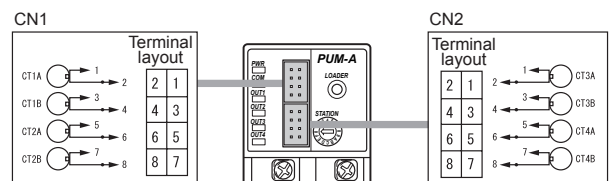

\*Pin No. 2, 4, 6, 8 of CN1 and CN2 are connected inside the equipment.  
\*CN2 cannot be used for PUMB.

# Specification

## General Specification

Power Supply	: DC24V±10%
Power Consumption	: Maximum 3.2W (135mA) [when DC24V is applied]
Dimensions	: 30 (W)×100 (H)×85 (D) mm (excluding terminal cover and projection)
Weight	: Approx.200g
Installation method	: DIN rail mounting or mounting inside a cabinet with M3 screws
Ambient temperature*	: -10 to 50 degrees C
	* "Ambient temperature" is the temperature underneath the controller inside the equipment or the cabinet where the controller is installed.
Ambient humidity	: 90% RH or less (non condensing)

## Process value input

No. of input	: 2 or 4 points (1point/channel)
Input signal	: Thermocouple K, J, T, E, R, B, S, N, PL-II
	Resistance bulb Pt100, JPt100
	DC voltage or DC current : 0 to 5Vdc, 0 to 10Vdc, 2 to 10Vdc, 0 to 20mAdc, 4 to 20mAdc
Input impedance	: Thermocouple input, voltage input : 1M ohm or more
	- Voltage input (V) : Approx. 1M ohm
	- Current input : 250 ohm
Signal source resistance	: Thermocouple : 0.3%FS ± 1 digit per 100 ohm
	- Voltage input (V) : 0.3%FS ± 1 digit per 500 ohm
Allowable wiring resistance-	Resistance bulb input : 10 ohm or less per wire

## Heater break detector (CT) input

No. of input	: 4 or 8 points (2 points/control channel)
Input type	: Single-phase type CT/point : 1 to 30A : CTL-6-S-H 20 to 50A : CTL-12-S36-8
Connection method	: Special connector for Heater break detector (optional)

## Control output

No. of output	: 2 points (1 point/control channel) or 4 points (2 points/control channel)
Control output behavior	: Heat (reverse action) or Cool (direct action) or Heat/cool (control output 2points/control channel required)
Output type	a) Relay contact output
	- Proportion cycle : 1 to 150 sec.
	- Contact structure : SPST contact
	- Contact capacity : 220Vac / 30Vdc, 3A (resistance load) 220Vac / 30Vdc, 1A (inductive load)
	- Minimum switching current : 100mA (24Vdc)
	- Mechanical life : 20,000,000 switching or more (100/min.)
	- Electric life : 100,000 switching or more (rated load)
	b) SSR/SSC drive output
	- Proportion cycle : 1 to 150 sec.
	- Minimum resolution : 5ms
	- ON Voltage : 10Vdc (8 to 12Vdc)
	- OFF Voltage : 0.5Vdc or less
	- Maximum Current : 20mAdc (per point)
	- Load resistance : 500 ohm or more
	c) Current output (4-20mAdc, 0-20mAdc)
	- Actual output range : 0mA to 20.6mAdc
	- Accuracy : ±0.3%FS (1mA or less : ±5%FS)
	- Linearity : ±0.3%FS (1mA or less : ±5%FS)
	- Resolution : 5000 or more
	- Ripple current : P-P0.3mA or less
	- Load resistance : 300 ohm or less

## Analog re-transmission output

No. of output	: 2 points (OUT3, OUT4 applied)
Output type	: Current output (4-20mAdc, 0-20mAdc)

## Communication functions

RS-485 interface	
Communication standard	: RS-485
Communication, synchro method	: Two-wire, half-duplex, asynchronous cycle
Communication speed	: 9.6k, 19.2k, 38.4k, 115.2kbps
Data form	: data bit ; 8, parity : even/odd/none
Communication distance	: 1km (38.4kbps or less), 250m (115.2kbps)
Connectable units	: 33 units (both master and slave units included) (32 units if any modules other than PUM series is included in slaves)
Protocol	: Modbus RTU compatible
Loader (RS-232C) interface	
Communication standard	: RS-232C
Communication, synchro method	: Half-duplex, asynchronous cycle
Communication speed	: 19.2kbps (fixed)
Data form	: data bit 8, no parity
Protocol	: Modbus RTU compatible
Protocol	: Modbus RTU compatible

## Crimp terminal size

Please prepare power cables and crimp terminals of the size indicated below.

Power cable

Cable type	Size
Thermocouple (Compensation lead wire)	1.25mm <sup>2</sup> or less
Power supply	1.25mm <sup>2</sup> or less

Crimp terminal

Cable size	Screw tightening torque
0.25 to 1.25mm <sup>2</sup>	0.8Nm

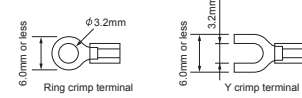

## Model code

### Control module (4ch)

1	2	3	4	5	6	7	8	9	10	11	12	13	Description	
P	U	M					1	-	0			0	0	<b>Module type</b>
A														4ch control module
														<b>Input type</b>
T														Thermocouple / resistance bulb [all channels]
A														Voltage / current [all channels]
C														Thermocouple / resistance bulb [ch1,2], voltage / current [ch3,4]
														<b>OUT1,2 output type</b>
A														Relay output
C														SSR drive output
E														Current output
														<b>OUT3,4 output type</b>
A														Relay output
C														SSR drive output
E														Current output
														<b>Operation Manual</b>
									A					Japanese
									B					English
														<b>Option 1</b>
									Y					Not fitted
									C					CT input (8 points)

### Control module (2ch)

1	2	3	4	5	6	7	8	9	10	11	12	13	Description	
P	U	M					1	-	0			0	0	<b>Module type</b>
B														2ch control module
														<b>Input type</b>
T														Thermocouple / resistance bulb [all channels]
A														Voltage / current [all channels]
														<b>OUT1,2 output type</b>
A														Relay output
C														SSR drive output
E														Current output
														<b>OUT3,4 output type</b>
														Not fitted
									A					Relay output
									C					SSR drive output
									E					Current output
														<b>Operation Manual</b>
									A					Japanese
									B					English
														<b>Option 1</b>
									Y					Not fitted
									C					CT input (4 points)

## Accessories (optional)

1	2	3	4	5	6	7	8	Description			
P	U	M	Z	*				A	0	1	RS-485 terminating resistance
								A	0	2	DIN rail mounting end plate
								A	0	3	Side connecting terminal cover (right & left 1 set)
								A	0	4	Front face screw terminal cover
								L	0	1	Loader connecting cable (RS-232C)
								C	0	1	CT input terminal cable (for 4 points) [l=1m]
								C	0	3	CT input terminal cable (for 4 points) [l=3m]
								C	0	5	CT input terminal cable (for 4 points) [l=5m]
								C	T	1	CT for 1 to 30A (CTL-6-S-H)
								C	T	2	CT for 2 to 50A (CTL-12-S36-8)

## Fuji Electric Co., Ltd.

### International Sales Div Sales Group

Gate City Ohsaki, East Tower, 11-2, Osaki 1-chome,  
Shinagawa-ku, Tokyo 141-0032, Japan  
http://www.fujielectric.com  
Phone: 81-3-5435-7280, 7281 Fax: 81-3-5435-7425  
http://www.fujielectric.com/products/instruments/