

# Instruction Manual (Installation)



Multi-loop module type Temperature Controller  
Enhanced Communication Module  
(Mitsubishi's programless communication)

**Model: PUMCM**

Fuji Electric Co., Ltd.

INP-TN1PUMCM-E

Thank you for purchasing the Fuji module type temperature controller. Once you have confirmed that this is the product you ordered, please use it in accordance with the following instructions.

For detailed information on operating this equipment, please refer to the separate user's manual.

In addition, please keep this instruction manual within easy reach of the actual person using this equipment.

## CAUTION

The contents of this manual are subjected to change without notice. This manual is compiled with possible care in the interests of accuracy, however, Fuji Electric Systems shall not be held liable for any damages, including indirect damage, caused by typographical errors, absence of information or use of information in this manual.

### Confirming Specifications and Accessories

Before using the product, confirm that it matches the type ordered. (Refer to page 4 for model codes.) Confirm that all of the following accessories are included.

Temperature Controller Enhanced Communication Module (PLC Programless Communication)	1 Unit
Instruction Manual	1 Copy

### Related Information

Refer to "Module Type Temperature Controller Enhanced Communication Module (Mitsubishi's PLC Programless Communication) User's Manual" for details about the items described in this manual.

Content	Material name	Material No.
Specification	Catalog	ECNO 1162
Operating instruction	Mitsubishi's PLC Programless Communication Module User's manual	INP-TN5A0202-E
Tool	PUM parameter loader	INP-TN5A0201-E

## Please Read First (Safety Warnings)

Please read this section thoroughly before using and observe the mentioned safety warnings fully. Safety warnings are categorized as "Warning", "Caution" or "Risk of Electrical Shock".

Warning	Improper use of the equipment may result in death or serious injuries.
Caution	Improper use of the equipment may cause injury or property damage.
Risk of Electrical Shock	Indicates that a risk of electrical shock is present and the associated warning should be observed.

## 1 Warning

### 1-1 Installation and Wiring

- This equipment intended to be used under the following conditions.

Ambient temperature	-10 to 50 degree C
Ambient humidity	90% RH or below (with no condensation)
Vibration	10 to 70Hz less than 9.8m/s <sup>2</sup> (1G)
Warm-up time	30 min. or more
Installation category	IEC1010-1: class II
Pollution level	IEC1010-1: degree 2

- The insulation class of the equipment is as below. Before installing, confirm that the insulation class for the equipment meets usage requirements.

Power source	RS-232C communication
Loader communication	RS-422 communication

—— Functional insulation (AC1000V)      ——— Functional insulation (AC500V)

- In cases where damages or problems with this equipment may lead to serious accidents, install appropriate external protective circuit.
- For damage and failure prevention of the equipment, provide the rated power voltage.
- To prevent electric shock and equipment failure, do not turn the power ON until all wiring is completed.
- Before turning the power ON, make sure clearance space has been secured for shock or fire prevention.
- Do not touch the terminal while the machine is ON. There are risks of shock or equipment errors.
- Never disassemble, convert, modify or repair this equipment. There are risks of abnormal operation, shock or fire.
- All of the wiring should be class 1 type wiring or the low voltage wires are routed separately from the hazardous voltage wires to ensure separation of circuits.

- When using a AWG-16 cable, you should use the crimp terminal that material thickness is 0.9mm or less.

## 1-2 Maintenance

- Turn OFF the power when installing or removing the equipment. It may cause shock, abnormal operation, or equipment failure.
- Periodic maintenance is recommended for continuous and safe use of this equipment.
- Some parts installed on this equipment have a limited life and/or may deteriorate with age.
- The warranty period for this unit (including accessories) is one year with appropriate use.

## 2 Caution

### 2-1 Cautions when Installing

For install in UL listed enclosure only. Please avoid installing in the following locations.

- Where the ambient temperature is beyond the range of 0 to 50 degree C when the equipment is in use.
- Where the ambient humidity is beyond the range of 45 to 85% RH when the equipment is in use.
- With rapid temperature changes, leading to dew condensation.
- Where corrosive gas (sulfide gas, ammonia, etc., especially) or farmable gas is generated.
- With direct vibration or shock to the equipment.
- Where contacts with water, oil, chemicals, steam or hot water. (If the equipment gets wet, since there is a risk of electric leakage or fire, have it inspected by Fuji distributor.)
- With high concentration of atmospheric dust, salt or iron particles.
- With inductive interference, resulting in static electricity, magnetic fields or noise.
- In direct sunlight.
- Where accumulation of heat due to radiant heat is generated.
- A switch or circuit Breaker shall be included in the building installation. Please be it in close proximity to the equipment and within easy reach of the operator, and mark it as the disconnecting device for the equipment.

### 2-2 Cautions when Mounting to Cabinets / DIN rails

- After mounting modules onto DIN rails, make sure to fasten it firmly by pushing up the locking tabs.
- When connecting modules, first, connect them with release of all modules' locking tabs, and then push all of them up to lock.
- Make sure to turn the power OFF, when removing the front terminal block from the main body or removing the main body from the base part.
- In order not to prevent heat dissipation, do not block the air vents on the top and bottom of the equipment.
- For mounting / dismantling modules to / from DIN rails, space more than 30mm should be provided.
- Use attached screws to the equipment only.

### 2-3 Cautions for Wiring

- For wiring to the terminal block, use solderless terminals of screw size M3. The screw size of the terminal block: M3 x 7 (with a square washer) Cramp torque: 0.78N-m (8kgf-cm)
- To avoid the influence of inductive noise, signal wires should be separated from electric power lines or load lines.
- If you use RS-232C communication, use it with attaching the noise filter to AC power line. (This is not necessary if implementing the complete preparation for noise of power line.)
- To comply with CE marking (EMC), attaching ferritic cores to the communication cable and the power supply cable is recommended.

### 2-4 Error Operation

- The alarm function does not work properly when an error occurs unless the correct settings are made. Make sure to verify its setting prior to starting operation.

### 2-5 Others cautions

- Do not wipe the equipment with organic solvent, such as alcohol or benzene, etc. Use a neutral cleaning agent for cleaning it.
- Do not use mobile phones near the equipment (within 50cm). Otherwise the malfunction may result.
- The use of the equipment near radios, TVs, or wireless devices may cause malfunctions.
- After turning the power ON, it needs 5 to 15 sec. until it starts communication.
- Prior to wiring / connecting the equipment, always take a countermeasure against static electricity (ESD).

# Part names and functions

## - Main unit

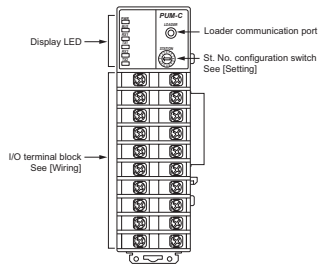

### Display LED

Six LED lamps indicate the following operation conditions.

LED Name	GREEN	RED	ORANGE
PWR	Blinking (0.4-sec. periods): No communication with any modules. (Inter-module communication FAULT)	ON: No communication with PLC (Inter-PLC communication FAULT) (*Note 1)	-
	Blinking (0.1-sec. periods): Executing initial polling	Blinking (0.4-sec. period): System FAULT	
	ON: Normal operation		
BUS	ON: The inter-module communications being received	-	ON: Inter-module communications being sent
RX1	ON: RS-232C being received	-	-
TX1	-	-	ON: RS-232C / RS-422 being sent
RX2	RS422 being received	-	-
TX2	-	-	-

\*Note1 The cause of system FAULT: EEPROM FAULT, rotary SW FAULT, Dip SW FAULT.

## - The base part

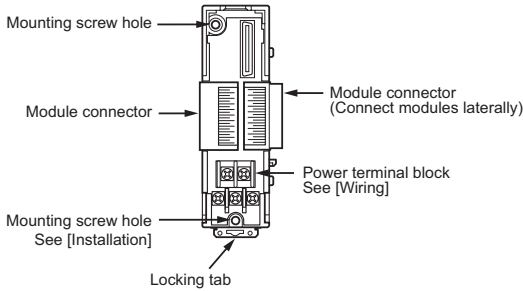

## - Communication behavior setting

Set communication behavior by DIP switches on the back front of the module (SW1 to SW6).

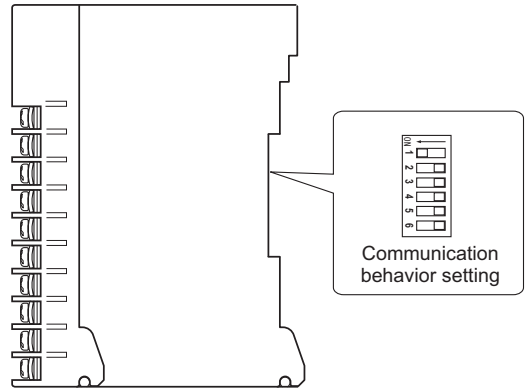

SW No.	Functions	
	ON	OFF
1	RS-422 communication mode	RS-232C communication mode
2	No function	
3	No function	
4	No function	
5	No function	
6	When turning the power ON, reset the inter-PLC communication setting to the factory-set value.	No function

# Setting

## - Station Numbers Setting

The station number configuration switch must be set to "0".  
(Communications with PLC is not possible with any setting other than "0".)

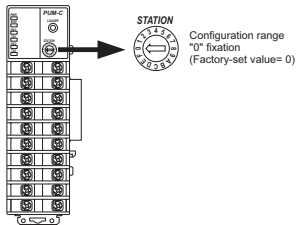

# Mounting

## - Dimensions

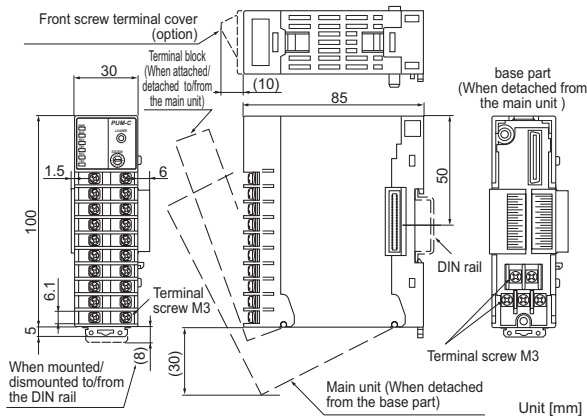

## - Cautions when mounting

Make sure to secure clearance space more than 30mm (50mm is recommended) above/below the equipment for.

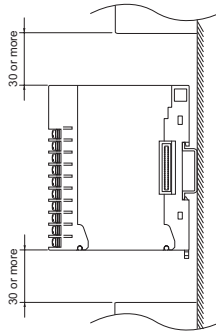

## - Mounting to DIN rails

1. Pull down the locking tab of the base part. Hook the back part of the unit onto the upper part of the DIN rails.
2. Push the unit towards the direction of the arrow 2.

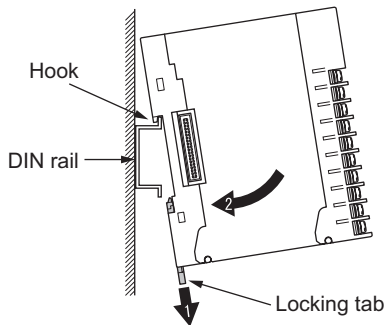

3. Pull up the locking tab of the base part to fasten the equipment onto the DIN rails.

- When connecting the equipment after mounting it to the DIN rail, do not pull the locking tab up at this point yet.

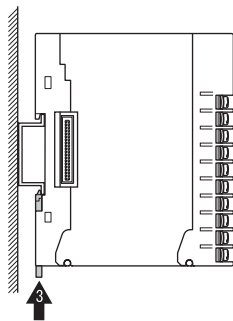

## - Attaching the endplates

When mounting the equipment onto the DIN rails more firmly, use endplates (optional). (When using endplates, use side connecting terminal covers as well.)

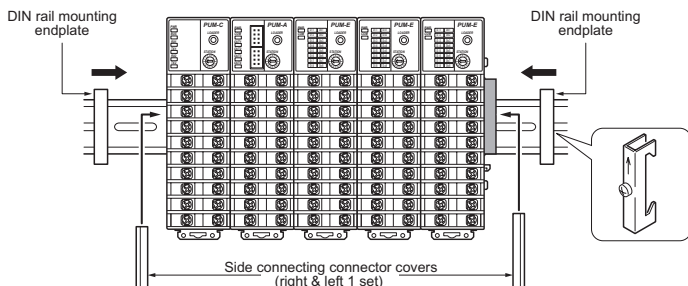

## - Fixing with screws

When fixing the equipment on the wall with using screw, connect module base parts first, which are intended to mount.

1. Decide the mounting position, referring to the figure below for the mounting screw hole.

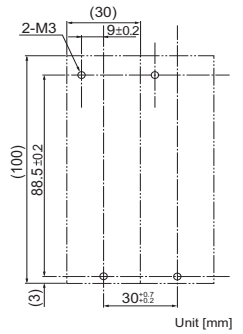

2. Remove the main unit from the base part.  
- See [How to detach the base part]
3. Connect the base part, and then pull all the locking tabs up to fasten.
4. Fixate the base part onto the mounting position on the wall with screws.
5. Attach the module main unit to the base part.

## - Connecting modules

1. Check the locking tab is pulled down.
2. Connect modules by connecting module connectors with each other.

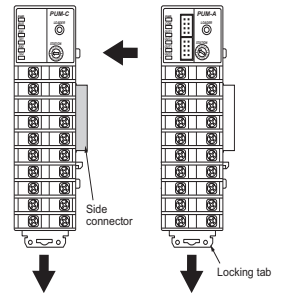

3. After mounting modules to the DIN rails, pull the all locking tabs up. Modules are fastened to the DIN rails and to each other on the same time.
4. The power supplies are connected each other inside connected modules.

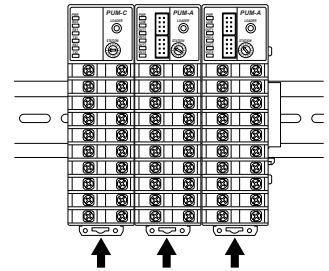

## How to detach the base part

1. Press the lock lever on the top of the equipment.
2. Pulling down the upper part of main unit.
3. Detach the cutout on the lower end of the back of the main unit from the projection on the base part.

- Attaching the main unit to the base part take the reverse procedure to removing the main unit from the base part.  
- Make sure the locking lever on the main unit is fitted into the base part after attaching.

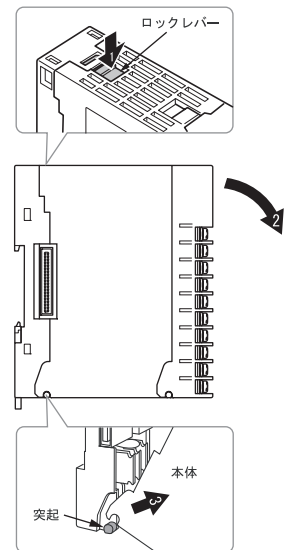

# Terminal Figure

## - Front face terminal block

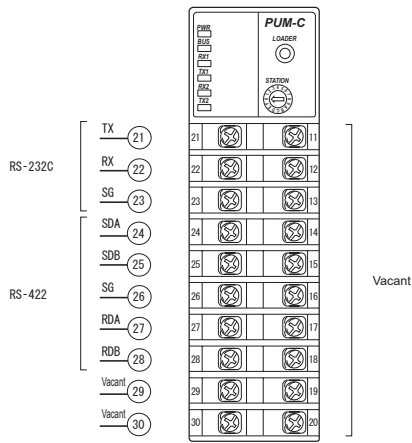

## - Base part (power terminal)

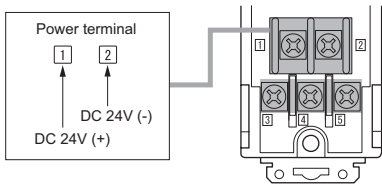

Note: Power cables more than one should not be connected between power terminals.

# Wiring

## - Connecting to PLC

### In the case of RS-232C connection

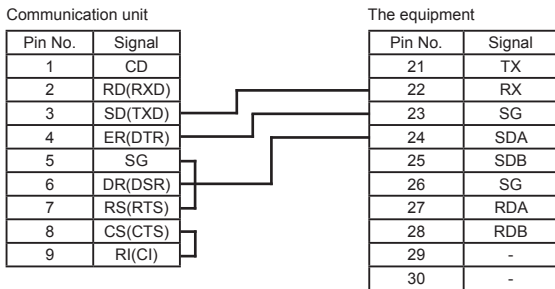

### In the case of RS-422 connection

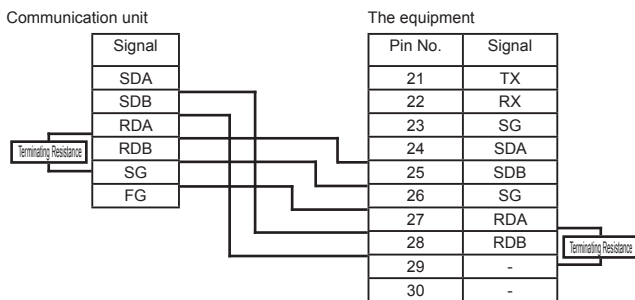

Terminating resistance: 330Ω

\*Both connection of RS-232C and RS-422 of the equipment can not operate at the same time.

# Specification

## General Specification

Power Supply	: DC24V±10%
Power Consumption	: Maximum 3.2W (135mA) [when 24Vdc is applied]
Dimensions	: 30(W)×100(H)×85(D) mm (excluding projection and terminal cover)
Weight	: Approx. 200g
Installation Method	: DIN rail mounting inside a cabinet / wall mounting with M3 screws
Ambient Temperature*	: -10 to 50 degrees C
Note: "Ambient temperature" mean the temperature underneath the equipment inside the device or the cabinet where it is installed.	
Ambient Humidity:	: 90%RH or less (no condensing)
System maximum modules:	: Up to max. 17 modules of any Model PUMA/B/C/CL/CMV/NT plus to max 16 modules of Model PUME
System power	: 24V dc, 100W maximum, Class 2
Memory Backup:	: Backup by nonvolatile memory (EEPROM) The number of rewriting: 100,000 times

## Connectable device

Connectable serial communication units in compliance with MELSEC-Q series

Type	Communication port	
	CH1	CH2
QJ71C24N QJ71C24	RS232C (D-sub 9P)	RS422 (2-piece terminal block)
QJ71C24N-R2 QJ71C24-R2	RS232C (D-sub 9P)	RS232C (D-sub 9P)
QJ71C24N-R4	RS422 (2-piece plug-in connector socket block)	RS422 (2-piece plug-in connector socket block)

## Communication Functions

Communication specifications	: RS-232C and RS-422-compliance
The number of port	: 1 port (specifying RS-232C / RS-422 by switch)
Communication protocol	: MC protocol Type5
Communication speed	: 9.6k, 19.2k, 38.4k, 57.6k, 115.2k, 230.4kbps
Communication length	: RS232C: Max. 15m RS422: Max. 1km (38.4kbps or less), 500m (57.6kbps or less), 250m (115.2kbps or more)
Recommended cable: RS232C cable	: KFPEV-SB 1P 0.5sq (equivalent to Fuji electric cable)
RS422 cable:	: KFPEV-SB 2P 0.5sq (equivalent to Fuji electric cable)
Connecting method	: M3 screw terminal block

## Crimp terminal size

Please prepare cables and crimp terminals of the size indicated below.

When using a AWG-16 cable, you should use the crimp terminal that material thickness is 0.9mm or less.

Cable type	Size
Power supply, output, others	0.25 to 1.25mm <sup>2</sup> (AWG 22 to 16)

## Crimp terminal

Cable size	Screw tightening torque
0.25 to 1.25mm <sup>2</sup> (AWG 22 to 16)	0.8 N·m

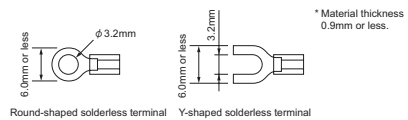

# Model code

## Enhanced communication module (Mitsubishi's PLC programless communication)

1	2	3	4	5	6	7	8	9	10	Contents	
P	U	M								Enhanced communication module	
											Mitsubishi's PLC programless communication
											Japanese
										English	

## Model code (Optional)

1	2	3	4	5	6	7	8	Contents	
P	U	M	Z	*				DIN rail mounting endplate	
									Side connector termination cover (right & left 1 set)
									Loader connecting cable (RS232C)

# Fuji Electric Co., Ltd.

## International Sales Div Sales Group

Gate City Ohsaki, East Tower, 11-2, Osaki 1-chome,  
Shinagawa-ku, Tokyo 141-0032, Japan  
http://www.fujielectric.com  
Phone: 81-3-5435-7280, 7281 Fax: 81-3-5435-7425  
http://www.fujielectric.com/products/instruments/