



Micro controller X



Type: PXZ

OPERATION MANUAL

Contents

1. Operating Parts and Functions	1
2. Operation	2
2-1 Parameter Table	2
2-2 Basic operation	4
2-3 Parameter functions and setting method	5
Setting of set value (SV)	5
Setting of proportional band	6
Integral time	7
Derivative time	8
Lower limit alarm (ALM2) setting (option)	9
Upper limit alarm (ALM1) setting (option)	10
Setting of proportional cycle of control output 1	11
2-position action hysteresis width	12
Heater burnout alarm (option)	13
Auto-tuning	15
Cooling side cycle of control output 2	16
Cooling side proportional band coefficient	17
Shift of cooling side proportional band	18
Output 1 lower limit setting	19
Output 1 upper limit setting	19
Output 2 lower limit setting	19
Output 2 upper limit setting	19
Setting of operation mode of output limiter	20
Output convergence value, Anti-reset wind up	21
Key lock	22
Program status display	23
Setting of ramp/soak control (ProG) (option)	24
Setting of control mode	25
Input filter constant	26
Setting of input type	27
Alarm hysteresis width (option)	28
Lower limit of measurement range and set value (SV)	29
Upper limit of measurement range and set value (SV)	29
Setting of lower limit alarm (ALM2) action type (option)	30
Setting of upper limit alarm (ALM1) action type (option)	30
Setting of RCJ compensation	32
Setting of decimal point position	33
PV offset	34
SV offset	35
Selection of measurement input °C/°F	36
FUZY control setting	37
User's adjust zero adjustment, User's adjust span adjustment	38
Skipping of parameter display	39
3. Troubleshooting	40

Operating Parts and Functions

Fig. 1-1 shows the outline of the front panel of the unit.

On the front of the unit, there are PV/SV digital indication lamps, condition indication lamps and setting keys. Table 1-1 shows the functions of these operating parts. Before using the unit, be sure to understand the functions of the operating parts.

For details of setting parameters, refer to Chapter 2 of this manual.

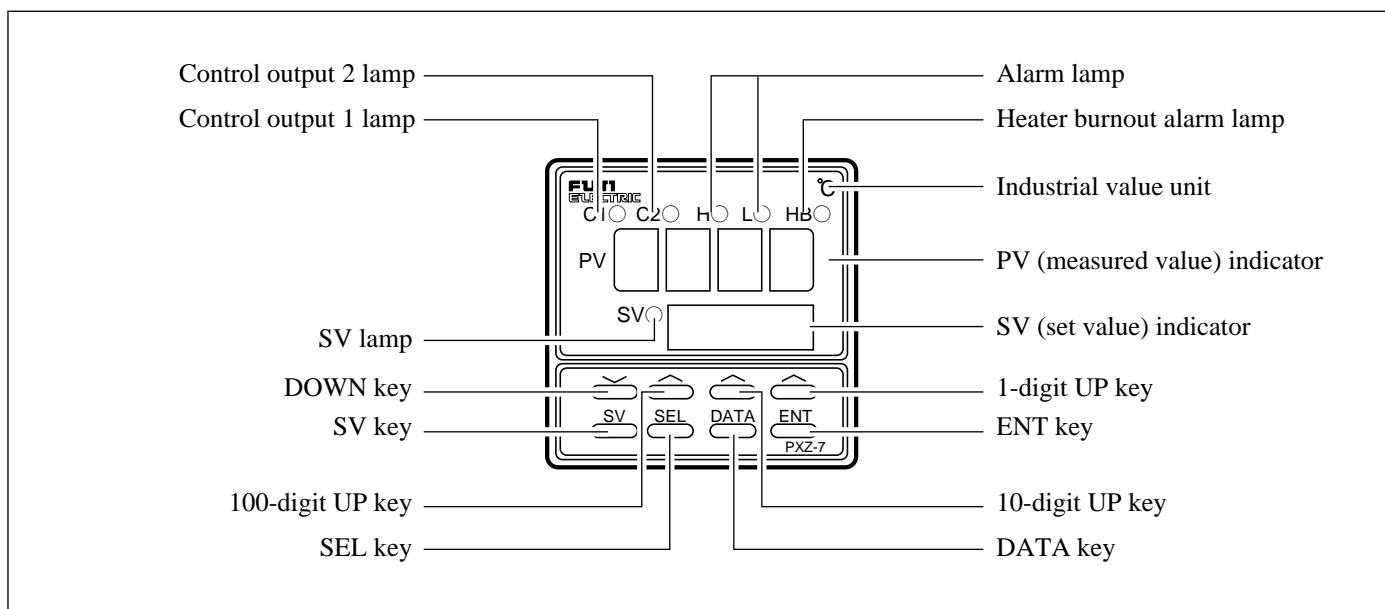

Fig. 1-1

Table 1-1

Name	Function
Control output 1 lamp	Lights at ON of control output 1.
Control output 2 lamp	Lights at ON of control output 2.
Alarm lamp	Lights at alarm detection. Alarm output is ON at the same time.
Heater burnout alarm lamp	Lights at detection of heater burnout. Heater burnout alarm output is ON at the same time.
PV (measured value) indicator	Indicates measured values.
SV (set value) indicator	Indicates set values. Also indicates parameters and data at setting of parameters.
1-digit “ \wedge ” key (1-digit key)	1-digit data value increases at change of SV or at data setting.
10-digit “ \wedge ” key (10-digit key)	10-digit data value increases at change of SV or at data setting.
100-digit “ \wedge ” key (100-digit key)	100-digit data value increases at change of SV or at data setting.
“ \vee ” key	Value of flickering digit decreases at change of SV or data setting.
“ SV ” key	48 x 48mm size: Used to select SV/PV display. Other size: Returns to set value (SV) display from parameter display.
“ SEL ” key	Used to select parameter block or parameter.
“ DATA ” key	Used to display parameter value.
“ ENT ” key	Used to enter parameter value.

The setting of set values (SV) and internal parameters of the Micro Controller X are explained in the following.

2-1 Parameter Table

On Micro Controller X, parameters are classified into No. 1 and No. 2 blocks according to operation frequency. No. 1 and No. 2 blocks are used for initial setting and whenever necessary.

① No. 1 block parameter table

Parameter display symbol	Name	Description	Initial set value prior to delivery	User's set value	Parameter mask DSP	Page
<i>ProG</i>	ProG	Lamp soak control oFF: Stop rUn: Start HLd: Pause	Lamp soak start/stop	oFF	1-1	24
<i>P</i>	P	Proportional band	Setting range; 0.0 to 999.9% (for input range)	5.0	1-2	6
<i>I</i>	I	Integral time	Setting range; 0 to 3200 sec.	240	1-4	7
<i>d</i>	D	Derivative time	Control stability is enhanced with input change. It reacts quickly with change of small deviation at large derivative time (D). (Setting range: 0.0 to 999.9 sec.)	60.0	1-8	8
<i>AL</i>	L	Lower limit alarm	Used to set lower limit operation of alarm. Setting within input range is possible (option).	10	1-16	9
<i>AH</i>	H	Upper limit alarm	Used to set upper limit operation of alarm. Setting within input range is possible (option).	10	1-32	10
<i>TC</i>	TC	Control output 1 proportional cycle	Used to set control output proportional cycles. (Setting range: 1 to 150 sec.)	Contact output: 30 SSR/SSC drive output 2	1-64	11
<i>HYS</i>	HYS	2-position action hysteresis width	Used to set hysteresis width at 2-position action. (Setting range: 0.0 to 50.0%FS)	1	1-128	12
<i>Hb</i>	HB	Heater burnout alarm	Used to set value of heater burnout detection (option). (Setting range: 1.0 to 50.0A) [Alarm function OFF at 0]	0.0	2-1	13
<i>AT</i>	AT	Auto-tuning	Used to set PID parameters by auto-tuning. 0: None (auto-tuning released or not executed) 1: Execution (standard type; auto-tuning is executed by SV value) 2: Execution (low PV type; auto-tuning is executed at -10FS of SV value)	0	2-2	15
<i>TC2</i>	TC2	Control output 2 proportional cycle	Used to set proportional cycle of cooling side control output (option). (Setting range: 1 to 150 sec.)	Contact output: 30 SSR/SSC drive output 2	2-4	16
<i>Cool</i>	Cool	Cooling side proportional band coefficient	Used to set cooling side proportional band coefficient (option). (Setting range: 0.0 to 100.0) The setting of 0 will lead to ON-OFF operation.	1.0	2-8	17
<i>db</i>	db	Cooling side proportional band shift	Used to shift cooling side output value (option). (Setting range: -50.0 to +50.0)	0.0	2-16	18
<i>PLC1</i>	PLC1	Output 1 lower limit setting	Setting range: -3.0 to 103.0%	-3.0	2-32	19
<i>PHC1</i>	PHC1	Output 1 higher limit setting	Setting range: -3.0 to 103.0%	103.0	2-64	19
<i>PCuT</i>	PCuT		Peculiar parameter for device. Do not use.	—	2-128	20
<i>BAL</i>	BAL	Output convergence value	Function to suppress overshoot.	Single: 0.0 Dual : 50.0	3-1	21
<i>Ar</i>	AR	Antireset wind up	Used to suppress overshoot due to integral action. (Setting range: 0 to 100%FS)	100%FS	3-2	21
<i>LoC</i>	LoC	Key lock	Designates enable or disable to change the parameter setting. 0: Change of all parameter setting is possible. 1: Change of all parameter setting is not possible. 2: Change of set value (SV) only is possible.	0	3-4	22
<i>STAT</i>	STAT	Ramp/soak present position display	Used to display present ramp/soak position (option).	OFF	3-8	23
<i>SV-1</i> } <i>SV-4</i>	SV-1 } <i>SV-4</i>	No.1 to No.4 target value	Used to set ramp/soak target value (option). (setting range: 0 to 100%FS)	0%FS	3-16 3-128 4-4 4-32	23
<i>TM1r</i> } <i>TM4r</i>	TM1r } <i>TM4r</i>	No.1 to No.4 ramp segment time	Used to set time for segment of ramp (option). (setting range: 0 to 99h59m)	0.0	3-32 4-1 4-8 4-64	23
<i>TM1S</i> } <i>TM4S</i>	TM1S } <i>TM4S</i>	No.1 to No.4 soak segment time	Used to set time for segment of soak (option). (setting range: 0 to 99h59m)	0.0	3-64 4-2 4-16 4-128	23
<i>Mod</i>	Mod	Ramp/soak function mode setting	Setting of oupt at power ON start and end, at power OFF, and setting of repeat action (option).	0	5-1	23

No. 2 block parameters are used for setting the initial set values, and for special operation and setting.

② No. 2 block parameter table

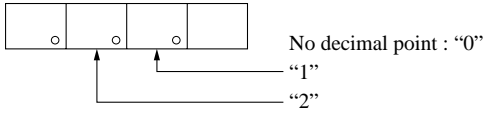
Parameter display symbol	Name	Description	Initial set value prior to delivery	User's set value	Parameter mask DSP	Page
<i>P-n1</i>	P-n1	Setting of control method	Setting of normal/reverse action of set output and burnout direction.	As per ordering specification	5-4	25
<i>P-n2</i>	P-n2	Setting of input type	Setting of input type	As per ordering specification	5-8	27
<i>P-dF</i>	P-dF	Input filter parameter	Setting of input filter parameter (second) (Setting range: 0.0 to 900.0 sec.)	5.0	5-16	26
<i>P-SL</i>	P-SL	Setting of lower limit range	Setting of lower limit input range	As per ordering specification	5-32	29
<i>P-SU</i>	P-SU	Setting of higher limit range	Setting of higher limit input range	As per ordering specification	5-64	29
<i>P-AL</i>	P-AL	Setting of lower limit alarm (ALM2) type	Setting of alarm action type	9	5-128	30
<i>P-AH</i>	P-AH	Setting of higher limit alarm (ALM1) type	Setting of alarm action type	5	6-1	30
<i>P-An</i>	P-An	Setting of alarm hysteresis	Setting of alarm output ON-OFF hysteresis width (Setting range: 0 to 50%FS)	1	6-2	28
<i>rCJ</i>	RCJ	RCJ compensation setting	on: RCJ compensation ON (cold contact compensation is performed) off: RCJ compensation OFF (cold contact compensation is not performed)	on	6-8	32
<i>P-dP</i>	P-dP	Setting of decimal point position	Selects decimal point position of PV/SV display. 	As per ordering specification	6-4	33
<i>PVOF</i>	PVOF	PV offset	Shift of input value (PV) display. (Setting range: -10 to 10%FS)	0	6-16	34
<i>SVOF</i>	SVOF	SV offset	Shift of set value (SV) display. SV display remains unchanged. (Setting range: -50 to 50%FS)	0	6-32	35
<i>P-F</i>	P-F	Selection of unit °C/°F of measured value input	Measured value is selected, so other parameters need to be changed. °C display: C °F display: F	As per ordering specification	6-64	36
<i>PLC2</i>	PLC2	Output 2 lower limit setting	Setting range: -3.0 to 103.0%	-3.0	6-128	19
<i>PHC2</i>	PHC2	Output 2 higher limit setting	Setting range: -3.0 to 103.0%	103.0	7-1	19
<i>FUZY</i>	FUZY	FUZY control setting	ON: FUZY control is performed. OFF: Normal PID control is performed.	OFF	7-2	37
<i>ADJO</i>	ADJO	User adjust zero adjustment	Used for shifting input zero side by user adjust function.	0	7-8	38
<i>ADJS</i>	ADJS	User adjust span adjustment	Used for shifting input span side by user adjust function.	0	7-16	38
<i>OUT</i>	OUT	Output value (MV) display	display of present output value (MV)	—	7-32	—
<i>dSP1</i> } <i>dSP7</i>	dSP1 } dSP7	Parameter skip	Setting of parameter display "yes or no"	Setting is made according to code symbol	—	39

Items shown in are not displayed. If necessary, they are able to be displayed and set by using the dsp1 to dsp7 function of No.2 block parameter.

2-2 Basic operation

① Condition at power ON

Operation	Description	Display	
Power ON	Display at power ON is shown at right.	PXZ4	PV <input type="text"/> <input type="text"/> <input type="text"/> <input type="text"/> SV <input type="text"/> <input type="text"/> <input type="text"/> <input type="text"/>
		PXZ5/7/9	PV <input type="text"/> <input type="text"/> <input type="text"/> <input type="text"/> SV <input type="text"/> <input type="text"/> <input type="text"/> <input type="text"/>

② Selection of parameter

Basic operation of PXZ is shown below. When PXZ4 (1 stage display type) is used, PV/SV is displayed on the one stage display. In this case, PV/SV display is selected by pressing [SEL] and [PV/SV] keys.

If the unit is not operated for 30 seconds, the display is set to PV/SV display just after power ON.

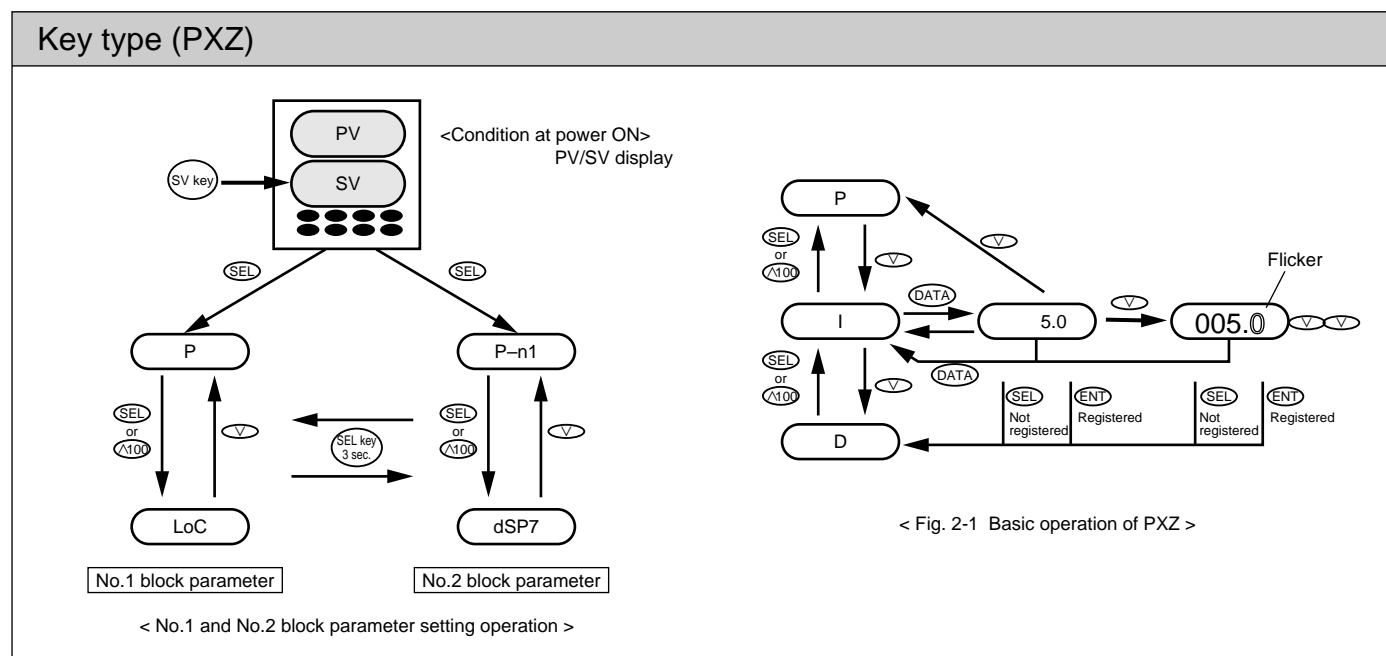

③ Setting of numerical value

⬆ key : Numerical value increases by 1 at each press of key.

It keeps increasing by pressing continuously.

⬇ key : Numerical value decreases by 1 at each press of key.

It keeps decreasing by pressing continuously.

④ Registration of set data

Automatically registered 3 seconds after data is set.

2-3 Parameter functions and setting method

Setting of set value (SV)

[Description]

- Set values are control target values.
- Upper/lower limit of set value is designated by No. 2 block parameter P-SU/P-SL. P-SL (lower limit) or P-SU (upper limit) cannot be used for setting outside the range (See page 29).
- When a temperature sensor is used for input, the unit of set value is °C or °F. Selection between °C and °F is made by No. 2 block parameter P-F.

Related parameter: P-SL (Page 29)
 P-SU (Page 29)
 LOC (Page 22)

Example) Altering SV 250°C to 1195°C

Key operation	Description	Display				
SEL	Press the SEL key to display P.	<table border="1" style="display: inline-table; border-collapse: collapse;"> <tr> <td style="width: 20px; height: 20px;"></td> <td style="width: 20px; height: 20px;"></td> <td style="width: 20px; height: 20px;"></td> <td style="width: 20px; height: 20px; text-align: center;">P</td> </tr> </table>				P
			P			
DATA	Press DATA key once, then SV display lamp is lighted, and current value is displayed.	<table border="1" style="display: inline-table; border-collapse: collapse;"> <tr> <td style="width: 20px; height: 20px;"></td> <td style="width: 20px; height: 20px; text-align: center;">2</td> <td style="width: 20px; height: 20px; text-align: center;">5</td> <td style="width: 20px; height: 20px; text-align: center;">0</td> </tr> </table> <small>PV</small> <small>SV</small>		2	5	0
	2	5	0			
<div style="display: flex; justify-content: space-around;"> ^ v </div>	Press the (^) or (v) key to display 1195.	<table border="1" style="display: inline-table; border-collapse: collapse;"> <tr> <td style="width: 20px; height: 20px; text-align: center;">1</td> <td style="width: 20px; height: 20px; text-align: center;">1</td> <td style="width: 20px; height: 20px; text-align: center;">9</td> <td style="width: 20px; height: 20px; text-align: center;">5</td> </tr> </table>	1	1	9	5
1	1	9	5			
ENT	SV is automatically registered in 3 seconds.	<table border="1" style="display: inline-table; border-collapse: collapse;"> <tr> <td style="width: 20px; height: 20px; text-align: center;">1</td> <td style="width: 20px; height: 20px; text-align: center;">1</td> <td style="width: 20px; height: 20px; text-align: center;">9</td> <td style="width: 20px; height: 20px; text-align: center;">5</td> </tr> </table>	1	1	9	5
1	1	9	5			
SV	Press the SV key to return to the operating status display. Also, after 30 seconds without key operation, data is automatically returned to the operating status display.	<table border="1" style="display: inline-table; border-collapse: collapse;"> <tr> <td style="width: 20px; height: 20px; text-align: center;">1</td> <td style="width: 20px; height: 20px; text-align: center;">1</td> <td style="width: 20px; height: 20px; text-align: center;">9</td> <td style="width: 20px; height: 20px; text-align: center;">5</td> </tr> </table>	1	1	9	5
1	1	9	5			



Setting of proportional band (Setting range: 0 to 999.9% for input range)

[Description]

- Proportional band can be set automatically by auto-tuning.
- Manual setting is also possible. If P value is too small, control action becomes unstable, and if it is too large, the response becomes slow.
- When P is set to 0.0, 2-position action becomes effective.
The hysteresis under 2-position action should be set with the parameter HYS.
- When dual output type is used and it is set to P = 0.0 and COOL = 0.0, the heating and cooling outputs are as shown in the following diagram. In this case, the hysteresis is fixed at 0.5%.

Example) Altering proportional band 10.0% to 15.0%

Key operation	Description	Display
SEL	Press the SEL key to display P.	□ □ □ P
↓		
DATA	Press the DATA key once. Current proportional band (10.0%) is displayed.	□ 10.0
↓		
△ ▽	Press the △ or ▽ key to display 15.0.	□ 15.0
↓		
ENT	Press the ENT key, then proportional band is registered. Operation is started with 15.0% proportional band.	□ □ □ □
↓		
SV	Hold down the key for 3 seconds to display the operation status.	1 1 9 5

Related parameter: HYS (Page 12)

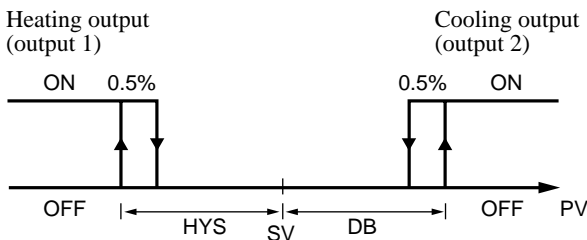



Integral time (Setting range: 0 to 3200 sec.)

[Description]

- Integral time can be set automatically by auto-tuning.
- Manual setting is also possible.
- When I value is set to 0, integral action becomes OFF and P action or PD action is effected.

Example) Altering the integrating time of 600 seconds to 840 seconds

Key operation	Description	Display
SEL	Press the SEL key to display P.	
SEL	Press the SEL key once.	
DATA	Press the DATA key once. Current integrating time (600 seconds) is displayed.	
^ v	Press the (^) or (v) key to display 840.	
ENT	Press the ENT key, then the integrating time is registered. Operation is started with an integrating time of 840 seconds.	
SV	Press the SV key, when you need display the operation status.	



Derivative time (Setting range: 0.0 to 999.9 seconds)

[Description]

- Derivative time can be set automatically by auto-tuning.
- Manual setting is also possible.
- When D value is set to 0, derivative action becomes OFF and P action or PI action is effected.

Example) Altering a derivative time of 120.0 seconds to 100.0 seconds

Key operation	Description	Display
SEL	Press the SEL key to display P.	□ □ □ P
SEL	Press the SEL key repeatedly until d' is displayed.	□ □ □ d'
DATA	Press the DATA key once. Current derivative time (120.0 seconds) is displayed.	1 2 0 . 0
^ v	Press the (^) or (v) key to display 100.0.	1 0 0 . 0
ENT	Press the ENT key, then the derivative time is registered. Operation is started with 100.0 seconds of derivative time.	
SV	Press the SV key when you need to display the operation status.	1 1 9 5

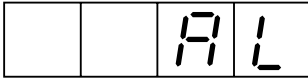

Lower limit alarm (ALM2) setting (option) (Setting is possible within input range)

[Description]

- Alarm is not displayed without lower limit alarm function.
- When input or deviation is smaller than AL, or when deviation is larger than AL, alarm output turns ON.
- When using lower limit alarm, it is necessary to set alarm type (see parameter P-AL) and appropriate code.
- When lower limit alarm with hold function is used, lower limit alarm does not turn ON even if the input is smaller than AL (see diagram (c) below).
- When it is the range alarm and input or deviation is smaller than AL, the alarm output turns OFF (see diagram (b) below).
- Selection between absolute value alarm and deviation alarm is made by P-AL.
- Alarm action hysteresis can be set by No. 2 block parameter P-An.

Related parameter: P-AH (Page 30)
P-AL (Page 30)
P-An (Page 28)

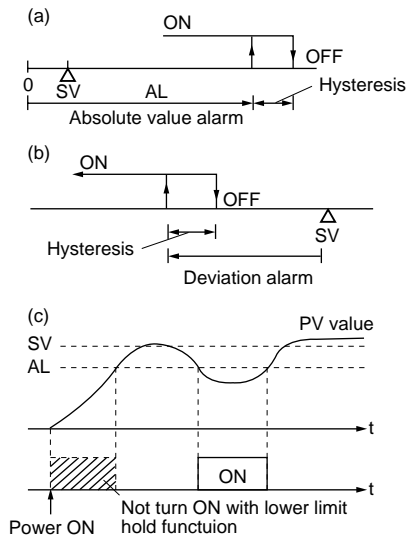

Example) Altering the lower limit alarm of 200°C to 100°C

Key operation	Description	Display
(SEL)	Press the SEL key to display P.	
(SEL)	Press the SEL key repeatedly until AL is displayed.	
(DATA)	Press the DATA key once. Current lower limit alarm value (200°C) is displayed.	
(^) (v)	Press the (^) or (v) key to display 100.	
(ENT)	Press the ENT key, then the lower limit alarm value is registered. Operation is started with 100°C of lower limit alarm.	
(SV)	Press the SV key when you need to display the operation status display.	

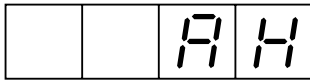

Upper limit alarm (ALM1) setting (option) (Setting is possible within input range)

[Description]

- Alarm is not displayed without upper limit alarm function.
- When using upper limit alarm, it is necessary to set alarm type (see parameter P-AH) and appropriate code.
- When input or deviation is larger than AH, the alarm output turns ON (see diagram (a) below).
- When it is the range alarm and input or deviation is larger than AH, the alarm output turns ON (see diagram (b) below).
- Selection between absolute value alarm and deviation alarm is made by P-An.
- Alarm action hysteresis can be set by No. 2 block parameter P-An.

Related parameter: P-AH (Page 30)
P-AL (Page 30)
P-An (Page 28)

Example) Altering the upper limit alarm of 300°C to 550°C

Key operation	Description	Display
(SEL)	Press the SEL key to display P.	
(SEL)	Press the SEL key repeatedly until AH is displayed.	
(DATA)	Press the DATA key once. Current upper limit alarm value (300°C) is displayed.	
(^) (v)	Press the (^) or (v) key to display 550.	
(ENT)	Press the ENT key, then the upper limit alarm value is registered. Operation is started with 550°C of lower limit alarm.	
(SV)	Press the SV key when you need to display the operation status display.	

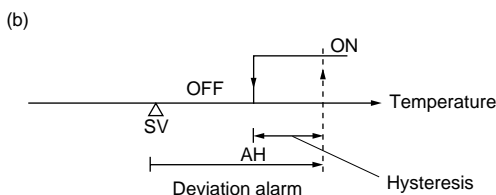
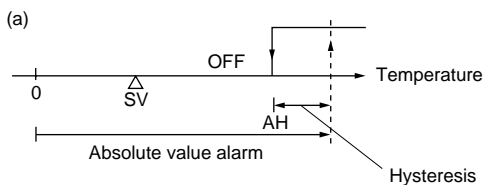

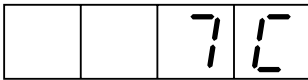

Setting of proportional cycle of control output 1 (Setting range 1 to 150 sec.)

[Description]

- When contact output or SSR drive output type is used, the output turns ON/OFF at a contact cycle when the input is within the proportional band.

This cycle is called the proportional cycle. The output value is expressed by the ratio which the output turns ON within the time of proportional cycle.

As the time of proportional cycle becomes short, control can be made more accurately, but it reduces the life of operation terminal unit, so it needs to be set in consideration of the life of operation terminal unit.

In this case of current output, this parameter is not displayed.

The following shows the standard proportional cycles.

SSR, SSC :

Proportional cycle, 1 to 2 sec.

Contact output :

Proportional cycle, 20 to 30 sec.

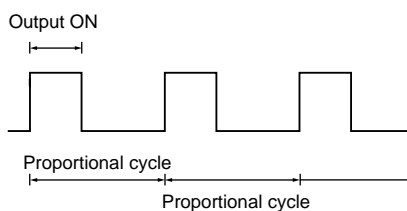

Example) Altering a proportional cycle of 30 seconds to 20 seconds

Key operation	Description	Display
SEL	Press the SEL key to display P.	
SEL	Press the SEL key repeatedly until 70 is displayed.	
DATA	Press the DATA key once. Current proportional cycle (30 seconds) is displayed.	
^ / v	Press the (^) or (v) key to display 20.	
ENT	After press the ENT key, the proportional cycle is registered. Operation is started with 20 seconds of proportional cycle.	
SV	Press the SV key when you need to display the operation status display.	

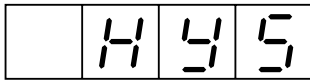

2-position action hysteresis width (Setting range: 0.0 to 50.0%FS)

[Description]

- Hysteresis width under the 2-position action control can be set as shown in the example. When hysteresis width is set small, the control efficiency is improved, but the number of operations increases and decreases the life of the operation terminal unit and the device.
- Hysteresis width is necessary to prevent chattering due to noise.
- For 2-position action, the value of P (proportional band) should be set to 0.0.
- Set value can be obtained by industrial value.

Related parameter: P (Page 6)

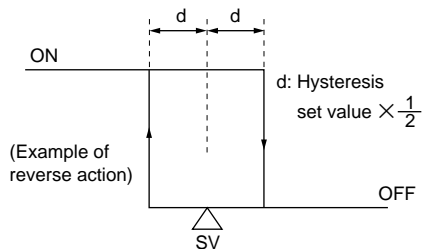

Example) Altering the hysteresis width of 1°C to 2°C

Key operation	Description	Display
SEL	Press the SEL key to display P.	
SEL	Press the SEL key repeatedly until <i>H45</i> is displayed.	
DATA	Press the DATA key once. Current data of 1°C is displayed.	
^ v	Press the (^) or (v) key to display 2.	
ENT	After press the ENT key, data of 2°C is registred. Operation is started with 2°C of data.	
SV	Press the SV key when you need to display the operation status display.	

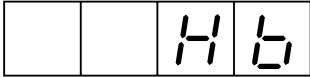

Heater burnout alarm (option) (Setting range: 1.0 to 50.0A)

[Description]

- Burnout detect current (parameter Hb) should be set according to the type of heater being used.
It is set to 0.0 prior to delivery from the factory.
- Alarm operating point is set by parameter Hb.
- Current detector (CT) comes in 2 types, 0 to 30A type (CTL-6-SF) and 20 to 50A type (CTL-12-S36-8F). It should be selected according to the heater power source being used.
- Setting of alarm operating point
 - Apply current to the heater with the controller output turned ON.
 - Search alarm operating value while changing the set value of Hb (when changing the set value, the next set value should be changed more than 3 seconds later).
 - After operating point is obtained, use 70 to 80% of the value as the final set value.
 - When N number of heaters are used, set it in the middle between the current at N number of heaters and that of N-1 number.

- The heater burnout alarm function can not be used in case when the heater is controlled by thyristor phase angle control system.
- When 3-phase heater is used, heater burnout can be detected in some cases. For details, contact our office.
- Connect of heater burnout detect CT

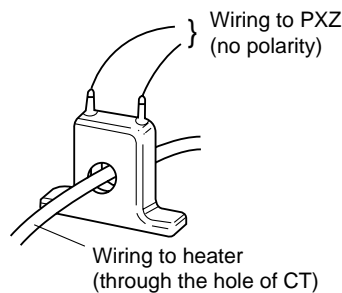

- When detection error is large due to small heater capacity, increase the apparent current 2 times larger by putting the wire twice through the hole to improve the sensitivity of the detector (in this case, set the current to a two-fold value).
- When wire through CT is wound many turns, be sure to wind it from the same direction.

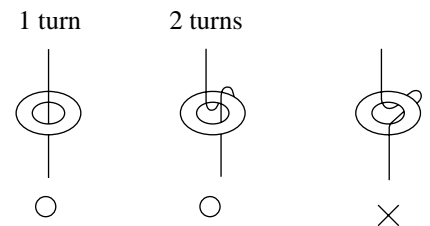

(Note) In using heater burnout alarm, set the proportional cycle (TC) to more than 20 seconds.

- Example of connection of heater burnout alarm (Type: PXZ5, PXZ9)

Related parameter: TC (Page 11)

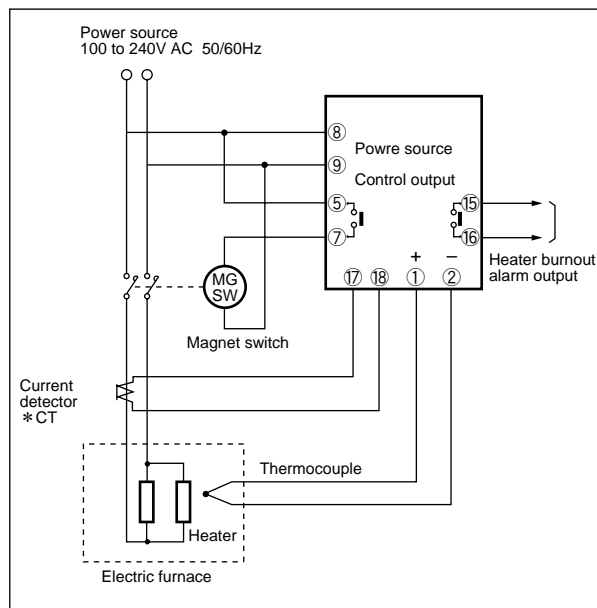

Example) Altering alarm setpoint of heater burnout current of 9.0A to 8.0A

Key operation	Description	Display
SEL	Press the SEL key to display P.	<input type="text" value=""/> <input type="text" value=""/> <input type="text" value=""/> <input type="text" value="P"/>
SEL	Press the SEL key repeatedly until Hb is displayed.	<input type="text" value=""/> <input type="text" value=""/> <input type="text" value="H"/> <input type="text" value="b"/>
DATA	Press the DATA key once. Current data of 9.0A is displayed.	<input type="text" value=""/> <input type="text" value=""/> <input type="text" value="9"/> <input type="text" value="."/> <input type="text" value="0"/>
▲ ▼	Press the ▲ or ▼ key to display 8.0.	<input type="text" value=""/> <input type="text" value=""/> <input type="text" value="8"/> <input type="text" value="."/> <input type="text" value="0"/>
ENT	After pressing the ENT key, data of 8.0A is registred. Operation is started with data of 8.0A.	
SV	Press the SV key when you need to display the operation status display.	<input type="text" value="1"/> <input type="text" value="1"/> <input type="text" value="9"/> <input type="text" value="5"/>

□ □ **A 7**

Auto-tuning (Setting range: 0, 1, 2)

[Description]

- PID value can be set automatically.
- Once PID value is set automatically by auto-tuning, it is saved in the controller even when the power is turned OFF, so auto-tuning function is not required any further.
- Auto-tuning is started by setting 1 or 2 in AT parameter. AT value is automatically reset to 0 at the end of auto-tuning.
- At the end of auto-tuning, control action is started automatically by setting PID.
- During auto-tuning, the decimal point at 1 digit of SV display flickers.
- When auto-tuning is forcibly suspended, set AT value to 0 or turn OFF the instrument power.
- AT is available in the following 2 types.

Setting code	Method
1	SV type SV ON-OFF action
2	Low PV type SV-10%FS ON-OFF action

[During auto-tuning, ON-OFF control is performed which causes overshoot for SV. But, the overshoot can be eliminated by low PV type auto-tuning.]

- Auto-tuning is available just after the start of operation or in the stare of stable control.

Example) Starting auto-tuning

Key operation	Description	Display
SEL	Press the SEL key to display P.	□ □ □ P
SEL	Press the SEL key repeatedly until A 7 is displayed.	□ □ A 7
DATA	Press the DATA key once. Current data of 0 is displayed.	□ □ □ 0
^ v	Press the (^) or (v) key to display 1.	□ □ □ 1
ENT	After pressing the ENT key, auto-tuning is started automatically.	□ □ □ 1
SV	Press the SV key when you need to display the operation status display.	1 1 9 5
(In auto-tuning)	Decimal point in 1st digit blinks. [In case of the type of 2-stage display, decimal point in the 1st digit of the lower stage blinks.]	1 1 9 5
(Auto-tuning ends)	When auto-tuning is finished, decimal point in the 1st digit stops blinking.	1 1 9 5

Blinking disappears.

Related parameter: P (Page 6)
I (Page 7)
D (Page 8)
CooL (Page 17)
Ar (Page 21)

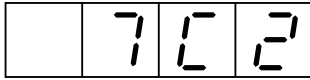

Cooling side proportional cycle of control output 2 (DUAL type only) (Setting range: 1 to 150 sec.)

[Description]

- This setting is required only for DUAL type.
- When contact output or SSR drive output type is used, the output turns ON/OFF at a constant cycle when the input is within the proportional band.
This cycle is called the proportional cycle.
The output value is expressed by the ratio of which the output turns ON within the time of proportional cycle.
As the time of proportional cycle becomes short, control can be made more accurately, but it reduces the life of operation terminal unit, so it needs to be set in consideration of the life of operation terminal unit.
- In the case of current output, this parameter is not displayed.

Example) Altering cooling control proportional cycle of 30 seconds to 20 seconds

Key operation	Description	Display
(SEL)	Press the SEL key to display P.	
(SEL)	Press the SEL key repeatedly until 702 is displayed.	
(SEL)	Press the DATA key once. Current data (30 seconds) is displayed.	
(^) (v)	Press the (^) or (v) key to display 20.	
(ENT)	After pressing the ENT key, the proportional cycle value of the control output 2 is registered. Operation is started with 20 seconds of cycle.	
(SV)	Press the SV key when you need to display the operation status display.	

The following shows the standard proportional cycles.

SSR, SSC :

Proportional cycle, 1 to 2 sec.

Contact output :

Proportional cycle, 20 to 30 sec.

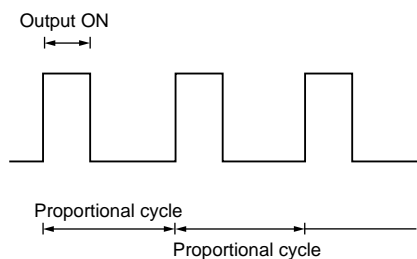

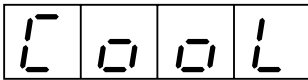

Cooling side proportional band coefficient (DUAL type only) (Setting range: 0, 0.1 to 100.0)

[Description]

- Cooling side proportional band coefficient can be set automatically by auto-tuning.
- Cooling side proportional band can be set (see diagram (a) below).
- To set cooling side proportional band, its coefficient should be obtained to optimum control from the following equation after setting heating side proportional band.
 - Heating side proportional band is $\frac{\text{Proportional band (P)}}{2}$.
 - Set the coefficient to 0, and the cooling side is put in ON-OFF action.

$$\text{Cooling side proportional band} = \frac{\text{Proportional band (P)}}{2} \times \text{Coefficient}$$

Example) Set cooling side proportional band to 10% of full scale by proportional band (P) = 50%.

$$10\% = \frac{50\%}{2} \times \text{Coefficient}$$

Therefore, Coefficient = 0.4

(a)

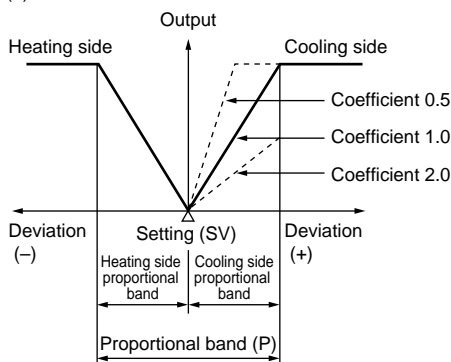

Example) Altering cooling control proportional band coefficient of 5.0 to 5.5

Key operation	Description	Display
SEL	Press the SEL key to display P.	
SEL	Press the SEL key repeatedly until is displayed.	
DATA	Press the DATA key once. Current data (5.0 coefficient) is displayed.	
▲ ▼	Press the ▲ or ▼ key to display 5.5.	
ENT	After pressing the ENT key, the cooling side proportional band coefficient is registered. Operation will be started with 5.5 coefficient.	
SV	Press the SV key when you need to display the operation status display.	

Related parameter: P (Page 6)

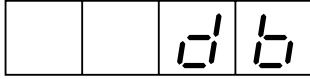

Shift of cooling side proportional band (dead band/overlap band) (DUAL type only) (Setting range: -50.0 to +50.0%)

[Description]

- Cooling side proportional band can be shifted for set value (SV) (see diagram (a) below).
- When the value of db is positive, it is called the dead band, and when the value is negative, it is called the overlap band.
- The value of db is set in MV (%). When it is set in deviation (%), it can be converted from the following equation and set.

$$DB (\%) = \text{Deviation} \times \frac{100}{P} (\%)$$

Example) When proportional band (P) = 5.0% and dead band for SV is set at deviation 1.0 (%), the following equation is used for setting this parameter to 20%.

$$DB (\%) = 1.0 \times \frac{100}{5.0} = 20 (\%)$$

Example) Altering dead band/overlap band of 0% to 1.0% (dead band)

Key operation	Description	Display
SEL	Press the SEL key to display P.	
SEL	Press the SEL key repeatedly until is displayed.	
DATA	Press the DATA key once. Current data (0%) is displayed.	
^ / v	Press the ^ or v key to display 1.0.	
ENT	After pressing the ENT key, the shift value of the cooling side proportional band is registered. Operation will be started with 1.0%.	
SV	Press the SV key when you need to display the operation status display.	

Related parameter: P (Page 6)

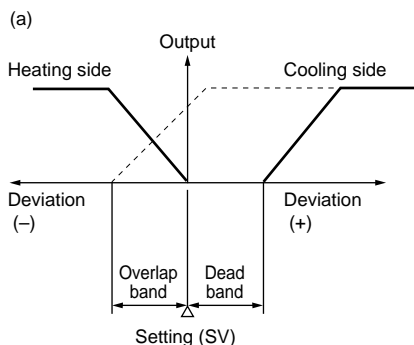

PLC1

Output 1 lower limit setting (Setting range: -3.0 to 103.0%)

PHC1

Output 1 upper limit setting (Setting range: -3.0 to 103.0%)

PLC2

Output 2 lower limit setting (Setting range: -3.0 to 103.0%)

PHC2

Output 2 upper limit setting (Setting range: -3.0 to 103.0%)

(No display prior to delivery)

[Description]

- These setting is not required unless necessary especially.
- These are used when the output is contact output or SSR/SSC drive output.
- Output pulse width (ON time) is set not to lower below the set value (PLC1, PLC2).
Also, output pulse width (ON time) is set not to raise above the set value (PHC1, PHC2). (This determines the minimum value of output OFF time).
- This function prevents flashing when combustion is controlled by ON/OFF of gas supply.

$$PLC1 = \frac{100}{TC} \times (\text{Minimum ON pulse width [sec.]})$$

$$PHC1 = 100 - \frac{100}{TC} \times (\text{Minimum OFF pulse width [sec.]})$$

$$PLC2 = \frac{100}{TC2} \times (\text{Minimum ON pulse width [sec.]})$$

$$PHC2 = 100 - \frac{100}{TC2} \times (\text{Minimum OFF pulse width [sec.]})$$

TC : Proportional cycle

TC2 : Control output 2 proportional cycle

Related parameter: TC (Page 11)
TC2 (Page 16)

Example) Altering lower limit pulse width limiter from 20% to 10%

Key operation	Description	Display
SEL	Press the SEL key to display P.	P
SEL	Press the SEL key repeatedly until PLC1 is displayed.	PLC1
DATA	Press the DATA key once. Current lower limit pulse width limiter (20) is displayed.	20
^ v	Press the (^) or (v) key to display 10.	10
ENT	After pressing the ENT key, the lower limit pulse width limiter is registered.	
SV	Press the SV key when you need to display the operation status display.	1195

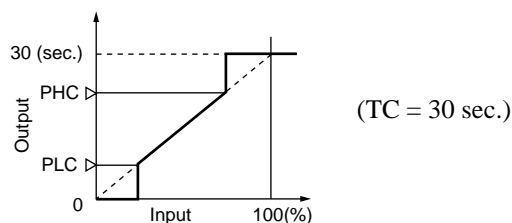

PCUT

Setting of operation mode of output limiter (Setting range: 0 to 1.5)

[Description]

- This function is used to set the operation mode of the output (1 or 2) limiter.
- Normally, this parameter need not be changed.
- When the output value is set to the limit set value, it is possible to set whether the output is limited by that value or it is scaled out.

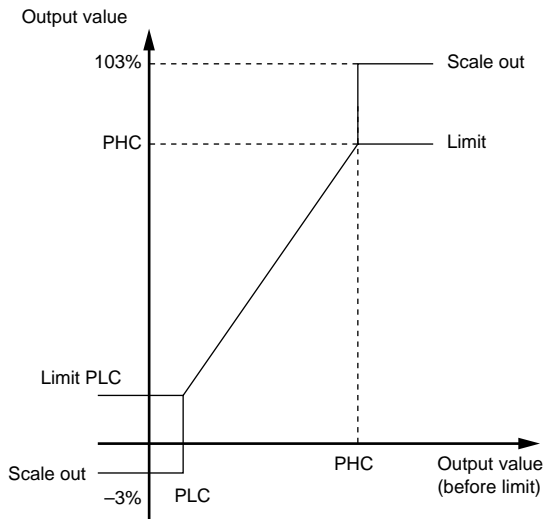

Example) Set the lower/upper limit of output 1 and output 2 to limit action

Key operation	Description	Display
(SEL)	Press the SEL key for 3 seconds, and P-n1 is displayed.	P-n1
(SEL)	Press the SEL key to display PCUT.	PCUT
(DATA)	Press the DATA key to display current data.	0
(^) (v)	Press the (^) or (v) key to display 15.	15
(ENT)	After pressing the ENT key, the data is registered.	
(SV)	Press the SV key when you need to display the operation status display.	1195

PCUT	Output 1		Output 2	
	Upper limit	Lower limit	Upper limit	Lower limit
0	103%	-3%	103%	-3%
1	103%	Limit	103%	-3%
2	Limit	-3%	103%	-3%
3	Limit	Limit	103%	-3%
4	103%	-3%	103%	Limit
5	103%	Limit	103%	Limit
6	Limit	-3%	103%	Limit
7	Limit	Limit	103%	Limit
8	103%	-3%	Limit	-3%
9	103%	Limit	Limit	-3%
10	Limit	-3%	Limit	-3%
11	Limit	Limit	Limit	-3%
12	103%	-3%	Limit	Limit
13	103%	Limit	Limit	Limit
14	Limit	-3%	Limit	Limit
15	Limit	Limit	Limit	Limit

BAL

Output convergence value (Setting range: -100.0 to 100.0%)

Ar

**Anti-reset wind up (Setting range: 0 to 100%FS)
(No display prior to delivery)**

[Description]

- This setting is not require unless it is necessary.

This function is used to suppress over-shoot.

- Anti-reset wind up (Ar) is automatically set in optimum value by P.I.D auto-tuning.

The value of over-shoot can be controlled by setting BAL.

- By setting anti-reset wind up (Ar) in optimum value, unwanted integral action can be cut and over-shoot is reduces.

(Note) This controller has fuzzy control function, so over-shoot can be minimized without using BAL and Ar. This parameter is used only for interchangeability with former type (PYZ series).

Example) Altering anti-reset wind up of 80°C to 60°C

Key operation	Description	Display
SEL	Press the SEL key to display P.	□□□P
SEL	Press the SEL key repeatedly until Ar is displayed.	□□Ar
DATA	Press the DATA key once. Current data (80°C) of anti-reset wind up is displayed.	□□80
^ v	Press the (^) or (v) key to display 60.	□□60
ENT	After pressing the ENT key, anti-reset wind up data is registred.	
SV	Press the SV key when you need to display the operation status display.	1195

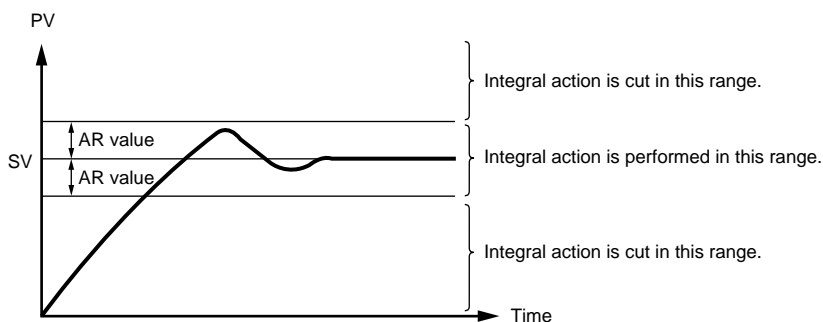

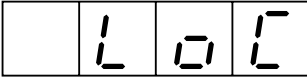

Key lock (Setting range: 0, 1, 2)

[Description]

- Key lock is a function not to change set data accidentally. Parameters SV and data can be displayed.

- When key lock is released again, change the setting to release the key to "0".

(Note) Key lock comes in 2 types, one is used to prevent change of all setting (setting = 1) and another is used to prevent change of values other than SV (setting = 2).

Setting code 0: No lock

Setting code 1: Lock of all settings

Setting code 2: Lock of values other than SV

Example) Key lock to prevent accidental data change

Key operation	Description	Display
SEL	Press the SEL key to display P.	P
↓ SEL	Press the SEL key repeatedly until L o L is displayed.	L o L
↓ DATA	Press the DATA key once. Current data 0 is displayed.	0
↓ ^ v	Press the (^) or (v) key to display 1.	1
↓ ENT	After pressing the ENT key, key-locked data is registred. Operation will be started with lock of all settings.	
↓ SV	Press the SV key when you need to display the operation status display.	1 9 5

STAT

Program status display (display only)

SV-1

SV-4

No. 1 to 4 target value

TM1r

TM4r

No. 1 to 4 ramp time

TM1s

TM4s

No. 1 to 4 soak time

[Description]

- This is a function to change set value (SV) with time automatically according to preset pattern. Up to 4 ramp/soak data can be programmed.
- No. 1 ramp starts from measurement value (PV) just before the program is executed.
- It is also possible to run the program automatically at power ON (power ON start function).

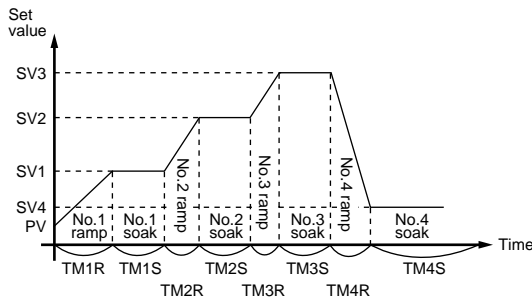

Ramp.... Time to change in set value toward target value.

Soak Time not to change set value as it is set to target value.

[Parameters]

To execute this function, the program should be set in advance. It can be set by setting the required set value (SV) in the parameters shown in the table at right.

Related parameter: ProG (Page 24)

Example) Set No. 1 target value to 400°C

Key operation	Description	Display
SEL	Press the SEL key to display P.	□□□P
SEL	Press the SEL key repeatedly until SV-1 is displayed.	SV-1
DATA	Press the DATA key to display data.	□□□0
▲ ▼	Press the ▲ or ▼ key to display 400°C.	400
ENT	After pressing the ENT key, the data is registered.	□□□□
SV	Press the SV key when you need to display the operation status display.	1195

Parameter display symbol	Name	Description	Initial value at delivery	Remarks
STAT	Actual program position	The state of program execution is displayed. This parameter is used only for display and cannot be used for setting.	—	Not displayed when ramp/soak is not given.
□FF	Stop			
1-rP-4-rP	No.1 to 4 ramp under execution			
1-S-4-S	No.1 to 4 soak under execution			
END	Program end			
SV-1 SV-4	No.1 to 4 ramp target value	Target value (SV) of each ramp time can be set. (Setting range: 0 to 100%FS)	0	
TM1r TM4r	No.1 to 4 ramp time	Each ramp time can be set. (Setting range: 0 to 99 hour and 59 minute)	0.00	
TM1s TM4s	No.1 to 4 soak time		0.00	
Mod	Ramp SV mode	Used for selection of mode of ramp/soak function. Normally it is set to "0".	0	

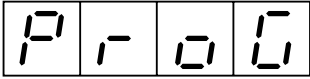

Setting of ramp/soak control (ProG) (option)

[Description]

- This function is used to change time and set value (SV) automatically according to preset pattern. Up to 4 ramp/soak programs can be used.
- The No. 1 ramp starts from measurement value (PV) just before the execution of program.
- It is also possible to run the program automatically at power ON (power ON start function).

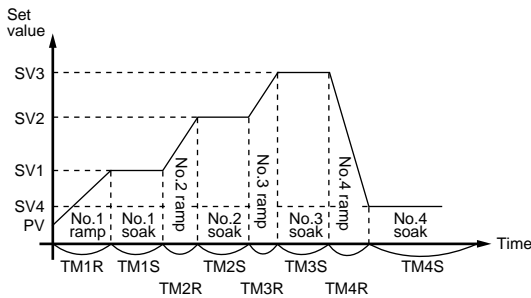

Example) Start ramp/soak operation (rUn) from local operation (oFF)

Key operation	Description	Display
(SEL)	Press the SEL key to display ProG.	Pr o G
(DATA)	Press the DATA key. Current data (o F F) is displayed.	o F F
(^) (v)	Press the (^) or (v) key to display r U n.	r U n
(ENT)	After pressing the ENT key, setting data of ramp/soak control is registered. Start operation according to preset ramp/soak patterns.	
(SEL)	Press the SEL key when you need to display the operation status display.	1 1 9 1

Ramp Range of change in set value toward target value

Soak Range of unchanged set value, the same as target value

Related parameter: STAT (Page 23)
SV-1 ~ SV-4 (Page 23)
TM1r ~ TM4r (Page 23)
TM1s ~ TM4s (Page 23)

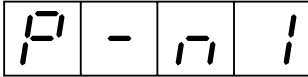

Setting of control mode

[Description]

- Used to set control mode, normal/reverse action and the direction of burnout.
- Control mode is classified into the standard type (1 output) and the dual output type for heating/cooling control.
- The main body of standard type is different from that of dual output type. Be sure to set a code that conforms to the main unit.

Example) Altering lower burnout/reverse action to upper burnout/normal action

Key operation	Description	Display
SEL	Press the SEL key for 3 seconds, and P-n1 is displayed.	P - n 1
DATA	Press the DATA key to display data.	□ □ □ 0
^ v	Press the ^ or v key to display 3.	□ □ □ 3
ENT	After pressing the ENT key, upper burnout/normal action is registered.	
SV	Press the SV key when you need to display the operation status display.	1 1 9 5

Control action code table

Code (P-n1)	Output type	Control action		Direction of burnout	
		Output 1	Output 2	Output 1	Output 2
0	Single	Reverse action	...	Lower limit	...
1				Upper limit	
2		Normal action		Lower limit	
3				Upper limit	
4	Dual	Reverse action	Normal action	Lower limit	Lower limit
5				Upper limit	
6				Lower limit	Upper limit
7					
8		Normal action	Normal action	Lower limit	Lower limit
9				Upper limit	
10				Lower limit	Upper limit
11					
12		Reverse action	Reverse action	Lower limit	Lower limit
13				Upper limit	
14				Lower limit	Upper limit
15					
16	Normal action	Reverse action	Lower limit	Lower limit	
17			Upper limit		
18			Lower limit	Upper limit	
19					Upper limit

P - d F

Input filter constant (Setting range: 0.0 to 900.0 sec.)

[Description]

- Input filter function is used to reduce noise contained in input signal. Input filter constant is time constant.

For example, the following response can be obtained by setting the input filter constant to 10 seconds.

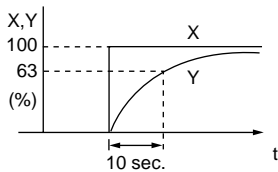
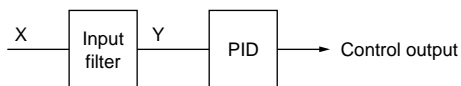

- The set value is the time to read 63% (Y) on the controller for change in PV of 100% (X).

(Note) The unit is set to 5.0 (5 sec.) prior to delivery. Do not change it unless necessary.

Example) Altering filter constant 5.0 (5 seconds) to 10.0 (10 seconds)

Key operation	Description	Display
SEL	Press the SEL key for 3 seconds, and P-n1 is displayed.	P - n 1
SEL	Press the SEL key repeatedly until P-dF is displayed.	P - d F
DATA	Press the DATA key. Current data is displayed.	5.0
▲ ▼	Press the ▲ or ▼ key to display 10.0.	10.0
ENT	After pressing the ENT key, the data is registered.	
SV	Press the SV key when you need to display the operation status display.	1195

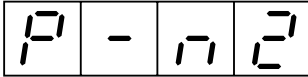

Setting of input type

[Description]

- Input type can be set.
- The main unit is determined according to input type (2 types shown below). Set a code that conforms with the main unit.
- Input type can be changed within the same types. It cannot be changed to different types.

Type I : Thermocouple (9 types),
Resistance bulb (1 type)

Type II : Voltage, current

- On the Type II, when selecting voltage input or current input, it becomes necessary to change the code and connect an resistor 250Ω to the input terminal when current input is used.
- When changing the voltage input, remove the resistor 250Ω from the input terminal.

Change of software

After changing software, turn OFF the power and then turn ON once again.

- Input type and code

① Input type code table

Type	Code (P-n2)
Resistance bulb	1
• Pt100	
Thermocouple	2
• J	
• K	
• R	
• B	
• S	
• T	
• E	
• N	
• PL-II	13
1 to 5V DC, 4 to 20mA DC	16

Example) Altering thermocouple from K to T on Type I

Key operation	Description	Display
SEL	Press the SEL key for 3 seconds, and P-n1 is displayed.	P - n 1
SEL	Press the SEL key repeatedly until P-n2 is displayed.	P - n 2
DATA	"3" is displayed, and it is clear thermocouple K is selected.	3
▲ ▼	Press the ▲ or ▼ key to display 7.	7
ENT	After pressing the ENT key, the data is registered.	
SEL	Press the SEL key for 3 seconds when you need to display the operation status display.	1 1 9 5

Related parameter: P-SL (Page 29)
P-SU (Page 29)
P-dP (Page 33)

P - A n

Alarm hysteresis width (option) (Setting range: 0 to 50%FS)

[Description]

- Alarm is 2-position action, ON and OFF, while hysteresis is the difference in input ON and OFF. For example, when hysteresis is 5°C, the width of ON and OFF is 5°C.

Normally, it is set to 1°C

- Decimal point is given automatically by setting it with P-dP.

(Upper limit alarm)

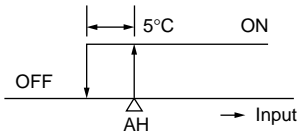

(Lower limit alarm)

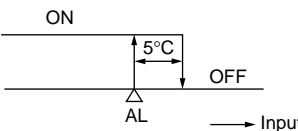

(Range alarm)

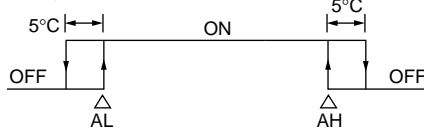

Example) Altering alarm hysteresis 1°C to 3°C

Key operation	Description	Display
SEL	Press the SEL key for 3 seconds, and P-n1 is displayed.	P - n 1
SEL	Press the SEL key repeatedly until P-An is displayed.	P - A n
DATA	Press the DATA key. Current data is displayed.	□ □ □ 1
^ v	Press the (^) or (v) key to display 3.	□ □ □ 3
ENT	After pressing the ENT key, the data is registered.	
SV	Press the SV key when you need to display the operation status display.	1 1 9 5

- Related parameter: AL (Page 9)
 AH (Page 10)
 P-AH (Page 30)
 P-AL (Page 30)

P - 5 L

Lower limit of measurement range and set value (SV)
(Setting range: -1999 to 9999)

P - 5 U

Upper limit of measurement range and set value (SV)
(Setting range: -1999 to 9999)

[Description]

- Lower limit (minimum range) and upper limit (maximum range) of measurement ranges can be set. This setting is used as a limiter of set value (SV). Change of set value (SV) to others outside of the lower/upper limit range is not possible.
- When 1 digit below the decimal point needs to be displayed, it should be set to 1 by P-dP.
- When P-n2 is set to 0 to 13 (temperature input), up to 1 digit (P-dP parameter = 1) below the decimal point becomes effective.
- For the input range, refer to the following table.

Related parameter: P-dP (Page 33)

② Input range table (standard range)

		Measurement range (°C)	Measurement range (°F)	With decimal point (°C)	With decimal point (°F)
Resistance bulb JIS (IEC)	Pt100Ω	0 to 150	32 to 302	○	○
	Pt100Ω	0 to 300	32 to 572	○	○
	Pt100Ω	0 to 500	32 to 932	○	○
	Pt100Ω	0 to 600	32 to 1112	○	×
	Pt100Ω	-50 to 100	-58 to 212	○	○
	Pt100Ω	-100 to 200	-148 to 392	○	○
	Pt100Ω	-150 to 600	-238 to 1112	○	×
	Pt100Ω	-150 to 850	-238 to 1562	×	×
Thermocouple	J	0 to 400	32 to 752	○	○
	J	0 to 800	32 to 1472	○	×
	K	0 to 400	32 to 752	○	○
	K	0 to 800	32 to 1472	○	×
	K	0 to 1200	32 to 2192	×	×
	R	0 to 1600	32 to 2912	×	×
	B	0 to 1800	32 to 3272	×	×
	S	0 to 1600	32 to 2912	×	×
	T	-199 to 200	-328 to 392	○	×
	T	-150 to 400	-238 to 752	○	×
	E	0 to 800	32 to 1472	○	×
	E	-199 to 800	-328 to 1472	○	×
PL-II	0 to 1300	32 to 2372	×	×	
Direct current voltage	1 to 5V DC	-1999 to 1999 (Scaling possible)			

Example) Altering the measuring range of 0 ~ 150°C to -100 ~ 200°C (Pt100)

Key operation	Description	Display
SEL	Press the SEL key for 3 seconds, and P-n1 is displayed.	P - n 1
SEL	Press the SEL key repeatedly until P-SL is displayed.	P - 5 L
DATA	Current measuring range is displayed.	0
^ v	Press the (^) or (v) key to display -100.	- 100
ENT	After pressing the ENT key, the data is registered.	P - 5 U
DATA	Press the DATA key. Current measuring range is displayed.	150
^ v	Press the (^) or (v) key to display 200.	200
ENT	After pressing the ENT key, the data is registered.	
SV	Press the SV key when you need to display the operation status display.	195

* For 4 to 20mA DC input, connect external resistor 250Ω and use as 1 to 5V DC input.

Note) Input accuracy is ±0.5%FS±1digit with the exception of the following.

- R thermocouple, 0 to 400°C : ±1%FS±1digit±1°C
- B thermocouple, 0 to 500°C : ±5%FS±1digit±1°C
- Other thermocouples : ±0.5%FS±1digit±1°C

P - AL

Setting of lower limit alarm (ALM2) action type (option)

P - AH

Setting of upper limit alarm (ALM1) action type (option)

[Description]

- Alarm action can be selected from 16 types. Of these types, deviation alarm, absolute value alarm, range alarm and hold (lower limit) are explained in the following. Alarm is specified by either one of deviation and absolute value.

Deviation alarm

When alarm is outputted at temperature of more than 100°C above 100°C of set value (SV) and more than 50°C below the set value, the setting of upper limit alarm (AH) is 100°C and that of lower limit alarm (AL) is 50°C. When the set value (SV) changes, the alarm action point is also changed.

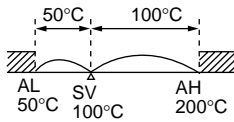

Absolute value alarm

When alarm is outputted at temperature of more than 200°C and less than 50°C, the setting of upper limit alarm (AH) is 200°C and that of lower limit alarm (AL) is 50°C. Unlike the deviation alarm, the alarm action point remains unchanged at change of the set value.

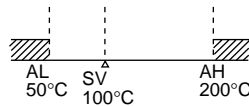

Range alarm

In the case of range alarm, either one of absolute value and deviation can be selected. Alarm is outputted between AL and AH.

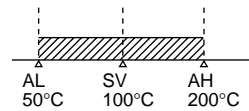

Lower limit hold

At the start of operation, the furnace temperature is normally below 100°C. In this case, lower limit alarm is not outputted. When temperature rises above the set value of AL and then lowers, lower limit alarm turns ON. This function is called the alarm action "Hold".

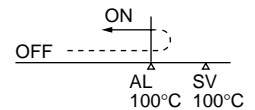

Related parameter: AL (Page 9)
AH (Page 10)
P-An (Page 28)

Alarm action type code table

	ALM1 (P-AH)	ALM2 (P-AL)	Alarm type	Action diagram		ALM1 (P-AH)	ALM2 (P-AL)	Alarm type	Action diagram
	0	0	Without alarm			11	11	Range upper/lower limit deviation (ALM1/2 independent action)	
Absolute value alarm	1	1	Upper limit absolute		Range alarm	—	12	Range upper/lower limit absolute	
	2	2	Lower limit absolute			—	13	Range upper/lower limit deviation	
	3	3	Upper limit absolute (with hold)			—	14	Range upper limit absolute and lower limit deviation	
	4	4	Lower limit absolute (with hold)			—	15	Range upper limit deviation and lower limit absolute	
Deviation alarm	5	5	Upper limit deviation			Note) Alarm set value may change with change in alarm action type.			
	6	6	Lower limit deviation						
	7	7	Upper/lower limit deviation						
	8	8	Upper limit deviation (with hold)						
	9	9	Lower limit deviation (with hold)						
	10	10	Upper/lower limit deviation (with hold)						

Example) Altering upper limit alarm (ALM1) action from upper limit deviation alarm to upper limit absolute value alarm

Key operation	Description	Display
SEL	Press the SEL key for 3 seconds, and P-n1 is displayed.	P - n 1
SEL	Press the SEL key repeatedly until P-AH is displayed.	P - A H
DATA	Press the DATA key. Data is displayed. Display 5 due to deviation alarm. Check that 5 is displayed and change the alarm to absolute value alarm 1.	□ □ □ 5
^ v	Press the (^) or (v) key to display 1.	□ □ □ 1
ENT	After pressing the ENT key, the data is registered.	
SV	Press the SV key when you need to display the operation status display.	1 1 9 5

Upper limit alarm (ALM1) and lower limit alarm (ALM2) are the same key operation with the exception of range alarm action. Upper limit alarm (ALM1) can be used low-low limit alarm by setting is as lower limit alarm or lower limit alarm (ALM2) as upper-upper alarm by setting is as upper limit alarm.

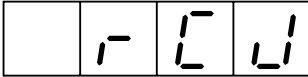

Setting of RCJ compensation

[Description]

- This function is used whether or not RCJ compensation (cold contact compensation) is used for thermocouple input. Normally, it should be used at ON (RCJ compensation) which has been set prior to delivery from the factory.
- It should be set to OFF only when cold contact compensation is not required, for example, when cold contact compensation is to be made with external circuit or temperature deviation needs to be obtained.

Example) Altering cold junction compensation from ON to OFF

Key operation	Description	Display
SEL	Press the SEL key for 3 seconds, and P-n1 is displayed.	P-n1
SEL	Press the SEL key repeatedly until RCJ is displayed.	rL U
DATA	Current data is displayed.	on
^ v	Press the (^) or (v) key to display OFF.	off
ENT	After pressing the ENT key, the data is registered.	
SV	Press the SV key when you need to display the operation status display.	1195

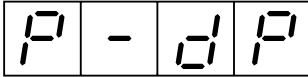

Setting of decimal point position (Setting range: 0 to 2)

[Description]

- Decimal point position can be set on LED display.

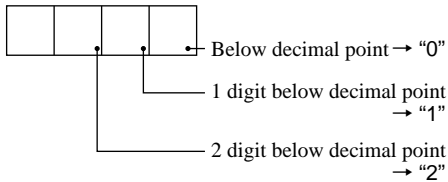

Related parameter: P-SL (Page 29)
P-SU (Page 29)

Example) Altering the measuring range 0 ~ 150°C to 0.0 ~ 150°C

Key operation	Description	Display
SEL	Press the SEL key for 3 seconds, and P-n1 is displayed.	P - n 1
SEL	Press the SEL key repeatedly until P-dP is displayed.	P - d P
DATA	"0" is displayed and it is clear that none below decimal point is set.	0
^ / v	Press the (^) or (v) key to display 1.	1
ENT	After pressing the ENT key, the data is registered.	
SV	Press the SV key when you need to display the operation status display.	1195

P U O F

PV offset (Setting range: -10 to 10%FS)

[Description]

- Set value is added to designated input value. It is mainly used when recorder needs to conform with the designated value.
- Control is performed by the displayed PV value (PV offset is added).

Example) Set the zero shift width of 5°C to input value 1200°C

Key operation	Description	Display
SEL	Press the SEL key for 3 seconds, and P-n1 is displayed.	P - n 1
SEL	Press the SEL key repeatedly until PVOF is displayed.	P U O F
DATA	Press the DATA key. Data is displayed.	□ □ □ 0
^ v	Press the (^) or (v) key to display 5.	□ □ □ 5
ENT	After pressing the ENT key, the data is registered.	
SV	Press the SV key when you need to display the operation status display.	1 1 9 5

S U O F

SV offset (Setting range: -50 to 50%FS)

[Description]

- The value set in SV offset is added to original SV to perform control by SV value. It is mainly used to eliminate offset during P control. In this case, designated SV value remains unchanged.
- Control is performed by the display SV value (SV offset is added).

Example) Set the zero shift width of 9°C to current setting value.

Key operation	Description	Display
SEL	Press the SEL key for 3 seconds, and P-n1 is displayed.	P - n 1
SEL	Press the SEL key repeatedly until SVOF is displayed.	S U O F
DATA	Press the DATA key. Data is displayed.	□ □ □ 0
^ v	Press the (^) or (v) key to display 9.	□ □ □ 9
ENT	After pressing the ENT key, the data is registered.	
SV	Press the SV key when you need to display the operation status display.	1 1 9 5

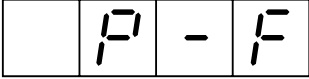

Selection of measurement input °C/°F

[Description]

- The unit (°C or °F) of temperature can be selected for temperature input. It has been set according to the ordering specifications prior to delivery from factory. If it becomes necessary to change it after purchase, the input range (P-SL, P-SU), alarm value (AL, AH), set value (SV) and offset (PVOF, SVOF) should be changed.

The unit of temperature is shown on the front nameplate. It should also be changed at the same time.

(Note 1)

$$T_1 (°F) = \frac{9}{5} T_2 (°C) + 32$$

Related parameter: SV (Page 5)
 P-SL (Page 29)
 P-SU (Page 29)
 AL (Page 9)
 AH (Page 10)

Example) Altering the unit of measurement input from °C to °F

Key operation	Description	Display
SEL	Press the SEL key for 3 seconds, and P-n1 is displayed.	P - n 1
SEL	Press the SEL key repeatedly until P-F is displayed.	P - F
DATA	Press the DATA key. Data is displayed.	0 C
^ / v	Press the (^) or (v) key to display °F.	0 F
ENT	After pressing the ENT key, the data is registered.	
SV	Press the SV key when you need to display the operation status display.	1 1 9 5

FUZY

FUZY control setting

[Description]

- This function is used to select or not to select FUZY control.
- FUZY control provides the following advantages.
 - Quick start without causing overshoot
 - Quick settlement in response to external disturbance.
- Use this function after setting P.I.D parameter to optimum value, using auto-tuning, etc.

Example) Set FUZY control to ON.

Key operation	Description	Display
SEL	Press the SEL key for 3 seconds, and P-n1 is displayed.	P - n 1
SEL	Press the SEL key repeatedly until FUZY is displayed.	F U Z Y
DATA	Press the DATA key. Current data is displayed.	0 F F
^ v	Press the (^) or (v) key to display ON.	o n
ENT	After pressing the ENT key, the data is registered.	
SV	Press the SV key when you need to display the operation status display.	1 1 9 5

Adj0

User's adjust zero adjustment (Setting range: -50 to 50%FS)

Adj5

User's adjust span adjustment (Setting range: -50 to 50%FS)

[Description]

- This function is used to calibrate input by user.
- Using zero input or span input, error is set in the input range.
- User calibration function is independent of adjustment of the controller. By setting 0 in this parameter, it can easily be set back to the state prior to delivery from the factory.
- It is used to set the same reading between controllers or between controller and recorder.

Example) Set zero adjustment to +1°C

Key operation	Description	Display
SEL	Press the SEL key for 3 seconds, and P-n1 is displayed.	P-n1
SEL	Press the SEL key repeatedly until ADJO is displayed.	Adj0
DATA	Press the DATA key. Current data is displayed.	0
▲ ▼	Press the ▲ or ▼ key to display 1.	1
ENT	After pressing the ENT key, the data is registered.	
SV	Press the SV key when you need to display the operation status display.	1195

Example)

When the input range is 0 to 400°C, the reading at 0°C input is -1°C and that at 400°C is 402°C.

In this case, when [ADJO] parameter is set to 1 and [ADJS] to -2, the reading at 0°C input becomes 0°C and that at 400°C input becomes 400°C.

When both [ADJO] and [ADJS] are set to 0, the controller is set in the calibrated state prior to delivery from the factory.

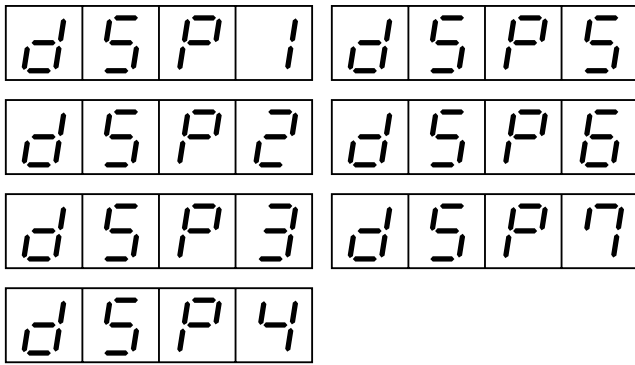

Skipping of parameter display

[Description]

- This parameter is used to skip parameter display for each item.
- This function can be used to prevent unused items from being displayed or set values from being changed by mistake.
- Correspondence of the setting of dSP1 to 7 and skipped items is shown below.
- It is possible to set the total code of items to be skipped.

Example) Skip I and D

Set $4 + 8 = 12$ according to dSP1 code table.

Key operation	Description	Display
SEL	Press the SEL key for 3 seconds, and P-n1 is displayed.	P - n 1
SEL	Press the SEL key repeatedly until dSP 1 is displayed.	dSP 1
DATA	Press the DATA key. Current data is displayed.	0
△ / ▽	Press the (△) or (▽) key to display 12.	12
ENT	After pressing the ENT key, the data is registered.	
SV	Press the SV key when you need to display the operation status display.	1195

Parameter	DSP allocation
PRoG	dSP1-1
P	dSP1-2
I	dSP1-4
D	dSP1-8
AL	dSP1-16
AH	dSP1-32
TC	dSP1-64
HYS	dSP1-128
Hb	dSP2-1
AT	dSP2-2
TC2	dSP2-4
CooL	dSP2-8
db	dSP2-16
PLC1	dSP2-32
PHC1	dSP2-64
PCUT	dSP2-128
bAL	dSP3-1
Ar	dSP3-2
LoC	dSP3-4
STAT	dSP3-8
SV-1	dSP3-16
TM1r	dSP3-32
TM1S	dSP3-64
SV-2	dSP3-128
TM2r	dSP4-1
TM2S	dSP4-2
SV-3	dSP4-4
TM3r	dSP4-8
TM3S	dSP4-16
SV-4	dSP4-32
TM4r	dSP4-64
TM4S	dSP4-128
MoD	dSP5-1

P-n1	dSP5-4
P-n2	dSP5-8
P-dF	dSP5-16
P-SL	dSP5-32
P-SU	dSP5-64
P-AL	dSP5-128
P-AH	dSP6-1
P-An	dSP6-2
P-dP	dSP6-4
RCJ	dSP6-8
PVOF	dSP6-16
SVOF	dSP6-32
P-F	dSP6-64
PLC2	dSP6-128
PHC2	dSP7-1
FUZY	dSP7-2
GAIN	dSP7-4
ADJO	dSP7-8
ADJS	dSP7-16
OUT	dSP7-32
dSP1	...
dSP2	...
dSP3	...
dSP4	...
dSP5	...
dSP6	...
dSP7	...

(Note 1) Registered function operates normally even when the display is skipped.

Troubleshooting

When trouble arises with the unit, check and remove the cause referring to the following table of troubleshooting.

Trouble	Cause	Remedy
Data are not displayed.	<ol style="list-style-type: none"> (1) Power is not supplied. (2) Unit is not connected to connector. (3) Instrument is in trouble. 	<ol style="list-style-type: none"> (1) Check power source. (2) Connect unit firmly to connector. (3) Replace instrument or contact your dealer for advice.
PV display is $\overline{\text{L}}$ $\overline{\text{L}}$ $\overline{\text{L}}$ $\overline{\text{L}}$ or $\overline{\text{L}}$ $\overline{\text{L}}$ $\overline{\text{L}}$ $\overline{\text{L}}$.	<ol style="list-style-type: none"> (1) Measured value is very high or low. (2) Input is not connected. (3) Sensor is damaged. 	<ol style="list-style-type: none"> (1) Check temperature of controlled object. (2) Connect input terminal. (3) Replace sensor or contact your dealer for advice.
Data are not changed at press of key.	<ol style="list-style-type: none"> (1) Unit is set in the position where parameter cannot be changed. (2) Unit is set over data setting range. 	<ol style="list-style-type: none"> (1) Check set value of parameter LoC (Page 22). (2) Check set values of parameter P-SL (Page 29) and P-SU (Page 29)
HB lamp ON	<ol style="list-style-type: none"> (1) Lamp is ON at detection of heater burnout. 	<ol style="list-style-type: none"> (1) Remove the cause of heater burnout.
Control output is not ON when output lamp (C1, C2) is ON.	<ol style="list-style-type: none"> (1) Output is disconnected. (2) Instrument is in trouble. 	<ol style="list-style-type: none"> (1) Check connection of output terminal. (2) Replace instrument or contact your dealer for advice.
Hunting of PV	<ol style="list-style-type: none"> (1) Input filter time constant is small. (2) Hysteresis is very large for 2-position action. (3) Control output proportional cycle is very large. (4) Improper adjustment of PID 	<ol style="list-style-type: none"> (1) Check set value of parameter P-dF (Page 26). (2) Check set value of parameter HYS (Page 12). (3) Check set value of parameter TC (Page 11), and TC2 (Page 16) control output 2. (4) Perform auto-tuning (Page 15).
Auto-tuning is not finished.	<ol style="list-style-type: none"> (1) Wrong wiring (2) Wrong setting of normal/reverse action of controller (3) Time constant of measured object is very long. 	<ol style="list-style-type: none"> (1) Check wiring between control object and controller. (2) Check set value of parameter P-n1 (Page 25). (3) It takes time for time constant. Wait until it is set.

Fuji Electric Systems Co., Ltd.

Head Office

Gate City Ohsaki, East Tower, 11-2, Osaki 1-chome,
Shinagawa-ku, Tokyo 141-0032, Japan
<http://www.fesys.co.jp/eng>

Instrumentation Div.

International Sales Dept.

No.1, Fuji-machi, Hino-city, Tokyo, 191-8502 Japan
Phone: 81-42-585-6201, 6202 Fax: 81-42-585-6187
<http://www.fic-net.jp/eng>