

**MICRO CONTROLLER E
Z SERIES**

TYPE: PYZ 4

5

7

9

INTRODUCTION

You are now the owner of Fuji's Digital Temperature Controller.
Before using, be sure to check the instrument for correct specifications.
This instruction manual has been prepared for final users.

The product conforms to the requirements of the Electromagnetic compatibility Directive 89/336/EEC as detailed within the technical construction file number TN510404. The applicable standards used to demonstrate compliance are :

EN 50081-1 : 1992 Conducted and Radiated emissions

EN 50082-1 : 1992 Radiated immunity, ESD and FBT

(The unit meets Class A limits for conducted Emissions.)

The unit also complies with the part of Immunity standards.

IEC 1000-4-2 : 1995 level 3, IEC 1000-4-3 : 1995 level 3

IEC 1000-4-4 : 1995 level 3, IEC 1000-4-8 : 1993 level 4

CONTENTS

	Page
Introduction	i
1. Functions of their keys and displays	1
2. Operation	2
2.1 Preparation for operation	2
3. Fault indication	6
4. Use of dual output type (option)	7
5. Use of heater break alarm (option).....	8
6. Change of functions	10
6.1 Kinds of second parameter and meanings	10
6.2 Function setting	11
7. Outline dimensions and panel cutout	16
8. Terminal connection diagram	17
9. Control/alarm output and indicating lamp	19
10. Cautions for installation and wiring	20
11. Specifications	23
12. Ordering code	24

1. FUNCTIONS OF THEIR KEYS AND DISPLAYS

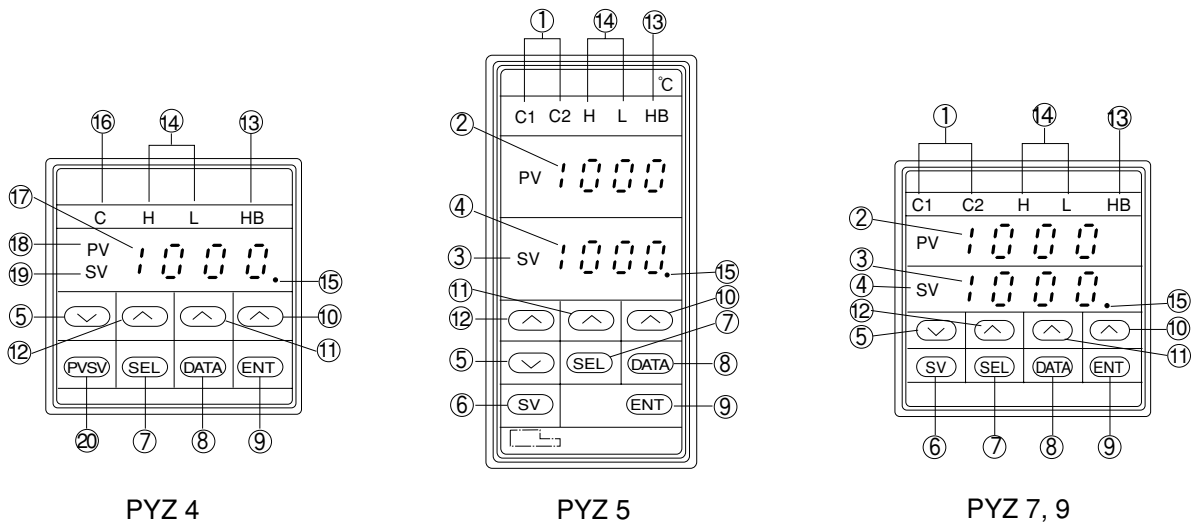

Fig. 1

Table 1

Item	Function
① Control output lamp (green)	C1: Control output "1" indication (lamp is lit at ON) C2: Control output "2" indication(lamp is lit at ON) (option)
② Measured value (PV) lamp (red)	Indication of measured value
③ Set value (SV) lamp (green)	Lamp is lit while indicating set value (SV).
④ Parameter lamp (green)	Indication of set value (SV) and various parameters (PID, high/low alarm, heater break alarm, etc.)
⑤ Down-key (common to all digits)	Numeric value of digit selected by up-key goes down. When parameters do not flicker, press the key. Parameters are indicated sequentially. (SEL) key indication and Down-key indication are reverse.
⑥ Direct SV select key	Set value (SV) is indicated by pressing this key.
⑦ Parameter select key	Parameters are indicated in order at each press of this key.
⑧ Data key	Indication of parameter data selected by parameter select key. Data are registered after they have been changed.
⑨ Data entry key	(Changed data cannot be registered unless this key is pressed.)
⑩ 1-digit up-key	Numerical value of digit flickers at a press. It goes up while repeating to press this key.
⑪ 10-digit up-key	Numeric value of 10-digit flickers at a press. It goes up while repeating to press this key.
⑫ 100-digit up-key	Numeric value of 100-digit flickers at a press. It goes up while repeating to press this key. It returns to "0" after it reaches "9" and, at the same time, the 1000th digit goes up by "1".
⑬ Heater break alarm lamp (red)	Lamp is lit at ON of heater break alarm output (option)
⑭ Alarm lamp (red)	H : Lamp is ON at high alarm (option) L : Lamp is ON at low alarm (option)
⑮ Auto tuning lamp	Lamp flickers during PID auto tuning.
PYZ4 { ⑯ Control output lamp (green)	Lamp is lit at ON of control output.
⑰ Parameter indication	Indication of measured value (PV), set value (SV) and various parameters.
⑱ Measured value (PV) lamp (red)	Lamp is lit at indication of measured value (PV)
⑲ Set value (SV) lamp (red)	Lamp is lit at indication of set value (SV)
⑳ PV/SV select key	Selection of measured value (PV) or set value (SV) at each press of this key

2. OPERATION

Turning ON the power, the measured value (PV) and set value (SV) indicators show $\square.\square.\square.\square$. A measured value and set value are indicated a few seconds later, and then this controller starts to operate.

2.1 Preparation for operation

To ensure correct operation of the controller, it is necessary to set parameters fitted to the controlled system before operating, according to the procedures shown in (2) setting method of parameters. While setting parameters, be sure to turn OFF the operation of the operation terminal side for the sake of safety.

For changing the ordered specifications after purchase, refer to "6. CHANGE OF FUNCTIONS".

The controller (PYZ) unit requires about 2 hours for thermal stability.

Be sure to start measurements after 2 hours or more since the power has been turned ON.

(1) Kinds of parameters and meaning

Table 2.1 List of first block parameters shows kinds of parameters of the controller and meaning. Note that some parameters are not indicated depending on the code symbols specified by you.

Pressing the SEL key, parameters are indicated in the order of SV→P→I→LoC→SV. Pressing the V key, parameters are indicated in the order of SV→LoC→P→SV. (When the data of parameters are indicated, the parameters can not be changed by these operations.) To return indicating SV, with another parameter indicated, press the SV key.

(2) Setting method of parameters

Refer to the Table 2-2, 2-3 (page 5) to set each value of parameters.

When the PID value has not been determined at the operation with PID action, the auto tuning function should be used.

(3) Second block parameters

This controller is provided with the second block parameter to determine the controllers functions besides the functions shown in "List of the first block parameter". Refer to "List of the second block parameter" (page 10).

(4) If it is left for 30 seconds after key operation, the parameter indication is reset to SV indication automatically. (In case of PYZ4, the parameter is turned to PV indication.)

(5) Minus value setting

When altering plus sign to minus, press the V key after setting all digits to "0". Then, minus numeral values shall be indicated. Set the value to the required value by operating the ^ key or the V key.

When altering minus sign to plus, press the ^ key after setting all digits to "0". Then, the minus code (–) shall disappear. Set the value to the required value by operating the ^ key or the V key.

(6) Auto-tuning (AT) operation

The PID parameters can be automatically measured, calculated and set by the controller using auto-tuning function.

The auto-tuning should be performed when P.I.D value has not been set before operating P.I.D mode.

(a) The auto-tuning function should be used after the set value (SV), alarm setting (AL, AH) and proportional cycle (TC) [Reference: SSR/SCC drive output; 2 sec, contact output; 30 sec.] are set up.

(b) Meaning of auto-tuning data

0: Auto-tuning is disable

1: Standard type auto-tuning
PV is compared with Sv during auto-tuning.

2: Low PV type
PV is compared with (SV-10%FS) during auto-tuning.

(c) Auto-tuning startup operation

- Press the parameter select key (SEL) to indicate AT:  (AT).

- Press the Data key (DATA) to indicate auto-tuning data. Auto-tuning disable code "0" is indicated. 

- Press the 1-digit up-key (▲) for setting the code of auto-tuning. (Standard type: 1 Low PV type: 2) 

- Press the 1-digit up-key (▲) to set "1" when the standard type auto-tuning is required. The auto-tuning of the standard type is executed. (When the low-PV type auto-tuning, set "2".) 

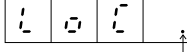
- Press the Data entry key (ENT) to start auto-tuning. The auto-tuning lamp flickers during auto-tuning. 

Auto-tuning lamp
(decimal point on
the 1st digit)

- Press the direct SV select key or PV/SV select key to indicate SV.

- At the end of auto-tuning, flashing goes off and the auto-tuning parameter At is automatically reset to "0" and changed automatically to the next parameter.

(d) When the auto-tuning is completed, the PID parameter is saved even if the power is turned OFF. Auto-tuning is not required again for the following operation. However, the auto-tuning should be performed from the beginning when the power is turned OFF in the middle of auto-tuning.

(e) During auto-tuning, it is under ON-OFF operation (2-position operation) and PV may be oscillated greatly depending on process. If it is not desirable, do not use the auto-tuning function.

(f) Do not use auto-tuning for a quick response process such as pressure control, flow control, etc.

(g) When auto-tuning is not completed within 4 hours, it means that the auto-tuning function is abnormal. In such a case, check the control system (input/output wiring) and also check to make sure that the control output operation conforms with the controlled object. Then, repeat the auto-tuning once again.

(h) When SV has largely changed or the process operating condition has been changed, carry out the auto-tuning again.

(i) During auto-tuning, PV and the output vary as shown in Figs. 2-1 and 2-2.

(7) With the PYZ left for 30 seconds after key operation, the parameter indication is reset to SV indication automatically. (In case of PYZ4, the parameter is reset to PV indication.)

Standard type

Low PV type

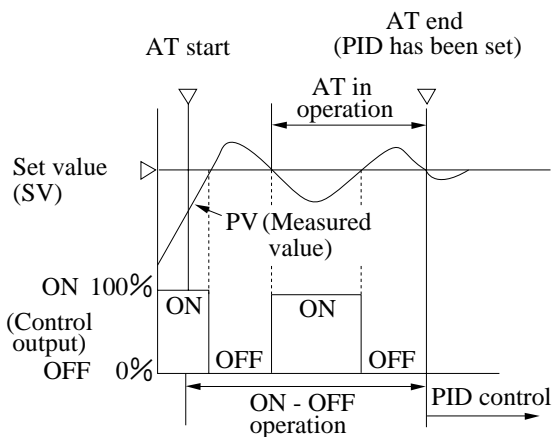

Fig. 2-1

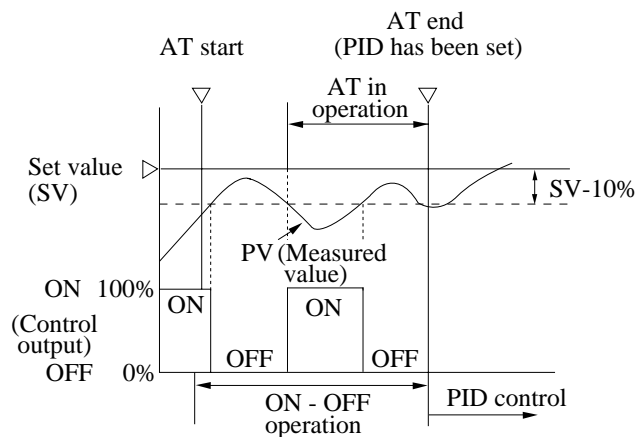

Fig. 2-2

Note) When AT lamp is lit, it is an indication of ON-OFF operation (2-position operation), and measured value (PV) is fluctuated.

List of first block parameters

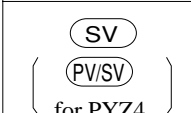
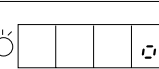
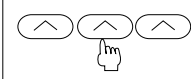
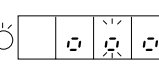
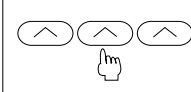

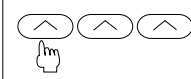
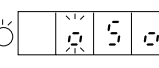

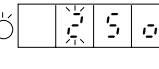

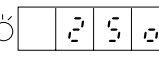

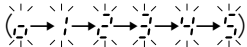
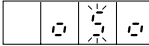



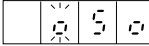





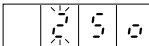

Table 2-1

Parameter symbol	Item	Meaning	Description	Initial value prior to delivery	Remarks
SV	SV	Set value	Settable within the input range	"0" or ordering specification	
P	P	Proportional band	Setting range: 0.0 to 999.9% (at input range)	3.0	2-position operation* at setting "0" (TC should also be set to "0")
I	I	Integral time	Setting range: 0 to 9999 sec.	0	Integral operation is OFF at "0".
D	D	Derivative time	Setting range: 0 to 3600 sec.	0	Derivative operation* is OFF at "0".
AL	A L	Low	Settable within the input range. Lower limit value of the alarm is set.	10	Not indicated without alarm function.
AH	A H	High	Settable within the input range. Upper limit value of the alarm is set.	10	Not indicated without alarm function.
TC	TC	Proportional cycle of control output 1	Proportional cycle of control output 1 is settable. Setting range: 1 to 150 sec.	Contact output :30 SSR drive output: 2	Not indicated at current output.
HYS	HYS	Hysteresis width of 2-position operation	Setting range: 0.0 to 20.0%FS Hyeresis width at 2-position operation is settable.	0.3	
Hb	Hb	Heater break alarm	Setting range: 0 to 50.0A. Operation value to detect heater break is settable. (Option)	0.0	The alarm function is OFF at "0.0". Not indicated without heater break alarm function.
AT	AT	Auto tuning	Used for setting PID parameters by auto-tuning function. 0: Disable or reset auto-tuning 1: Standard type auto-tuning at SV 2: Lower PV type auto-tuning at SV-10FS	0	Auto-tuning is started when "AT" hasbeen set to "1" or "2" and the "AT" is automatically reset to "0" at the end of Auto-tuning.
TC2	TC2	Proportional cycle of control output 2	Proportional cycle of control output 2 is settable. Setting range: 1 to 150 sec.	Contact output :30 SSR drive output: 2	Not indicated without function of control output 2 and at current output.
Cool	Cool	Proportional band coefficient of cooling side	Cooling side proportional band factor is settable (setting range: 0, 0.1 to 99.9) ON-OFF operation at setting "0"	1.0	Not indicated without function of control output 2.
db	db	Proportional band shift of cooing side	Cooling side output value is shifted. Setting range: -50.0 to +50.0	0.0	Not indicated without function of control output 2
PLC1	PLC1		Setting need not be changed	Specified by manufacturer	
PHC1	PHC1		Same as above	Specified by manufacturer	
BAL	BAL		Same as above	Specified by manufacturer	
AR	AR		Same as above	Specified by manufacturer	
LoC	LoC	Key lock	Selecting "able" or "disable" of changing of parameter set value. 0: All parameter set values are changeable 1: Inhibit changing the all parameter set values. 2: Inhibit changing the all parameter set values other than "SV"	0	

Caution: Each parameter should be used within the setting range shown in the instruction manual.
If it is used beyond the setting range, it can result in unexpected trouble.





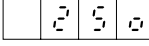





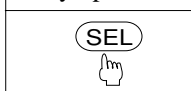
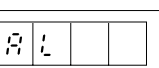

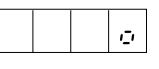

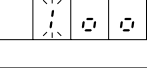

Setting of set value (SV)

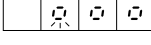
Table 2-2

Contents of operation	Setting of SV to 250	
Key operation	Description	Indication
  (for PYZ4)    	<ul style="list-style-type: none"> Press the (SV) key to indicate set value. (This operation can be omitted when a set value is indicated.) 	SV \ddot{O} 
   	<ul style="list-style-type: none"> Press (\wedge) key of any digit to be set. In this example, the (\wedge) key of 10-digit is pressed. The 10-digit indication flickers. 	SV \ddot{O} 
   	<ul style="list-style-type: none"> Press the (\wedge) key (5 times) to indicate "5".  	SV \ddot{O} 
   	<ul style="list-style-type: none"> Press (\wedge) key of 100-digit. The 100-digit indication flickers. 	SV \ddot{O} 
   	<ul style="list-style-type: none"> Press the (\wedge) key (2 times) to indicate "2".  	SV \ddot{O} 
 	<ul style="list-style-type: none"> Press the (ENT) key. The indication stops flickering and the set value 250°C is indicated. — Operation is completed. — 	SV \ddot{O} 

Setting of low alarm (AL)

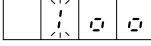
Table 2-3

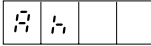
Contents of operation	Setting of low alarm (AL) from 0 to 100	
Key operation	Description	Indication
 	<ul style="list-style-type: none"> Press the (SEL) key to indicate \overline{AL}. ($\overline{AL} \rightarrow \overline{L} \rightarrow \overline{L} \rightarrow \overline{AL}$) 	\overline{AL} 
 	<ul style="list-style-type: none"> Press the (DATA) key to indicate data. Latest alarm set value is displayed. (In this example, "0") 	
   	<ul style="list-style-type: none"> Press (\wedge) key of any digit to be set. In this example, the indication of 100-digit flickers. 	
   	<ul style="list-style-type: none"> Press the (\wedge) key (once) to indicate "1".  	
 	<ul style="list-style-type: none"> Press the (ENT) key. Indication stops flickering, and the alarm set value "100" is set and indicated. The indication is shifted automatically to the next parameter. 	\overline{AL} 

3. FAULT INDICATION

The controller has a fault indicating function so that the cause of fault can be removed quickly. After the cause has been removed, be sure to turn off and then turn on the power switch.

Table 3-1

Indication	Cause	Control output
	① Burnout of thermocouple sensor (upscale burnout) ② Burnout of resistance bulb sensor (upscale burnout)	① In case of upscale burnout (standard) OFF or less than 4 mA in reverse action ON or more than 20 mA in normal action ② In case of downscale burnout ON or more than 20 mA in reverse action OFF or less than 4 mA in normal action
	① Burnout of thermocouple sensor (downscale burnout) ② Burnout of resistance bulb sensor (downscale burnout)	
	① PV reading is more than "the range upscale value +30% FS" (Note)	Goes on control Note) Even when the PV value is over the range within +30% FS, it becomes sensor burnout display, and the control output is output, if the input voltage exceeds the burnout detecting point.
	① Short-circuit of resistance bulb sensor (between A and B) ② PV reading is less than "the range downscale value -30% FS" (Note)	
HB Lamp ON	Heater burnout	Normal control

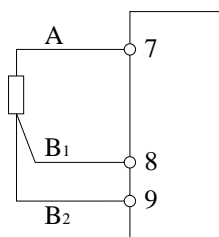

PYZ7

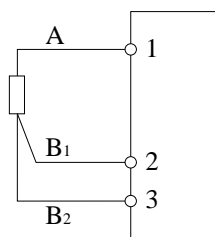

PYZ4
PYZ5
PYZ9

4. USE OF DUAL OUTPUT TYPE (OPTION)

(1) Function description

The dual output type has 2 control outputs for one input signal and set value (SV). Control output 1 is used for heating, while control output 2 is used for cooling, respectively. Output signal is any combination with contact output, SSR drive output and 4 to 20mA DC output which are available according to the code symbols. The dual output type has the parameters TC2, cool, db in addition to those of the standard type.

In dual type, the proportional band of control output 1 is $P/2$. The proportional band of control output 2 is described below. However, the max. value should be limited to $P/2$.

By setting the parameter cool to 0.0, cooling control is set to ON-OFF control. (Note that hysteresis is not attached.)

Example: In case of $P = 20$ (%) and $cool = 0.5$ proportional band of control output 2 = $20 \times 0.5 = 10$ (%)

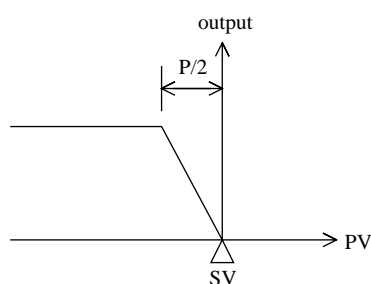

Fig. 4-1

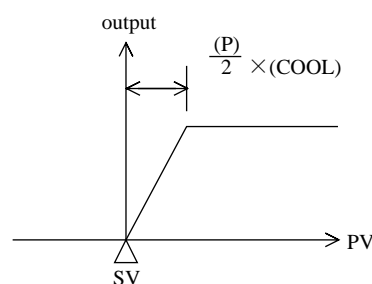

Fig. 4-2

The control output 2 value corresponding to deviation can be changed. This can be changed according to setting of parameter dB.

(When dB is plus)

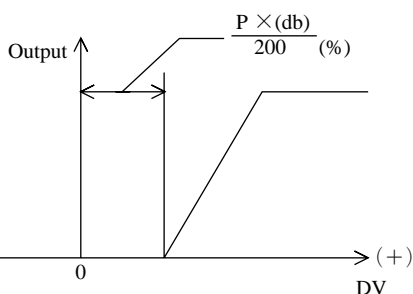

Fig. 4-3

(When dB is minus)

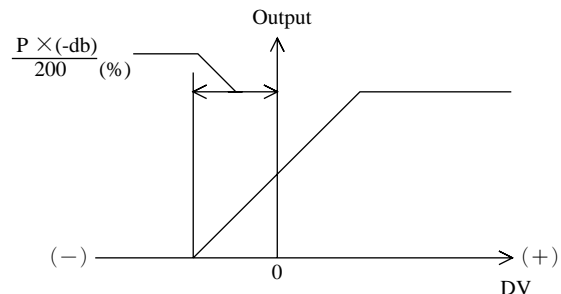

Fig. 4-4

(2) The tuning of dual output type

In the dual output type controller, the PID auto-tuning is not effective.

During PID auto-tuning, the cooling side output is OFF. After the auto-tuning, both the heating and cooling sides are operated with the same PID value.

Then set PID parameters, parameter cool and parameter dB with front panel keys.

During PID control, both the heating and cooling sides are the same in setting and operation. PID operation cannot be set individually. When the heating side is set in 2-position operation, the cooling side is also set in 2-position operation.

5. USE OF HEATER BREAK ALARM (OPTION)

- The current detector (CT) comes in 2 types, 0-30A type (CTL-6-SF) and 20-50A type (CTL-12-S36-8F). It should be set to the heater current being used.
- For setting alarm point, the parameter Hb is used.
- Setting of alarm set point
 - ① With the controller output set to ON, apply a current to the heater.
 - ② While changing the alarm set point, locate the value at which the alarm operates (when changing the set point, be sure to wait for 3 seconds or more).
 - ③ When the operating point has been set, the final set point should be 70 to 80% of the operating point.
- By using a power common to the heater and this controller, the variation of the alarm operating point due to power fluctuation can be minimized.
Set the parameter Tc for 6 sec. or more.
- To use heater alarm functions properly, set the second parameter P-CT to heater power voltage value.
- When heater is controlled with an actuator controlling phase angle, the heater break alarm can not be used.
- Connection of heater burnout detecting CT

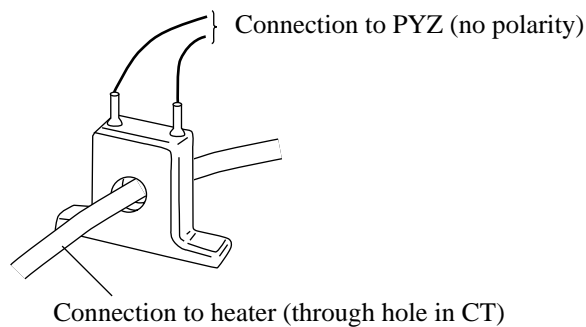

Fig. 5-1

- Connection example of heater break alarm (Type PYZ5, 9)

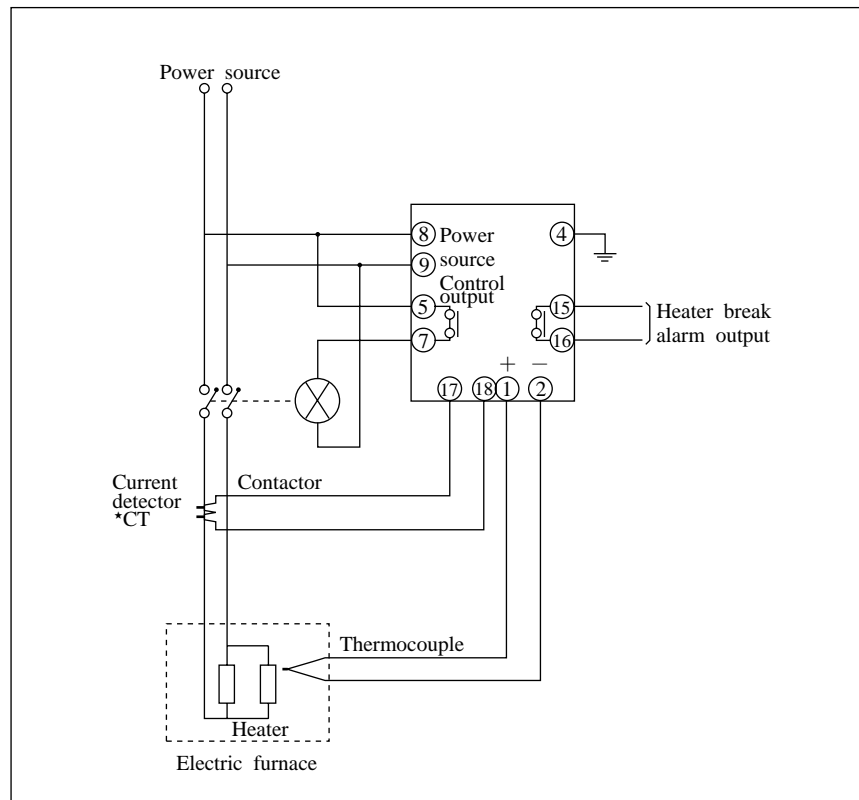

Fig. 5-2

Read the following when changing the functions of this controller.

6. CHANGE OF FUNCTIONS

The function specifications of this controller can be changed by changing the second block parameters. To change the functions, the second parameter should be called out.

6.1 Kinds of second parameter and meanings

Table 6-1 shows a list of second parameters and their meanings.

To call out of second parameter, operate the keys in the following order.

After the parameter "P" has been selected, press the (SEL) key for about 5 seconds. In this way, the indicator shows "P-n!" and the controller is set in the second parameter mode. To return to the first block parameter mode, display "P-n!" and then press the (SEL) key for about 5 seconds.

When the key is not operated for 30 sec. or more, the parameter indication is reset to SV indication mode of the first block parameter. (Note that it is reset to PV indication mode is case of PYZ4.)

List of second block parameters

Table 6-1

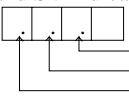
Parameter symbol	Item	Meaning	Description	Initial value prior to delivery
P-n1	P-n1	Control operation	Setting of direct/reverse operation, and setting of burnout direction	Ordering specification
P-n2	P-n2	Input type	Setting of input signal type	Ordering specification
P-dF	P-dF	Input filter time constant	Half of code value is time constant (sec.) (code : 0 to 201)	Code 20 (time constant ; 10 sec)
P-SL	P-SL	Lower limit of input range	Setting of lower limit value of input range	Ordering specification
P-SU	P-SU	Upper limit of input range	Setting of upper limit value of input range	Ordering specification
P-Ab	P-Ab	Alarm type	Setting of alarm operation type	Ordering specification Unless otherwise specified, the function code 79(high/low limit deviation alarm) is set.
P-An	P-An	Hysterisis of alarm	Setting of hysteresis width then alarm output ON-OFF Setting range: 0-255°C/°F	1
P-dP	P-dP	Decimal point position	Selection of the position of decimal point on the PV and SV indicator  Code 0 : without decimal point Code 2 Code 4 Code 8	Ordering specification
P-48	P-48		Parameter peculiar to the model. Do not change.	Specified by manufacturer
P-CT	P-CT	Setting of heater rated voltage	When using heater burnout alarm, be sure to set the rated power voltage for the controller (setting range:85-265V)	100
PVOF	PVOF	PV offset	PV indicated value is shifted, however PV is unchanged. (Setting range: -1999 to +2000)	0
SVOF	SVOF	SV offset	SV indicated value is shifted, however SV is unchanged. (Setting range: -1999 to +2000)	0
P-F	P-F	°C/°F selection of measured value input	Only the measured values are changed over, so other parameters need to be changed. °C display : 0 °F display : 1	Ordering specification $PV (°F) = \frac{9}{5} PV (°C) + 32$
PLC2	PLC2		Setting need not be changed	Specified by manufacturer
PHC2	PHC2		Same as above	Specified by manufacturer
dSP1	dSP1	Skipping first block parameters	Used to set desired parameters P, I, D, AL, AH, TC, HYS for display.	
dSP2	dSP2		Same as above for Hb, AT, TC2, COOL, db, PLC1, PHC1, PCUT.	
dSP3	dSP3		Same as above for BAL, AR	

6.2 Function setting

(1) Method of changing input type specifications

Input can be changed shown below.

(a) Change of thermocouple type

Select the parameter "P - r₁c". Set the code of desired thermocouple shown in table 6-2.

(b) Change from the thermocouple to resistance bulb

- Turn off the power of the controller, and pull out the controller from the case or the socket.
- Change the input select socket to RTD (resistance bulb) side.
- Set the controller into the case or on the socket, and turn on the power.
- Change to the second block parameter, and select the parameter P - r₁c.

(c) Change from resistance bulb to thermocouple select the parameter P - r₁c

- Turn off the power of the controller, and pull out the controller from the case or the socket.
- Change the input select socket to TC (thermocouple) side.
- Set the controller into the case or on the socket, and turn on the power.
- Change to the second block parameter, and select the parameter P - r₁c.

Set the code of desired thermocouple.

(d) Change from DC 1 to 5V DC input to DC 4 to 20mA DC input

Connect a resistor (250Ω) to input terminal. The resistor should be purchased by user.

(e) Change from 4 to 20mA DC to 1 to 5V DC

Remove the resistor (250Ω) connected at input terminals.

(f) Change from thermocouple or resistance bulb to 1 to 5V DC or 4 to 20mA DC.

In this case, changing is not usable.

For input type code, refer to table 6-2. For changeover of internal switch, refer to Fig. 6-1 through 6-4.

Input type and code

Type	Code
Resistance bulb	
· Pt 100 (IEC)	0
Thermocouple	
· J	2
· K	3
· R	4
· S	6
· T	7
· N	12
· PL-II	13
Voltage/current	
· 1 ~ 5V DC	31
· 4 ~ 20mA DC	31

PYZ4
(socket type)

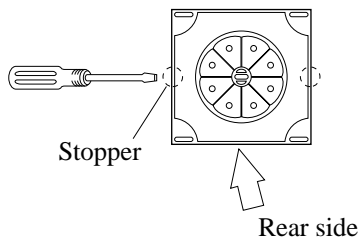

Attach a flat blade screwdriver to the hooks on the rear at the left and right sides to open the case, then push the inside of the main unit with finger tip.

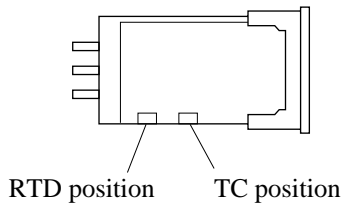

Set the small socket to RTD position or TC position.

Fig. 6-1

PYZ5

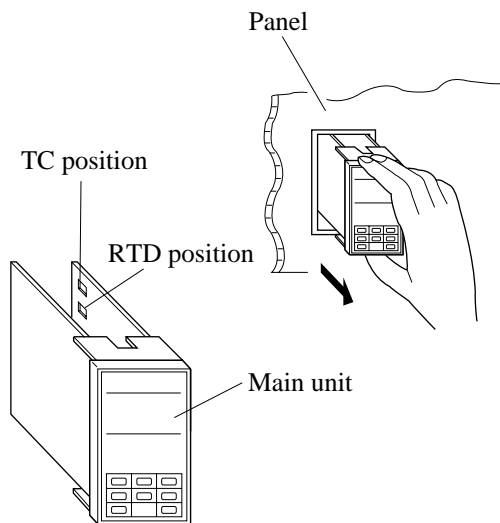

Push down until the lock is released.

Set the small socket to RTD position or TC position.

Fig. 6-2

PYZ7

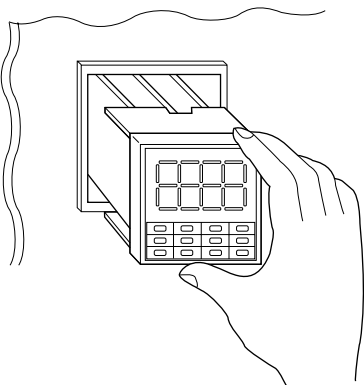

Push down until the lock is released.

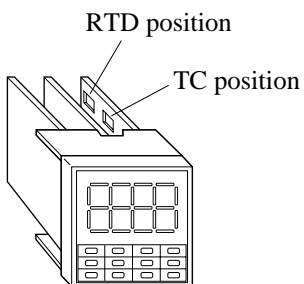

Set the small socket to RTD position or TC position.

Fig. 6-3

PYZ9

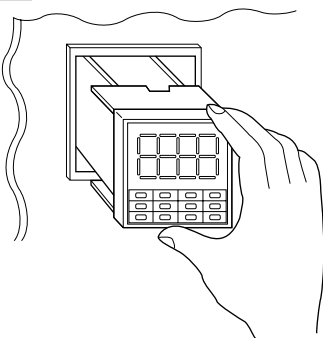

Push down until the lock is release.

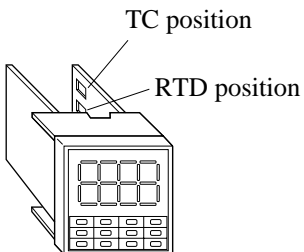

Set the small socket to RTD position or TC position.

Fig. 6-4

(2) Change of control action

Select the second parameter "P - r ;" and set the function code as shown in Table 6-3 and 6-4.

Definition of reverse action and direct action

○ Reverse action

This is used to control temperature by heating. When the temperature is higher than the set value, the controller output decreases.

○ Direct action

This is used to control temperature by cooling. When the temperature is higher than the set value, the controller output increases.

For wire-break of thermocouple input and RTD input, the input value becomes the value specified by burnout direction.

As a result, when wire-break direction is set to upper limit and control output is set to reverse action, for example, the control output goes to lower limit in wire-break of input.

Table 6-3

Standard type					
Function code	Burnout direction	Control output 1	Function code	Burnout direction	Control output 1
0	Upper limit	Reverse action	1	Lower limit	Reverse action
16	Upper limit	Direct action	17	Lower limit	Direct action

Note) Function codes "0" and "17" : Standard

Table 6-4

Dual output type							
Function code	Burnout direction	Control output 1	Control output 2	Function code	Burnout direction	Control output 1	Control output 2
2	Upper limit	Reverse action	Direct action	3	Lower limit	Reverse action	Direct action
18	Upper limit	Direct action	Direct action	19	Lower limit	Direct action	Direct action
34	Upper limit	Reverse action	Reverse action	35	Lower limit	Reverse action	Reverse action
50	Upper limit	Reverse action	Reverse action	51	Lower limit	Direct action	Reverse action

Note) Function codes "2" and "3" : Standard

(3) Change of alarm operation (option)

Alarm operation has 18 types of functions.

Select the second parameter "P - PZ;" and set the function code as shown in Table 6-5. Then the alarm type can be changed.

The low alarm hold function inhibits the low alarm output at the beginning when the power of the controller is turned on.

By setting the upper/lower alarm in case of PYZ4, the alarm output is obtained by OR of upper and lower alarms.

In this case, their alarms can be displayed independently on the front panel.

On the high/high limit deviation alarm, the low-limit set value should be set in negative value using the high/low-limit function.

Table 6-5

Function		Action	Function code	Description	
Deviation alarm	High/low alarm Without low alarm hold		15	Upper limit (H) and lower limit (L) for set value (SV). Alarm output is ON in the hatched area .	
	High alarm		10		
	Low alarm Without low alarm hold		5		
	High/low alarm With low alarm hold		79 (standard)		
	Low alarm With low alarm hold		69		
Absolute value alarm	High/high alarm ※		19	Upper limit (H) and lower limit (L) within the range (0 to 100%). Alarm output is ON in the hatched area .	
	High/low alarm Without low alarm hold		3		
	High alarm		2		
	Low alarm Without low limit hold		1		
	High/low alarm With low alarm hold		67		
	Low alarm With low alarm hold		65		
	Low/low alarm ※ Without low alarm hold		35		
Absolute value+Deviation alarm	Absolute value High	Deviation High ※		23	Alarm output is ON in the hatched area .
	High alarm	Low alarm		7	
	Low alarm	High alarm		11	
	Low alarm With low alarm hold	High alarm		75	
	High alarm	Low alarm With low alarm hold		71	
Zone alarm	Low alarm	High alarm		179	Alarm output is ON within the range between low alarm set value and high alarm set value. Alarm is output to Alarm 2 terminal (PYZ5, PYZ7, PYZ9)
	Deviation	Absolute value		183	
	Absolute value	Deviation		187	
	Deviation	Deviation		191	

※ in case of PYZ5, 7 and 9.

7. OUTLINE DIMENSIONS AND PANEL CUTOUT

(Unit: mm)

Type	Outline dimensions	Panel cutout																																																
PYZ5 PYZ7 PYZ9	<table border="1"> <thead> <tr> <th>Type</th> <th>A</th> <th>B</th> <th>C</th> <th>D</th> <th>E</th> <th>F</th> <th>G</th> <th>H</th> </tr> </thead> <tbody> <tr> <td>PYZ5</td> <td>48</td> <td>96</td> <td>90.5</td> <td>114.5</td> <td>45^{+0.6}₀</td> <td>92^{+0.8}₀</td> <td>116MIN</td> <td>50MIN</td> </tr> <tr> <td>PYZ7</td> <td>72</td> <td>72</td> <td>67</td> <td>91</td> <td>68^{+0.7}₀</td> <td>68^{+0.7}₀</td> <td>92MIN</td> <td>82MIN</td> </tr> <tr> <td>PYZ9</td> <td>96</td> <td>96</td> <td>90.5</td> <td>114.5</td> <td>92^{+0.8}₀</td> <td>92^{+0.8}₀</td> <td>115MIN</td> <td>100MIN</td> </tr> </tbody> </table>	Type	A	B	C	D	E	F	G	H	PYZ5	48	96	90.5	114.5	45 ^{+0.6} ₀	92 ^{+0.8} ₀	116MIN	50MIN	PYZ7	72	72	67	91	68 ^{+0.7} ₀	68 ^{+0.7} ₀	92MIN	82MIN	PYZ9	96	96	90.5	114.5	92 ^{+0.8} ₀	92 ^{+0.8} ₀	115MIN	100MIN	<p>PYZ5 tight mounting Note 1)</p> <table border="1"> <thead> <tr> <th>Q'ty</th> <th>2</th> <th>3</th> <th>4</th> <th>5</th> <th>6</th> </tr> </thead> <tbody> <tr> <td>a</td> <td>93</td> <td>141</td> <td>189</td> <td>237</td> <td>285</td> </tr> </tbody> </table>	Q'ty	2	3	4	5	6	a	93	141	189	237	285
Type	A	B	C	D	E	F	G	H																																										
PYZ5	48	96	90.5	114.5	45 ^{+0.6} ₀	92 ^{+0.8} ₀	116MIN	50MIN																																										
PYZ7	72	72	67	91	68 ^{+0.7} ₀	68 ^{+0.7} ₀	92MIN	82MIN																																										
PYZ9	96	96	90.5	114.5	92 ^{+0.8} ₀	92 ^{+0.8} ₀	115MIN	100MIN																																										
Q'ty	2	3	4	5	6																																													
a	93	141	189	237	285																																													
PYZ4	<p>Horizontal tight mounting</p> <p>Vertical tight mounting</p>	<p>Mounting of N units</p> <p>Tight mounting Note 1), Note 2)</p> <p>Horizontal tight mounting</p> <p>Vertical tight mounting</p> <table border="1"> <thead> <tr> <th>Q'ty</th> <th>2</th> <th>3</th> <th>4</th> <th>5</th> <th>6</th> </tr> </thead> <tbody> <tr> <td>a</td> <td>93</td> <td>141</td> <td>189</td> <td>237</td> <td>285</td> </tr> </tbody> </table>	Q'ty	2	3	4	5	6	a	93	141	189	237	285																																				
Q'ty	2	3	4	5	6																																													
a	93	141	189	237	285																																													
CT for Heater break alarm	<p>for 0 to 30A Type CTL-6-SF</p> <p>for 20 to 50A Type CTL-12-S36-8F</p>																																																	

- Note 1) When the power source voltage is more than 200V, it is recommended to use a ventilating fan.
100V AC power should be used for vertical tight mounting (use of a ventilation fan is recommended).
- Note 2) When using 11-pin TP311SB socket, horizontal tight mounting is not available.
- Note 3) Vertical tight mounting is available only for ATXINS, 11GB socket.

8. TERMINAL CONNECTION DIAGRAM

PYZ4□□□□-0□ (Standard)

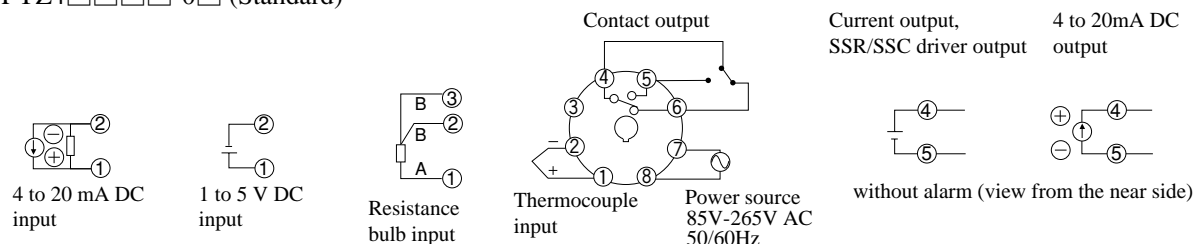

Fig. 8-1 (view from the rear side)

PYZ4□□□□-1□ (With alarm)

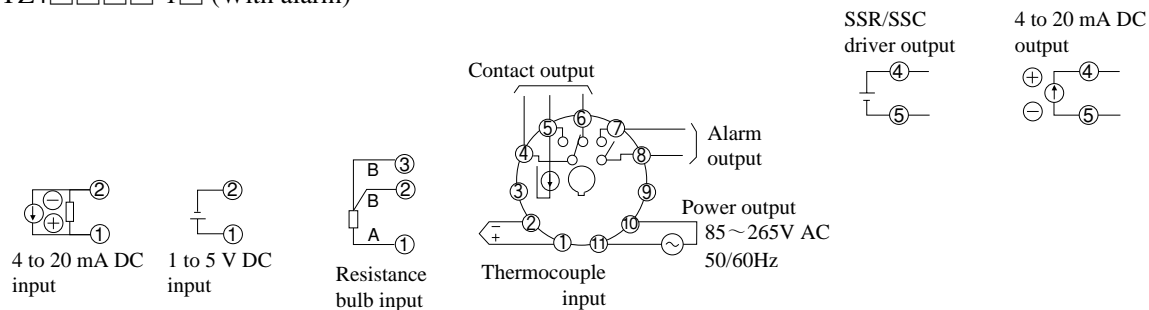

Fig. 8-2 (view from the rear side)

PYZ5, 9

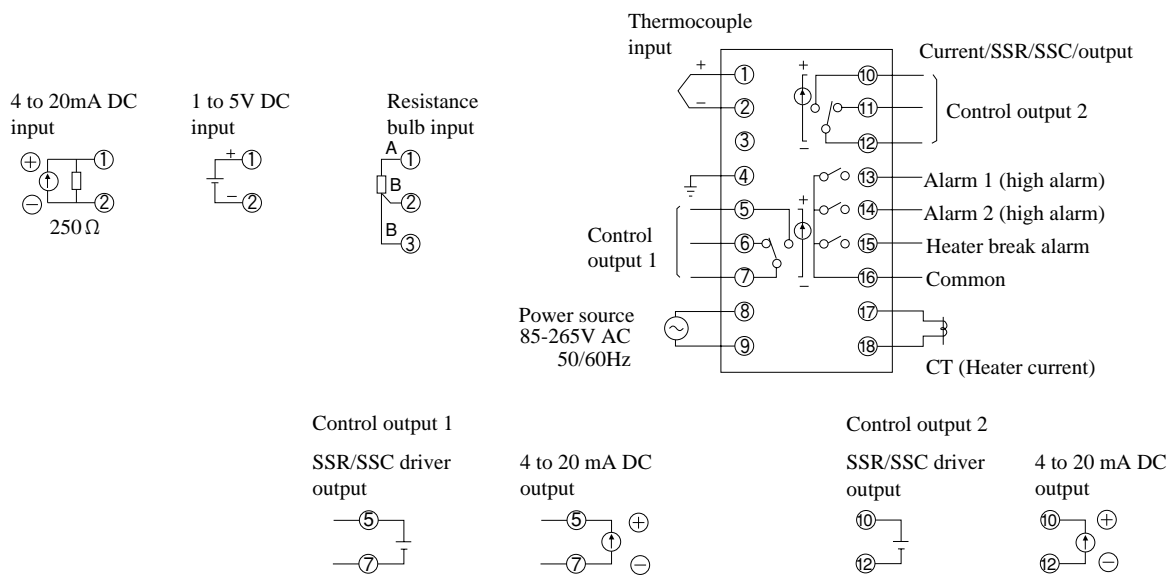

Fig. 8-3

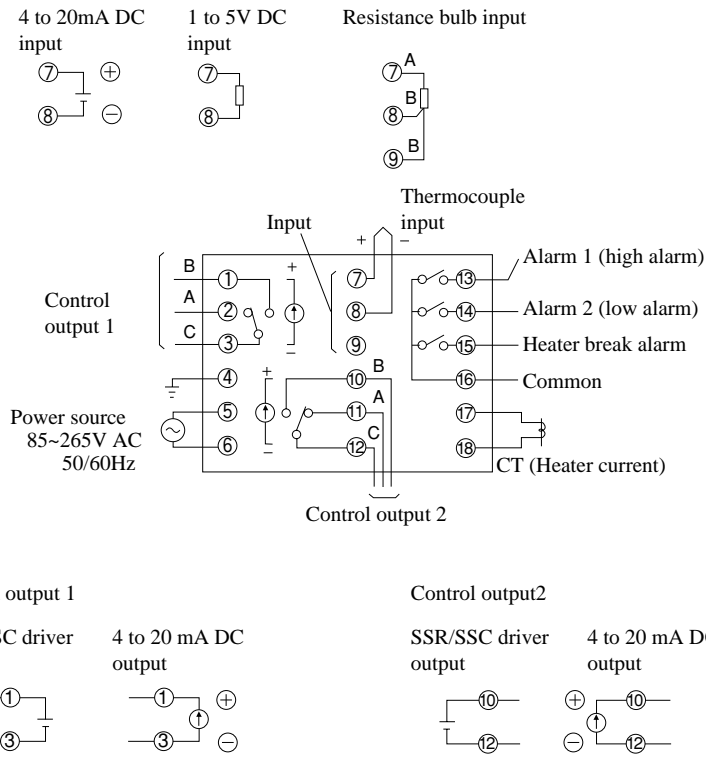

Fig. 8-4

9. CONTROL/ALARM OUTPUT AND INDICATING LAMP

- Output and indication during operation

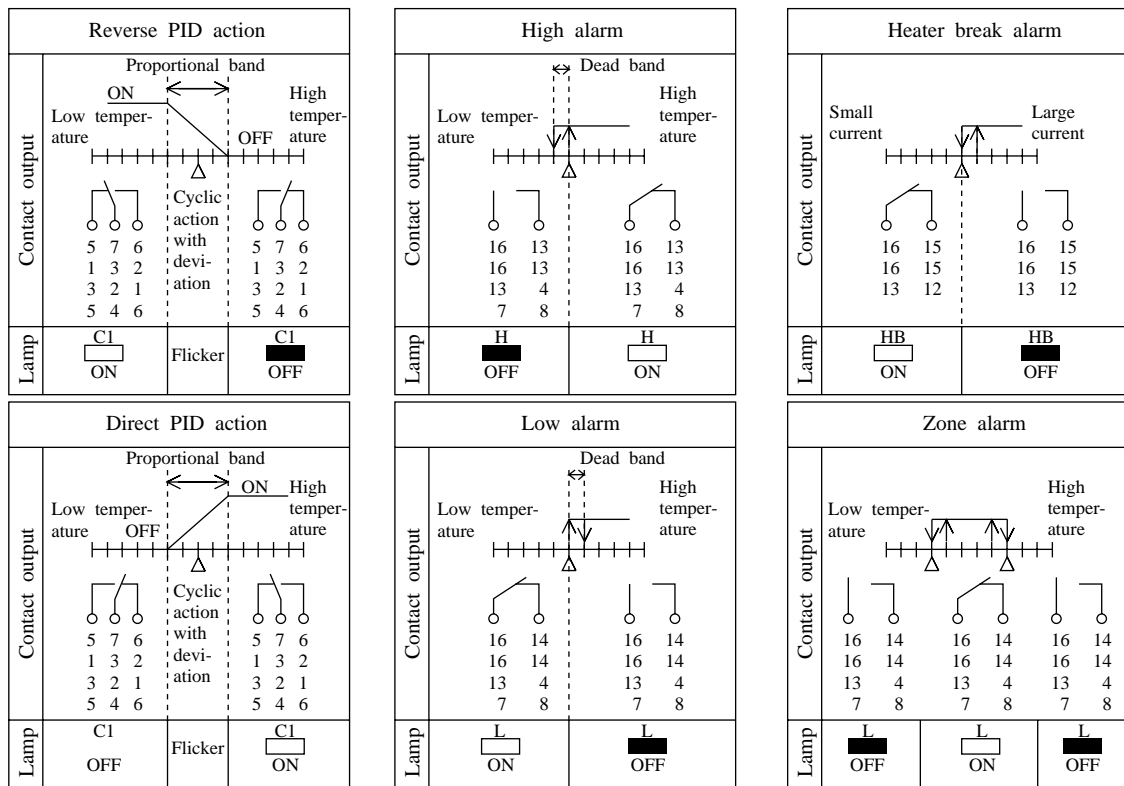

Fig. 9-1

- Output and indication during operation

(Note) Terminal No. varies with type of instrument.

Terminal No.:

Uppermost PYZ5, 9

Upper PYZ7

Lowermost PYZ4□□□□-0□

 PYZ4□□□□-1□

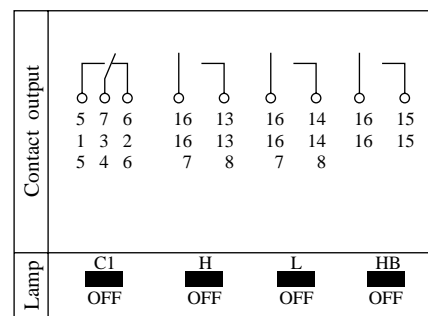
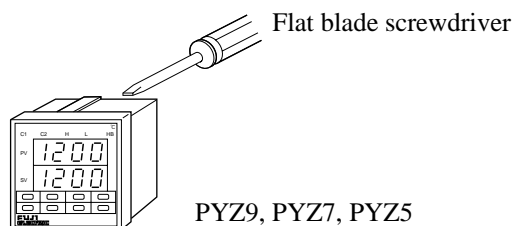

Fig. 9-2

10. CAUTIONS FOR INSTALLATION AND WIRING

○ Installation

- For front panel size of the instrument and the panel mounting size conform to DIN43700 Standards.
- Recommended panel of PYZ9, PYZ7 and PYZ5 is 1 to 8mm thick and the recommended panel of PYZ4 is 1 to 3.2mm thick.
- For installation of PYZ9, PYZ7 and PYZ5, attach the mounting brackets (two) on the top and bottom and tighten with a flat blade screwdriver to the torque of about 1.5 kg•cm.
(Plastic case is used. Do not tighten excessively.)



(Horizontal tight mounting)

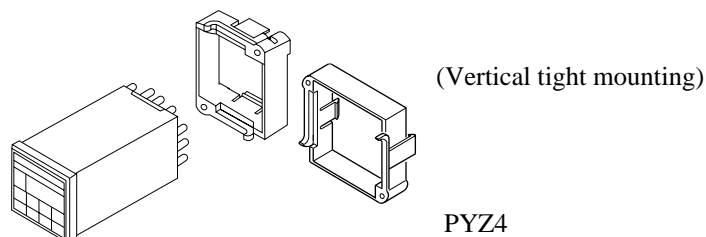

- For installation of PYZ4, insert the supplied panel frame from the rear side and secure it firmly until the main unit is fitted to the panel. When it cannot be fitted firmly, tighten the two screws lightly. (If the screws are tightened excessively, the frame may slip off the stopper.)

○ Environment of installation location

- Do not install in a place with corrosive gases (sulfuric gas, ammonia, etc.)
- Do not install in a place subject to vibration, impact, water or high temperature.
- Do not install in a place where ambient temperature changes suddenly or radiation from furnace is present. Ambient temperature of installation location should be -10 to +50°C.

○ Wiring

- This controller is not equipped with a power switch and fuse. These should be mounted if necessary (fuse rating: 250V, 1A).
- For thermocouple input, connect the specified compensating lead wire.
- For resistance bulb input, use a lead wire having a small resistance.
- Input signal and power cables connected to the instrument should be wired away from power line and load line to minimize inductive noise.
- For instrument with heater break alarm, use the same power source for the heater and the controller to minimize the variation of alarm operating point due to power voltage.

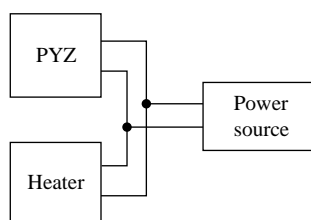

- Input signal cable should be separated from the output signal cable. Be sure to use shielded cables.

○ Use of controller output for sequence circuit

- When power is ON, it takes about 4 to 5 seconds until the internal relay starts operating. This should be taken into account when using the controller contact output for the sequence circuit.

○ Wiring of load circuit

- A load connected to the control output should be used within the rating. If it exceeds the rating, it should be connected through a contactor having a larger rating.

The contact output type has its own operating life so the control cycle (TC and TC2) should be extended so as not to affect the control function. In the case of the 2-position control, the hysteresis width should be increased making sure that it does not affect the control function. Also, care should be taken with regard to the alarm output and heater break alarm output when using.

- When the controller is used for frequent operation such as for proportional action, use SSR or SSC output type auxiliary relay, because if a load corresponding to the full capacity of output relay is connected, the life of it is shortened.

Electromagnetic relay:

Proportional cycle is more than 30 sec.

SSC, SSR:

Proportional cycle is more than 1 sec.

Contact output life:

Mechanical More than 10^7 cycles (at no load)

Electrical More than 10^5 cycles (at 220V AC/3A, resistive load)

○ Current output ripple

- Current output (4 to 20mA DC) contains about 0.2mA/2 Hz of ripples.

○ Removal of noise

- The instrument should be installed as far as away possible from a device generating high frequency noise.

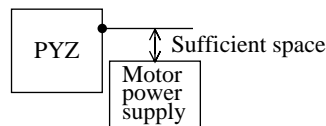

- Input signal and power cables connected to the instrument should be wired away from power line and load line to minimize inductive noise.

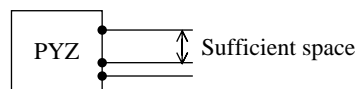

- Instrument power cable should preferably be twisted to avoid noise.

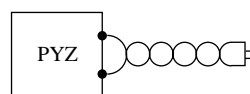

- When much noise is generated from external wiring, use the following preventive measure.
- When a contactor is connected as a load for digital output such as a relay contact or alarm output, use a surge absorber on the coil of the contactor.
Surge absorber Fuji Z-trap (ENB461D-14A, 220V AC)
- When much noise is generated from power supply, use an insulating transformer and a noise filter.
(Example: TDK ZMB22R5-11 Noise Filter)

- To protect relay output from ON/OFF surge and to ensure a long service life, we recommend you to use Fuji Z-trap.

Type: ENC241D-05A (100V AC)
ENC471D-05A (200V AC)

Mounting position: Connected between relay control output terminals

Example)

ATX2PSB

PYZ4

PYZ9

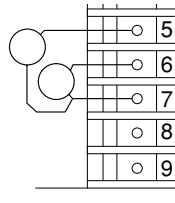
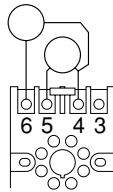

- Wiring for 4 to 20mA DC input
 - When ordering instrument of 4 to 20mA DC input specifications, a resistor (250 Ω) will be supplied as an accessory for connection to the input terminal.
 - When using the final control element in the non-insulated type, use the temperature sensor in non-grounding type.
- Wiring for 1 to 5V DC input
 - Use of the resistor (250 Ω) supplied for 4 to 20 mA DC input is not required.
- SSR/SSC drive output and 4 to 20 mA DC output are not isolated electrically from the internal circuit. Use a non-grounded type resistance bulb or thermocouple as a sensor.
- Connection of PYZ9, PYZ7 and PYZ5

For connection, use round type or fork type M3.5 clamping terminal. The maximum outside diameter of the terminal should be less than 8mm.

- Caution prior to use
 - To clean the front panel of the instrument, do not use benzine, thinner, etc., as it damages the panel. It should be washed with water or soapy water until the dirt and dust are removed. (The front panel of the instrument is water/dust-proof type based on IEC IP65 standards.)
 - Do not use any tool having a sharp tip when operating the keys on the front panel.

11. SPECIFICATIONS

Table 11-1

Input signal	Thermocouple/resistance bulb, 1 to 5V DC, 4 to 20mA DC
Control output signal	Contact (220V AC, 3A, 1c contact), 4 to 20mA DC (load resistance: less than 600Ω) SSR/SSC drive (24V DC typ./60mA at ON, 0.3V DC max. at OFF)
Control action	PID action (2-position action, proportional action possible)
Indicator accuracy	±0.5% FS ±1 digit (±5% FS ±1 digit : R, S thermocouple 0 to 400°C)
Operating cycle	0.5 sec.
Indication system	7-segment LED, 4 digits
Effect of external resistance	About 0.5 μV/Ω (Thermocouple input) Reading 0.015%/Ω (per wire), resistance bulb
Attachment	High/low alarm (PYZ4: high or low alarm) Alarm output: 220V AC, 1A, 1a contact, 2 points (PYZ4: 1 point) Heater break alarm (Contacted to separately installed Fuji's CT) Alarm output: 220V AC, 1A, 1a contact
Power supply	85 to 265V AC, 50/60Hz
Power consumption	About 10VA/100V AC, about 18VA/220V AC
Enclosure case	Plastic housing
Ambient temperature	-10 to +50°C
Ambient humidity	90% RH or less

Table 11-1 Input specification

Figure in () include those with decimal point.

Input	Range (°C)	Range (°F)	Remarks
Pt 100 (IEC)	0~50, …400 (0.0~100.0, …300.0) -150, …-100~50, …200 (-150.0, …-100.0~50.0, …200.0)	32~122, …752 -238, …-148~122, …392	Accuracy is not guaranteed when the range setting is below the minimum.
J	0~200, …1000 (0.0~200.0, …300.0)	32~392, …1832	
K	0~200, …1200 (0.0~200.0, …300.0)	32~392, …2192	Accuracy is not guaranteed when the reading is out of range.
R	0~1000, …1600	32~1832, …2912	
T	0~200, …400 (0.0~200.0, …300.0) -200, …-100~200, …400 (-199.9, …-100.0~200.0, …300.0)	32~392, …752 -328, …-148~392, …752	°F = $\frac{9}{5}$ °C + 32 (NBC standards)
N and PL-II	0~200, …1300 (0.0~200.0, …300.0)	32~392, …2372	
1~5V DC 4~20mA DC	-1999~3000 (Industrial value setting)		Setting of decimal point is possible.

Note) When the span of input range is large, the indication may be limited to 3276°F or 327.6°C in the over-range zone. Avoid a wide range setting unnecessarily.

12. ORDERING CODE

Table 12-1

1	2	3	4	5	6	7	8	9	10	digit	Description	
P	Y	Z					2					
											Front panel size	
											4	48×48mm
											5	48×96mm
											7	72×72mm
											9	96×96mm
												Input signal
											T	Thermocouple [°C]
											R	Thermocouple [°F]
											N	Resistance bulb, Pt100Ω, 3-wire (IEC) [°C] (*1)
											S	Resistance bulb, Pt100Ω, 3-wire (IEC) [°F] (*1)
											B	4 to 20 mA DC (*2)
											A	1 to 5V DC
												Control output 1
											A	Contact reverse action PID control
											B	Contact direct action PID control
											C	SSR or SSC drive reverse action PID control
											D	SSR or SSC drive direct action PID control
											E	4-20 mA DC reverse action PID control
											F	4-20 mA DC direct action PID control
												Control output 2 (Not for PYZ 4)
											Y	Without output 2
											A	Contact reverse action PID control
											B	Contact direct action PID control
											C	SSR or SSC drive reverse action PID control
											D	SSR or SSC drive direct action PID control
											E	4 to 20 mA DC reverse action PID control
											F	4 to 20 mA DC direct action PID control
												} Dual output
												Additional functions
											0	None
											1	With high/low alarm
											2	With heater break alarm (Note 2)
											3	With high/low alarm and heater break alarm (Note 2)
												Attaching socket
											Y	None (specifically when PYZ5, 7, 9 is used)
											A	With ATX2PSB (rear panel screw terminal)
											B	With ATXINS (US socket)
											C	With TP28S (rear panel screw terminal)
											D	With TP28X (rail mounting)
											E	With TP311SB (rear panel screw terminal)
											F	With 11GB (rear panel socket)
											G	With TP311SS (rear panel screw terminal)
											J	With TK7A5807P9 (front panel, rail mounting)

{
“PYZ4”
only
}

8-pin terminal (without alarm)
(for 9th digit code)

11-pin terminal (without alarm)
(for 9th digit code)

}

Note 1) Symbol for resistance bulb is as follows

Pt100 ----- IEC Pub. 751-1983

Note 2) The supplied resistor (250 Ω) should be connected to the terminal. (This resistor is not required for 1 to 5V DC input.)

Note 3) Heater break alarm is not available for PYZ4 and 4 to 20mA DC output.

Note 4) Specify control output 2 for dual output type.

Mounting socket ordering (PYZ4)

Type	Mounting	Application
ATX2PSB	Panel flush mounting	} For non alarm type
ATX1NS (US SOCKET)	Panel flush mounting	
TP28S	Wall mounting	
TP28X	Rail mounting	
TP311SB	Panel flush mounting	} For alarm type
11GB	Panel flush mounting	
TP311S	Wall mounting	
TK7A5807P9	Rail mounting	