

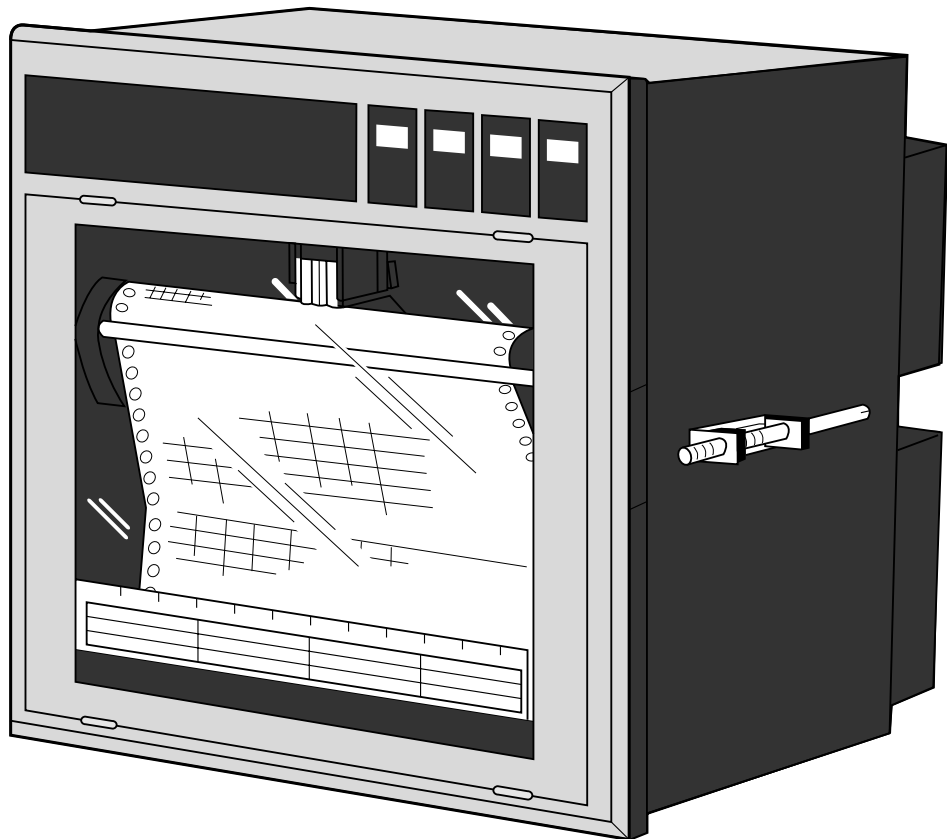

Instruction Manual

MICROJET RECORDER (24-point, 180mm)

TYPE: PHB



PREFACE

Congratulations on your purchase of Fuji Micro-jet Recorder (Type: PHB)

- Read this instruction manual carefully to ensure correct installation, operation and preparation. Incorrect handling may lead to accident or injury.
- Specifications of this unit is subject to change without prior notice for improvement.
- Modification of this unit without permission is strictly prohibited.
Fuji will not bear any responsibility for a trouble caused by such a modification.
- This instruction manual should be kept by the person who is actually using the unit.
- After reading the manual, be sure to keep it at a place easy to access.
- This instruction manual should be delivered to the end user without fail.

Manufacturer : Fuji Electric Instrumentation Co., Ltd.
Type : Shown on nameplate of Micro-jet recorder
Date of manufacture : Shown on nameplate of Micro-jet recorder
Product nationality : Japan

Request

- It is prohibited to transfer part or all of the manual without Fuji's permission.
- Description in this manual will be changed without prior notice.



© Fuji Electric Systems Co., Ltd. 2000

Issued in Dec., 2000



CAUTION ON SAFETY

First of all, read this "Caution on safety" before using the unit.

- The cautionary descriptions listed here contain important information about safety, so they should always be observed. Those safety precautions are ranked 2 levels, DANGER and CAUTION.

 DANGER	<p>Wrong handling may cause a dangerous situation, in which there is a risk of death or heavy injury.</p>
 CAUTION	<p>Wrong handling may invite a dangerous situation, in which there is a possibility of medium level trouble or slight injury or only physical damage is predictable.</p>
 PROHIBITION	<p>Items which must not be done are noted.</p>

Caution on Installation

 DANGER	<ul style="list-style-type: none"> • This unit is not an explosion-proof type. Do not use it in a place with explosive gases to prevent explosion, fire or other serious accident.
 CAUTION	<ul style="list-style-type: none"> • For installation, select a place observing the operating conditions noted in the instruction manual. Installation at an unsuited place may cause fall, trouble or malfunction. • The unit must be installed correctly as shown in the instruction manual. Incorrect installation may cause fall, trouble or malfunction. • During installation work, keep the inside of the unit free from entry of cable chips or other foreign objects as it may cause fire, trouble or malfunction.

 CAUTION	<p>This unit is a component device used for instrumentation. It is mounted on a panel or in a rack.</p> <ul style="list-style-type: none"> • The unit conforms to IEC1010-1 (1990) Safety Standards, and is designed for protection class I, overvoltage Category II and pollution degree 2, except the alarm output terminal (overvoltage category I). • EMC conforms to EN50081-1 (1992) and EN50082-1 (1992), (both used for housing areas), except that the noise level of the power terminal is rated for Class A (used for commercial and industrial areas). • Input signals and communication interface should be of SELV (safety separated from hazardous voltage).
--	--

Caution of Wiring



DANGER

- Wiring work must be performed as specified. If the unit is not earthed, it would result in electric shocks or malfunction.
- Be sure to connect power source that matches the rating. Connection of incorrect rating of power source may lead to fire.
- Before starting wiring work, be sure to turn OFF the main power to prevent electric shocks.
- Wiring materials to be used must meet the rating. Use of materials which do not withstand the rating may cause a fire accident.

Caution on Maintenance



DANGER

- When disposing of the recording head, put it in a vinyl bag and seal it to prevent the diffusion of ink. It should be handled as an incombustible object when disposing of it.
- Ink is harmful to human body. Observe the following emergency treatments.
 - When ink gets in eyes, wash out for at least 5 minutes immediately with much clean water, and ask your doctor for treatment at once.
 - When ink gets on skin, wash out and clean skins with soap and water.
 - When ink is breathed in, move to a clean place immediately. If necessary, ask your doctor for treatment at once.
- Do not touch the connector at the rear of the carriage mounting the recording head to avoid the risk of electric shocks.

Caution on Use



DANGER

- If the fault or anomaly of the device may cause serious accident or troubles to other devices, externally install appropriate protective circuit to avoid accidents.
- When fuse is blown out, check and remove the cause of it, and replace it with new one specified in the instruction manual. Do not use any other fuse or short it, as it may cause electric shocks or fire.

CONTENTS

PREFACE	i
CAUTION ON SAFETY	ii
1. INTRODUCTION	1-1
1.1 About the microjet recorder	1-1
1.2 Product check	1-1
1.3 Check on type and specification	1-2
2. NAMES AND FUNCTIONS OF PARTS	2-1
3. MOUNTING METHOD	3-1
3.1 Mounting location	3-1
3.2 External dimensions and panel cut out dimensions	3-1
3.3 Method of mounting onto panel	3-2
4. WIRING	4-1
4.1 Before doing the wiring	4-1
4.2 Connection of wires to terminals	4-1
5. SET-UP	5-1
5.1 Loading chart paper	5-1
5.2 Recording head installation (replacement)	5-4
5.3 Changing the type of input signals	5-9
6. OPERATION AND ACTIONS	6-1
6.1 Before running the equipment:	6-1
6.2 Power switch-on and states	6-2
6.3 Test pattern print-out	6-3
6.4 Actions during operation	6-3
6.5 Displays and print-outs on detection (cancellation) of alarms	6-5
6.6 Displays and print-outs on occurrence of burnt-out	6-5
6.7 Over-range, under-range display and abnormal input display	6-6
6.8 Display and record when chart paper runs out	6-6
6.9 Display and record when the recording head ink is low	6-6
6.10 Display when data backup batteries need to be replaced	6-7
6.11 Display of fault in recording head carriage	6-7
6.12 Order of priority of state displays	6-7
7. SETTING AND CHECKING PARAMETERS	7-1
7.1 Setting and checking	7-1
7.2 Outline of procedure for setting parameters	7-3
7.3 Pass code setting	7-4
7.4 Setting the chart speed	7-5
7.5 Setting alarms	7-7



Chapter 3, 4 and chapter 8 should be observed for installation and maintenance of the unit. So, it must be performed by qualified engineers.

7.6	Setting the recording mode	7-8
7.7	Setting record ranges	7-12
7.8	Setting kind of input, skip, unit, filter, scaling, subtraction	7-13
7.9	Setting Tag Nos.	7-19
7.10	Message print specification	7-20
7.11	List print-out specification	7-23
7.12	Daily report specification	7-24
7.13	Specifying totalize function	7-26
7.14	Setting the time	7-27
7.15	Clearing the ink monitor	7-28
7.16	Turning the chart illumination lamp on/off (option)	7-29
8.	MAINTENANCE - INSPECTION	8-1
9.	APPLICATION FUNCTIONS	9-1
9.1	Adjustment of backlash	9-1
9.2	Zero/span adjustment for analog trend recording position	9-2
9.3	Setting of alarm latch and integrated value print-out	9-3
9.4	Setting of PV shift	9-4
9.5	User definable unit	9-5
9.6	Setting of record error external output	9-6
9.7	Calibration of measured value	9-7
9.8	Change of record color	9-8
9.9	Language selection	9-8
10.	TROUBLESHOOTING	10-1
11.	EXAMPLES OF RECORDS AND PRINT-OUTS	11-1
11.1	Periodic print-outs, scale print-outs	11-1
11.2	Digital print-out (instantaneous values)	11-2
11.3	Parameter list print-out	11-3
11.4	Test pattern	11-3
11.5	Scale print-outs	11-3
11.6	Daily report print-out	11-4
11.7	Data sum list print-out	11-5
11.8	Message print (manual print)	11-5
11.9	Logging	11-6
11.10	Alarm print-outs	11-6
11.11	Burn-out print-out	11-6
11.12	Ink dry-up warning print-out	11-6
11.13	Record start mark	11-7
11.14	Chart speed change mark	11-7
11.15	Auto-range change mark	11-7
12.	SPECIFICATION	12-1

1. INTRODUCTION

Before using the Micro-jet recorder, read this manual carefully as it describes its installation, operation, maintenance, etc.

1.1 About the microjet recorder

- (1) This recorder is a multirange input recorder 180mm wide which can record up to a maximum of 24 points using thermocouler/resistance bulb and DC voltage input signals.
- (2) It effects high-speed recording and gives clear analog trend records and digital print-outs in 6 colors.
- (3) As well as providing records of measurement values, the standard unit has a wide range of print-out functions comprising, e.g., the print-out of dates, chart speed, measurement ranges, Tag Nos., daily reports and integrated totals.
- (4) Operation of the equipment is simple thanks to an easy-view display section which permits key-in of various items of set data.

1.2 Product check

Check on accessories.

The unit comes with the accessories shown in Fig. 1-1. Please check that they are all there.

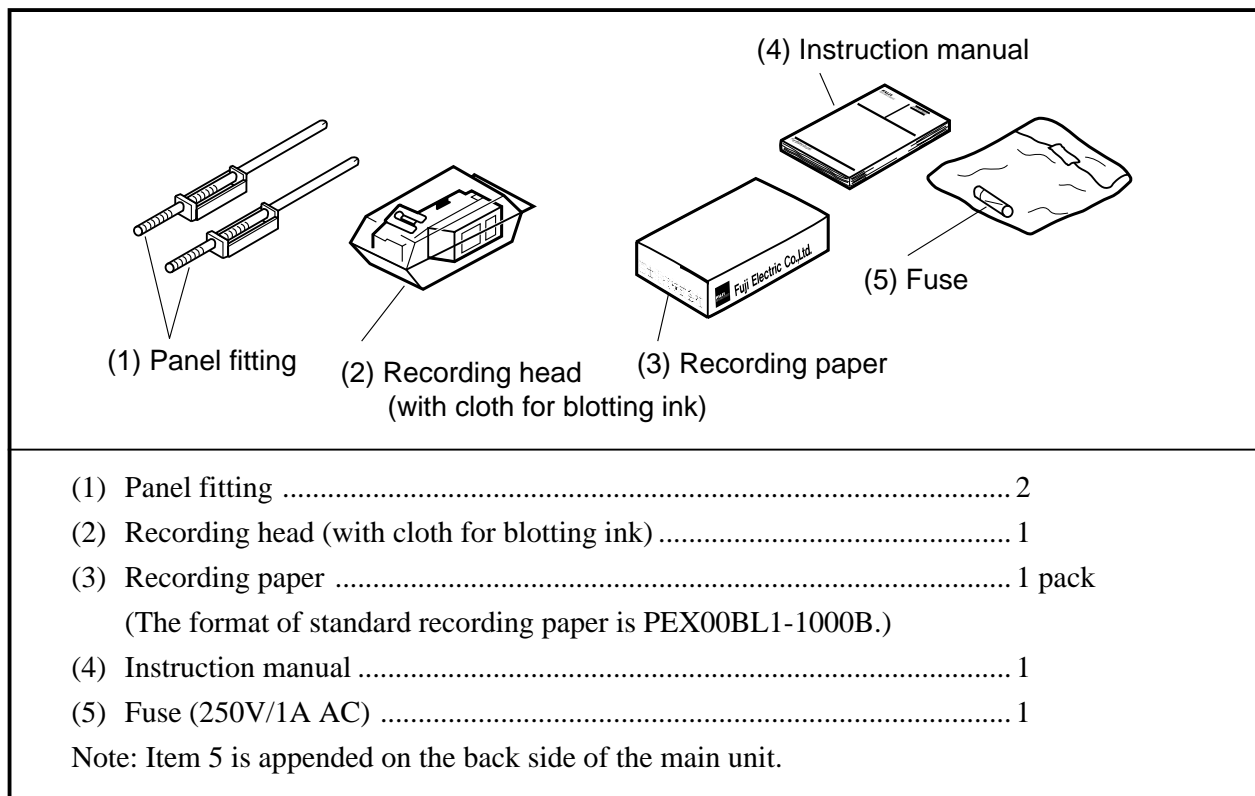

Fig. 1-1 Accessories

1.3 Check on type and specification

The data plates note the type name, etc. Please check to see that you have got a unit with the specification you ordered. (There are data plates on the top surface of the case and in the main unit.)

1 2 3 4 5 6 7 8 9 10 11 12 13 places															
P	H	B	1				1	-	E		Y	V/Y	Meaning		
			1											Number of recording points 1 continuous record	
			0											Number of input signal points (thermocouples)	The total number of points must be equal to the number of points in place 4.
			6												
			8												
			A												
			B												
			Z											Number of input signal points (resistance bulbs)	
			0												
			6												
			8												
			A												
			B											Number of input signal points (DC voltage)	
			Z												
			0												
			6												
			8												
			A											Chart illumination*	
			B												
									A				Alarm output/external control*		
									B						
									0				Communication		
									1						
									2						
									Y				None		

- Ex-works values of input signals
Thermocouple: K 0 to 1200°C
Resistance bulbs: Pt 100 0 to 500°C
DC voltage: -5 to +5V DC

- Relations between input signal specifications and recording channels

Ex.: If 6 thermocouple points, 12 resistance bulb points and 6 DC voltage points are specified.
Channels 1 to 6 are thermocouple
Channels 7 to 18 are resistance bulbs.
Channels 19 to 24 are DC voltage.

Asterisks * indicate options.

Note: The "Z" in places 5, 6 and 7 indicates a non-standard specification. Please check by the positions of the input signal type setting pins indicated in Section 5.3.

Note: After purchasing the unit, the type of input signal can be changed within the number of the record pins (See Item 5.3).

- Supplementary supplies

Product name	Type	Specification	Sales units
Recording head	PHZH1002	1 per unit	1
Recording paper	PEX00BL1-1000B	Approximately 20m (6 packs/box)	6 packs

2. NAMES AND FUNCTIONS OF PARTS

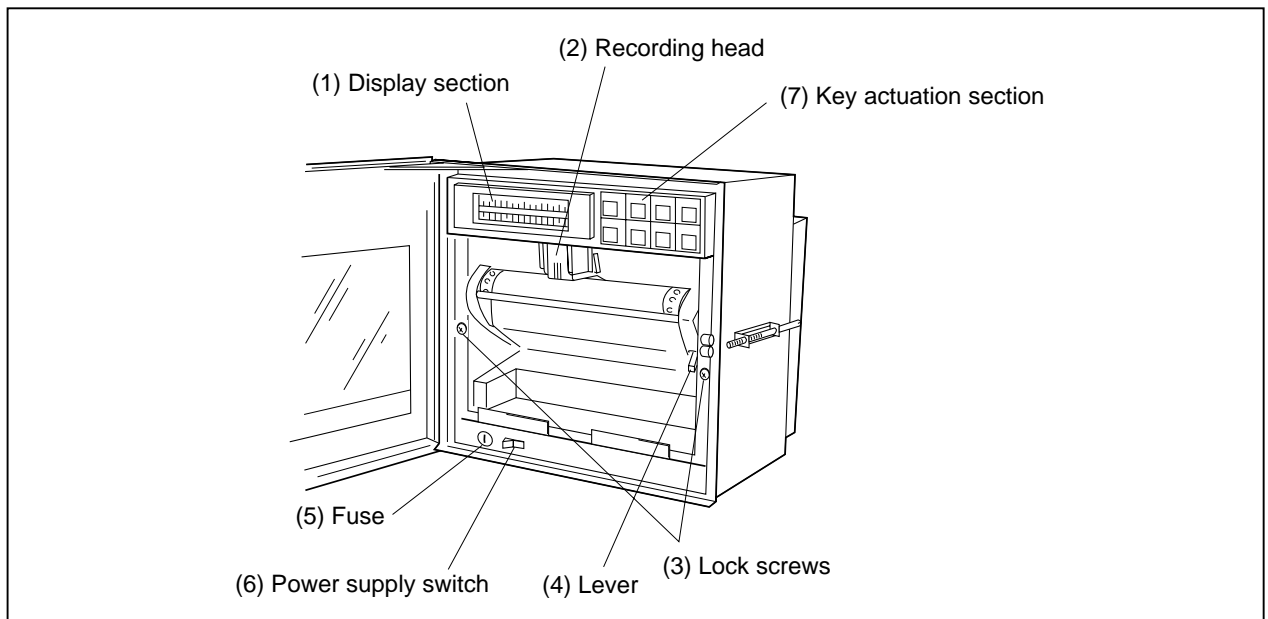

(1) Display section

For displays such as measurement data, units and displays of various parameters and comments display of units and data for each channel display of various parameters, comments

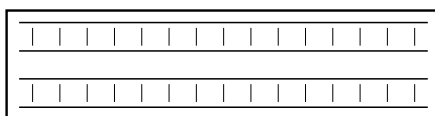

← display of units and data for each channel

← display of various parameters, comments

(2) Recording head

This is a recording head which serves for analog trend recording and digital print-outs. **As this is not installed in the main unit at the time of delivery, please install it referring to Section 5.2.**

(3) Lock screws

To change the type of input signals, remove the lock screws on the left and right, detach the main unit and make changes inside the instrument (replace the input signal setting pins).

Note that changes in the type of thermocouple can be effected by front panel key operations.

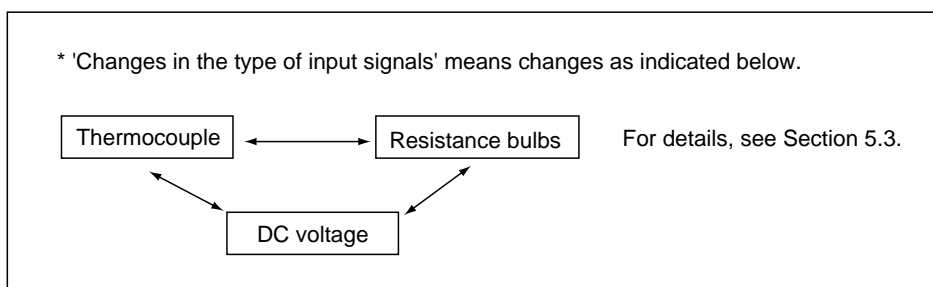

However, change to the thermocouple model or switching between new JIS and old JIS for resistance bulb can be performed by key operation on the front face.

(4) Lever

This is a lock lever for opening and closing the recording paper holder.

(5) Fuse holder

The holder contains a 250V/1A AC power supply fuse.



(6) Power supply switch

Used to turn on and off the power.

(7) Keying operation section

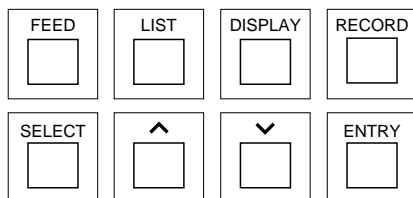
This is used for setting various parameters, making checks and running the equipment.



Name of key	Function
FEED	The speed is 3mm/sec during the first second that the key is held depressed and goes to 8mm/sec after the elapse of 1 second.
LIST	This is used for effecting print-out of data (instantaneous values). If you wish to stop the print-out partway through, press the key again. The recording paper fast feed key. This key is always valid.
DISPLAY	1. This is used for changing the contents of displays. Successively pressing the key and releasing it brings about the following 5 changeovers. (1) Sequential display of the data of all channels. However, there is no display for skip channels. The data display is updated once every 3 seconds. (2) Display only of the data of specific channels. The data display is updated once every second. (3) No 1 to 6 channels are display simultaneously, and data display is updated at 1 second intervals. (4) 7 - 12 channels are displayed simultaneously. (This panel is not displayed when the number of recorded points is up to six.) Data display is updated once every second. (5) Display of the data and time. 2. This key is used for shifting from a set mode to the data display mode. This key is ineffective during print-out of data or lists.
RECORD	Operation key for starting and stopping recording. Recording starts when the key is pressed once and stops when the key is pressed again. This key is ineffective during print-out of data or lists.
SELECT	1. Used for shifting from the data display mode to a set mode. 2. Is used for effecting sequential read-out of parameters during operation in a set mode. This key is ineffective during print-out of data or lists.
  (up) (down)	Used to scroll numerical values up and down. The values are scrolled up or down 1 count each time the relevant key is pressed. Holding a key depressed for more than 0.5 seconds results in a fast up/down scroll at a rate of 5 counts/second and holding it depressed for a further 2 seconds results in an ultra-fast scroll of 55 counts/second.
ENTRY	Is used to register set data. This key is effective only during set mode operation.

Special keying operations

Press  key while pressing the FEED key.	Used for reversing the recording paper feeding direction. (However, continuous feed is permitted up to about 25 mm.)
--	---

3. MOUNTING METHOD

This unit is designed to be panel mounted.

3.1 Mounting location

Select the following location for mounting the unit.

- (1) A place that is not subject to vibration or impact.
- (2) A place where there is no corrosive gas.
- (3) A place that is subject to little temperature variation and is close to normal temperature (23°C)
- (4) A place that is not struck directly by strong radiant heat.
- (5) As humidity affects the ink and recording paper, select a place that is in the range 45 to 80% RH.
- (6) Mount the unit horizontally, with no tilt to the left or right.
(The forward tilt should be 0 (but the unit may be inclined 0 to 30° rearwards.)

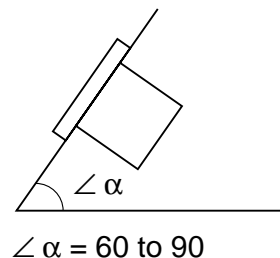

3.2 External dimensions and panel cut out dimensions (unit: mm)

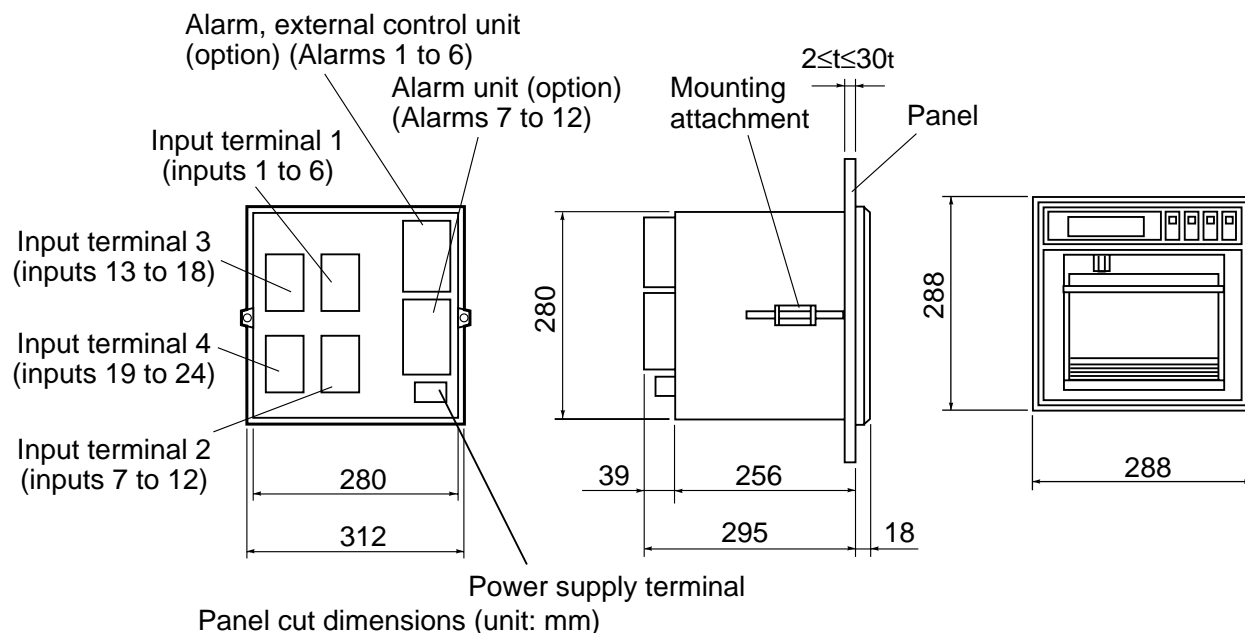

Mass: Approximately 9.6kg (without options)
Approximately 10.5kg (with all options)

Power consumption: Approximately 0VA
(100V AC without options)
Approximately 0VA
(100V AC with all options)

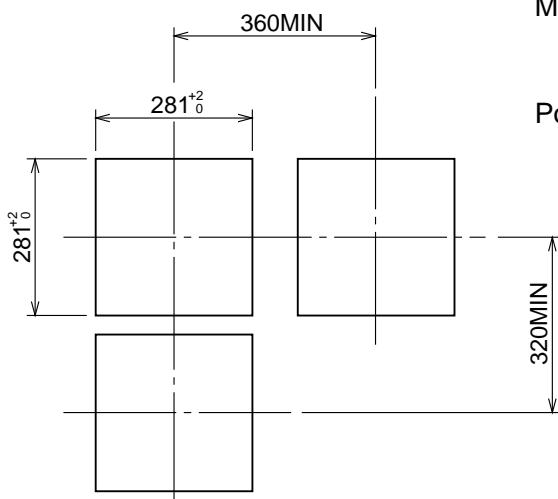

3.3 Method of mounting onto panel

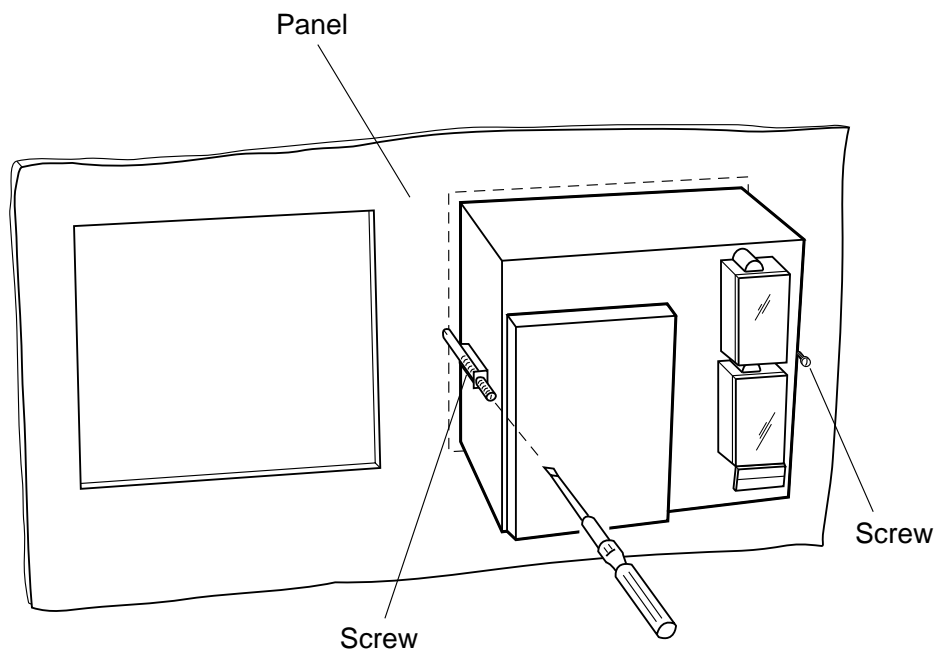

- Tighten and fix the mounting screw attachments on the left and right.
- Use a panel that is 2mm or more thick.

4. WIRING

4.1 Before doing the wiring

To carry out wiring, remove the unit's rear cover (Notes).

- (1) For the power cable, use a 600V vinyl-insulated cable (JIS C 3307) or a cable with equal or superior performance to this.
- (2) Use compensating leads for thermocouple inputs.
- (3) To avoid the effects of induction noise, keep input signal leads as far away as possible (at least 30cm) from power supply lines and lines carrying heavy current. Also, wherever possible use a shielded cable and earth one point of the shield.
- (4) For wiring the terminals, use a maximum of 2 crimp style terminals.

Notes

- (1) To remove the rear cover, put a finger in a cable through-hole in the cover, gently raise the cover and then pull outwards.
- (2) After wiring up the input terminals, always replace the rear cover in its original position so as to ensure proper compensation of reference contacts for thermocouple inputs.
- (3) We recommend the use of insulation-sleeve solderless terminals (using M4 thread) for connecting wires to terminals.

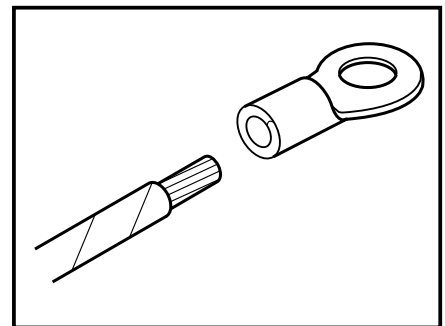

4.2 Connection of wires to terminals

- (1) Input terminals
 - ⇨ Connect signal leads for each channel.
- (2) Alarm, external control unit (option)
 - ⇨ Connect the alarm signal outputs and external control signal inputs (for alarms 1 to 6, external controls 1 to 3).
- (3) Alarm unit (option)
 - ⇨ Connect the alarm signal outputs (for alarms 7 to 12).
- (4) Power supply terminal
 - ⇨ Connect the power cables to AC/AC terminals. Connect to a noise-free, stabilized power supply.

This is an 100 to 240V AC free power supply.

- (5) Ground terminal ⇨ Effect type 3, Grounding (not more than 100Ω) of the G terminal.

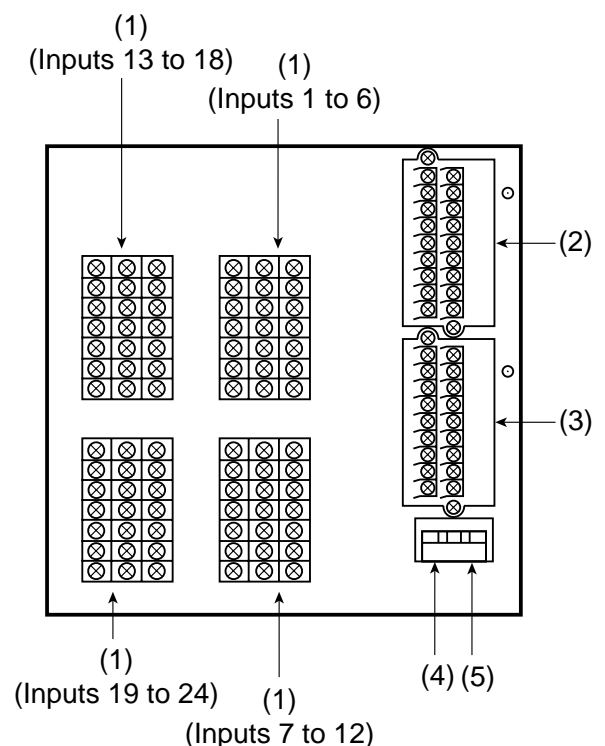

Alarm unit are of overvoltage category I.

Other signal (input, communication interface) should be SELV (safety separated from hazardous voltage).

(1) Wiring of input terminals

- (1) There are individual input terminal numbers for different channels.
- (2) Make connection in accordance with the relation between number of input signals by type designation and channels (see section 1.3).
- (3) If you decide to change the type of input signals after your purchase, be sure to remember to wire up the requisite channel accordingly.

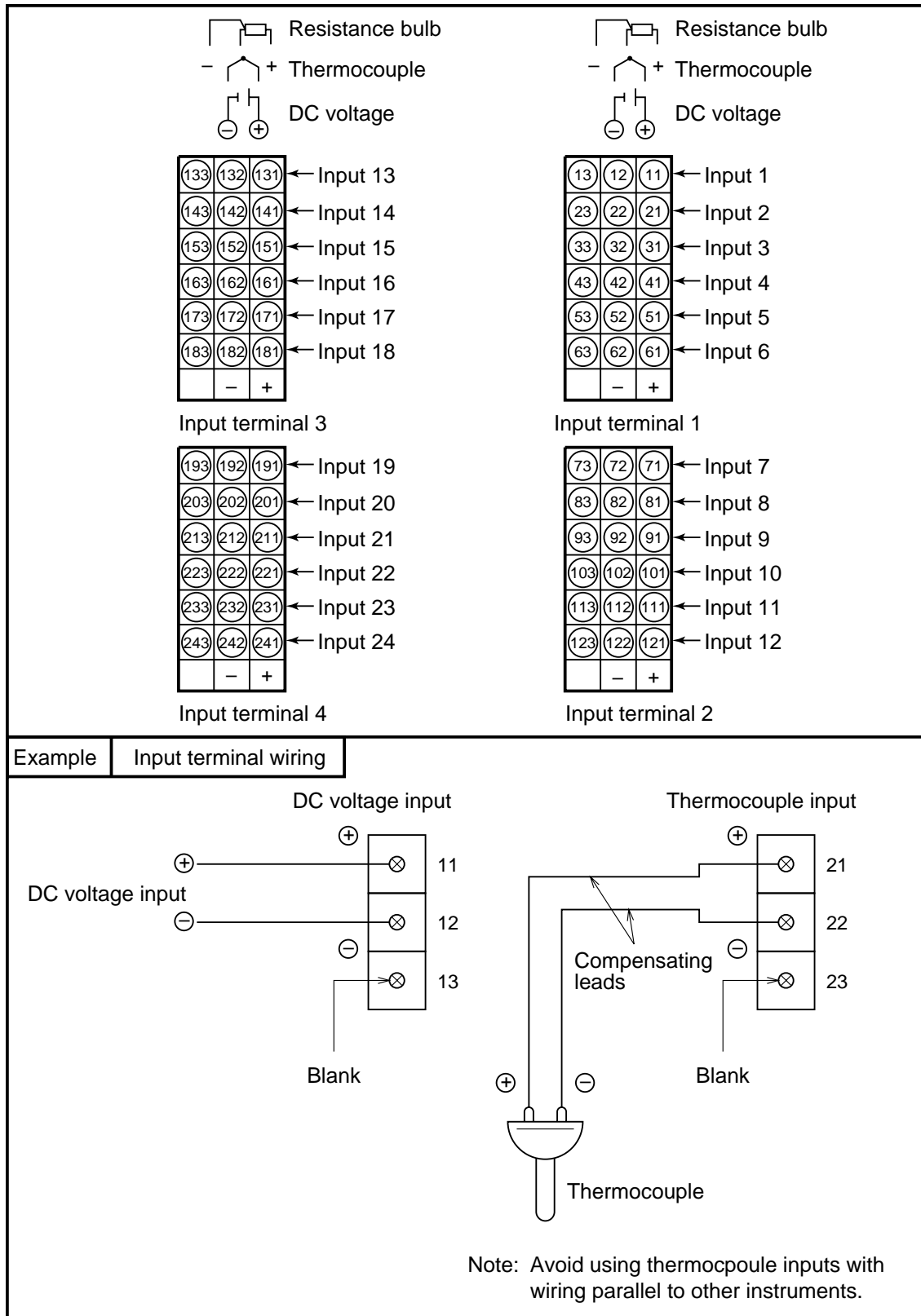

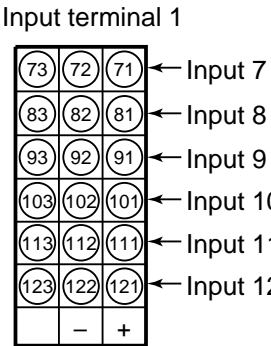
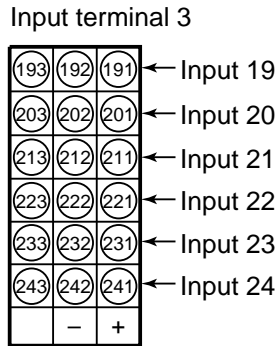
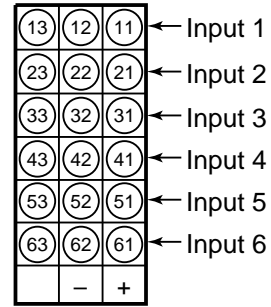
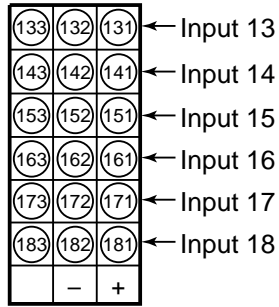
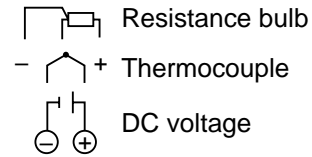
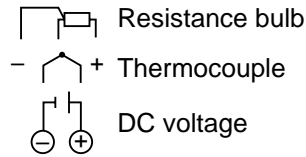

Example Input terminal wiring

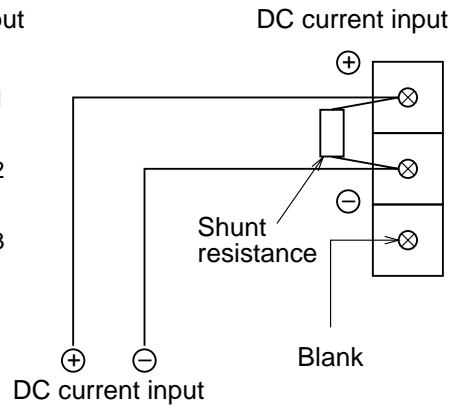
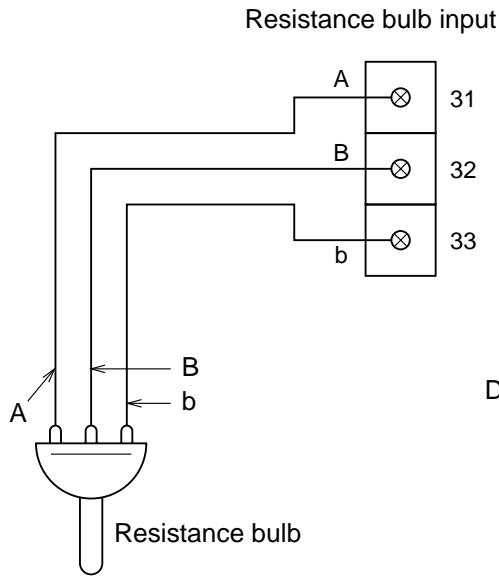

Example: A $10\Omega \pm 0.1\%$ shunt resistance is used for 4 to 20mA, 10–50mA input.

[In this case, $\pm 500\text{mV}$ input range is available. See Section 5-3.]

Note: DC current input is converted into voltage by shunt resistor (10Ω):

In 4 to 20mA DC : 40 to 200mV DC range
 In 10 to 50mA DC : 100 to 500mV DC range

(2) Alarm output/remote control unit (option)

About alarm outputs :

- (1) Alarms can be set at 4 points in each channel and alarm outputs are provided as an option for up to a maximum of 12 points.
- (2) When an alarm is detected, the relevant terminals are shorted.

Relay contact capacity 240V/3A AC, 30V/3A DC (resistive load), 1a contact

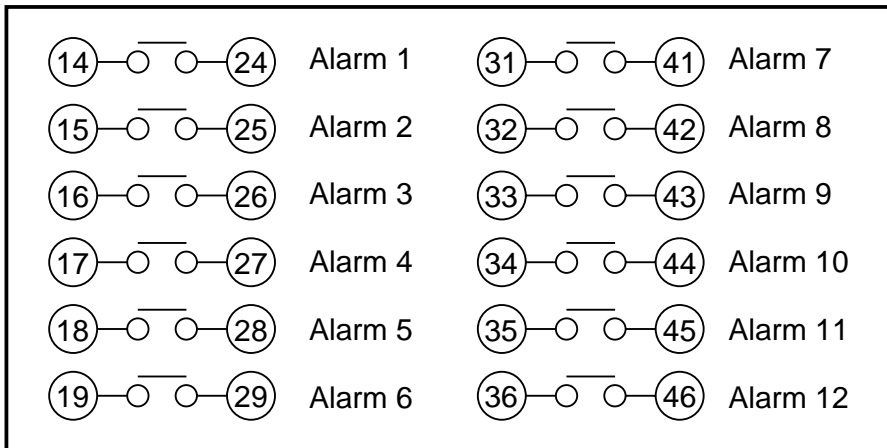

Note: If lamps are used on the outside, insert a resistor to prevent surge current. Also, if relays or solenoids are used, insert elements for contact protection (diodes, surge killers, etc.)

About remote control inputs

- (1) This performs the functions 'Recording operation start/stop', 'Two-stage changeover of recording paper speed' and 'Data (instantaneous value) print-out' in response to contact signals from outside the instrument.
- (2) There are separate wiring terminals for the different functions.

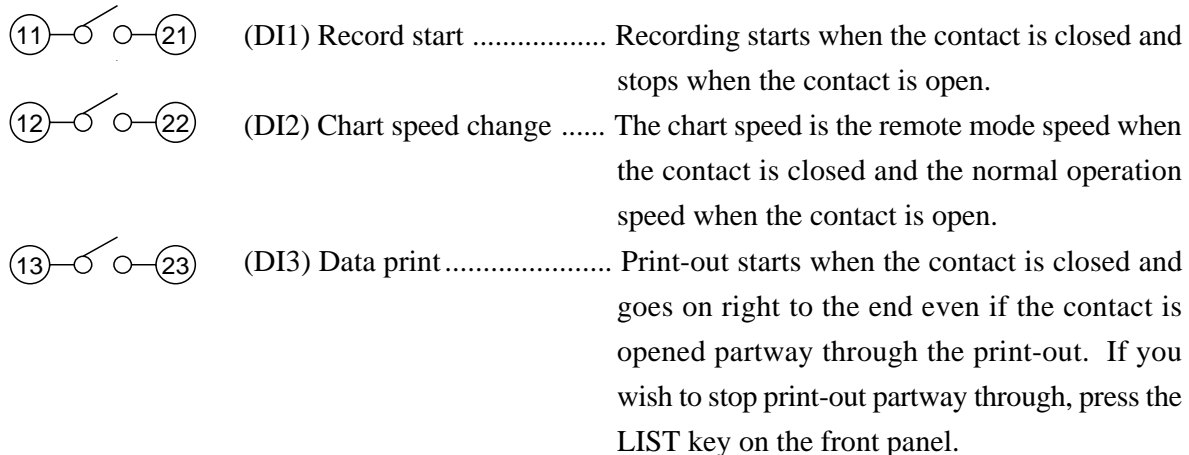

Note 1: As the external control unit is not insulated, use it with interposition of an external relay.

External contact capacity 12V DC/0.05A 1a contact

Note 2: Operations effects by the external control unit and the front panel switches are as in the table below. (A - in a box of the table indicates that no effect at all is had on the main unit operation.)

Note 3: When using the message print function or alarm latch function, the meaning of control input is different. Refer to "7.10 List print-out setting" and "9.3 Alarm latch specification".

	Remote control						Front panel switch	
	Recording starts (across terminals (11) to (21))		Chart speed change (across terminals (12) to (22))		Data printout (across terminals (13) to (23))		RECORD	LIST
	ON	OFF	ON	OFF	ON	OFF		
While recording is stopped	Recording starts	—	—	—	List printout starts	—	Recording starts	List printout starts
During recording	—	Recording stops	Remote mode chart speed	Normal operation chart speed	List printout starts	—	Recording starts	List printout starts
List printout	Recording starts	—	—	—	—	—	—	List printout stops

(3) Caution on connection of input signal through barrier

A) Thermocouple input and resistance bulb input

Perform "Calibration of measured value" with the input connected to the barrier recorder because the barrier internal resistance is added and causes an error in the measured value.

For the calibration method, refer to Item 9.4.

B) When using Fuji Zener Barrier (PWZ), a power source 100V AC line (85 to 132V AC) should be used to ensure safe operation of the unit.

5. SET-UP

5.1 Loading chart paper

Step 1

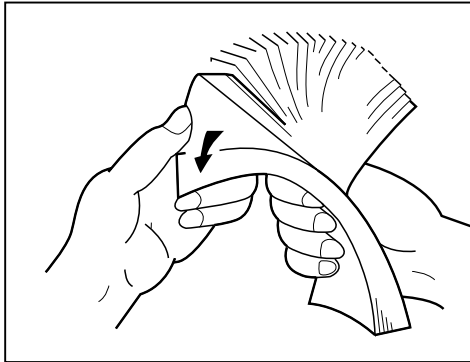

Riffle and loosen the recording paper so as to prevent overlapping feed.

Step 2

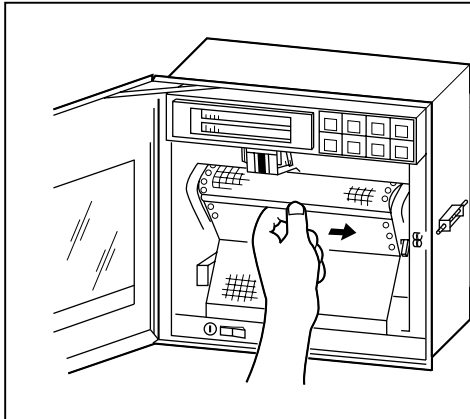

Open the front flap, push the paper hold-down roller to the right and detach it.

(To replace chart paper while recording is in progress, carry out the above after pressing the **RECORD** key to stop recording.)

Step 3

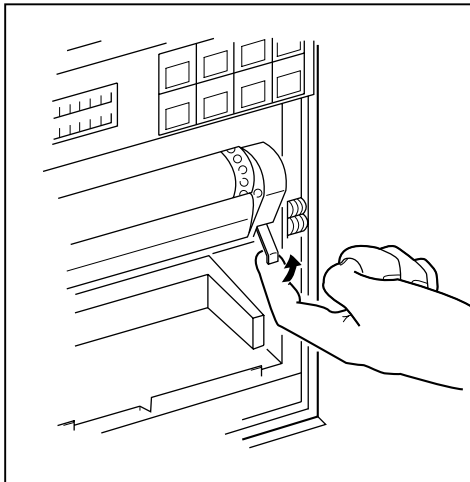

Raise the lever that is on the right.
This releases the lock, the paper feeder moves downward and paper holder can be seen.

Step 4

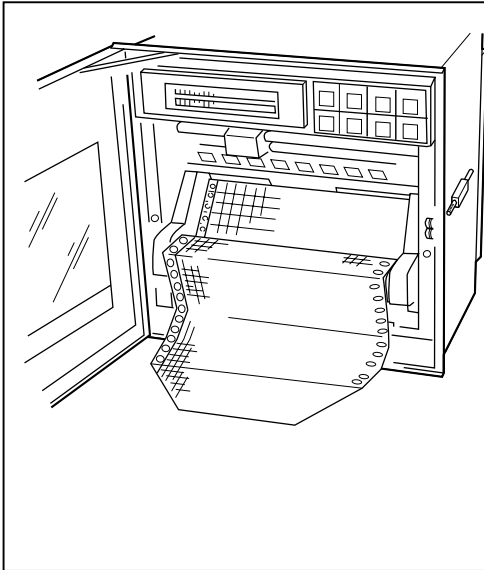

With round holes (small holes) in the recording paper located on the left-hand side, set the recording paper so that its leading edge with both corners cut off comes to this side. Then insert the leading edge into the container with the printing face located upward.

Butt the recording paper to the left-hand end and set the recording paper in this position at this time. Furthermore, be careful so that the recording paper will not be located aslant. In addition, **droop the first two or three folds of the recording paper into the recording paper receiver.**

Step 5

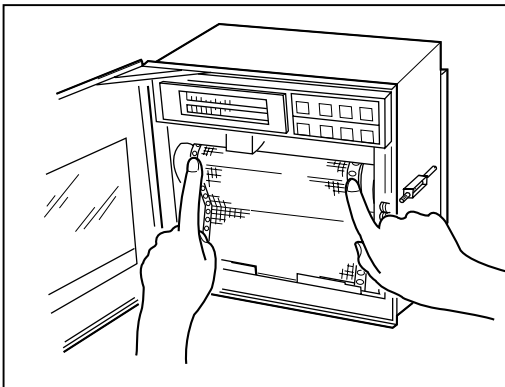

Press the chart paper so that its holes engage with the sprockets and then, without further adjustment, return the paper holder to its original place.

Make sure that the chart paper does not lift up.

Note: If chart paper lifts up and contacts the recording head, it can prevent ink coming out. It can also cause improper paper feed.

Step 6

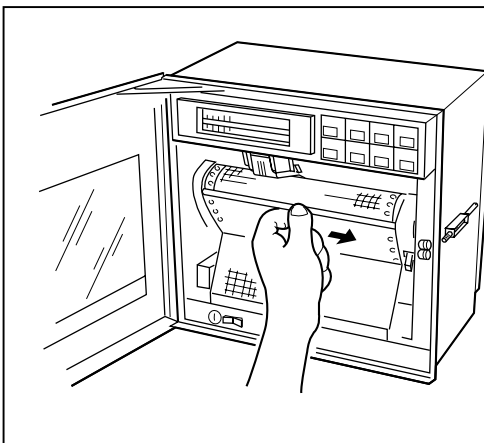

Return the paper hold-down roller to its original position.

Check to make sure that the chart paper is straight and that its holes are properly engaged with the sprockets.

In order to prevent the chart paper slipping to the left or right, **position equipment so that the paper folds into the middle of the paper catcher.**

Turn the power supply switch on.

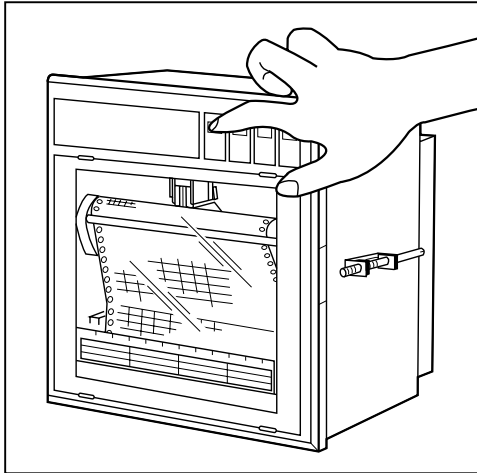
Step 7

Press the **FEED** key and check that the chart paper is fed out smoothly. (Feed out about 2 folds of paper.)

<If the paper is not fed out smoothly, go through the procedure from Step 2 again.>

Note 1: Selection of chart paper

The chart paper greatly affects the quality of the printed recording and it is also related to problems such as paper jamming, etc.

Please be sure to use the pure-quality chart paper specified by us.

Chart paper type: PEX00BL1-1000B (100 equal divisions, no time lines)

Note 2: Use of the recorder after it has been left unused for a long time

If the recorder is left unused for a long time with chart paper still in the main unit, the paper 'packs down' and if the recorder is used straightway there can be problems of paper jamming, etc.

If you use the equipment after it has been left unused for a long time, first press the **FEED** key to feed out 2 to 3 folds of the paper.

Reference 1: Chart paper length

The chart paper is approximately 20m long. This permits about 31 days continuous print-out at a paper feed speed of 25mm/h.

Reference 2: Chart paper end mark

The amount of chart paper remaining is indicated by digits (units : cm) on the right-hand side of the paper. When there is only a small amount left, red letters appear on the right-hand edge.

If the recording paper runs out completely, a recording paper end indicator displays 'Chart end' in the display section and recording automatically stops.

5.2 Recording head installation (replacement)

The recording head has ink and a head for recording in an integral assembly.

If the ink gets used up or if it happens that there is a fault, the head can easily be replaced.

As the recording head is a very delicate element, please carefully read the 'Precautions' that are noted later and handle the head with care during replacement work.

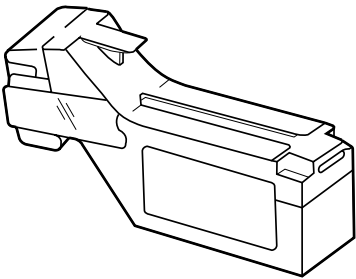
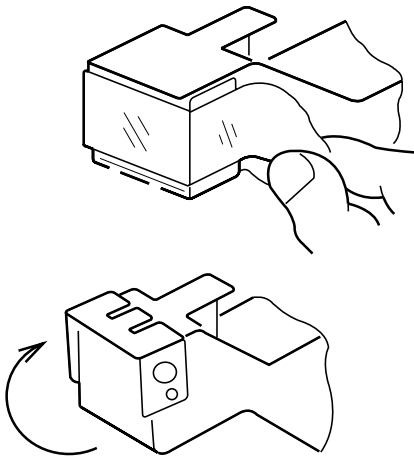
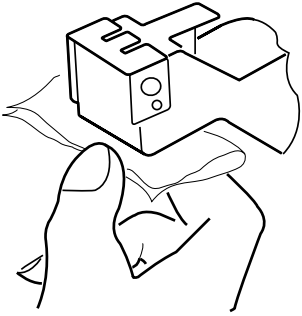
Step 1		Get the recording head ready by taking it out of its aluminium pack.
Step 2		Tear the tape. Open the cap by turning it in the direction indicated by the arrow. (If the head is not going to be used for a long time, close the cap back in its original position.) The cap is integral with the head unit. Turn it about 180° until it stops against the top of the head.
Step 3		Lightly press the nozzle surface (the surface from which ink is discharge). Make sure that the cloth is properly impregnated with the 4 colors blue, red, yellow and black. (First press the cloth against the surface for 2 to 3 second; if the 4 colors ooze out, it is OK.)

How to close the cap

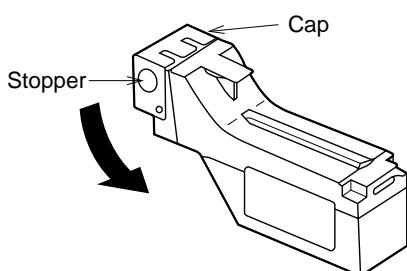

- Turn the cap in the direction indicated by the arrow and press it firmly until it is retained by the stopper.
- Ink may leak out if the cap is not properly in place.

Step 4

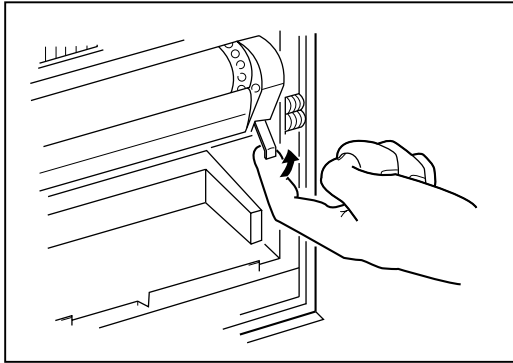

- If recording is in progress, stop it by pressing the RECORD key.
- Raise the lever that is on the right. This releases the lock comma only, the recording paper feed section pulls forward and a recording paper holder can be seen.

Step 5

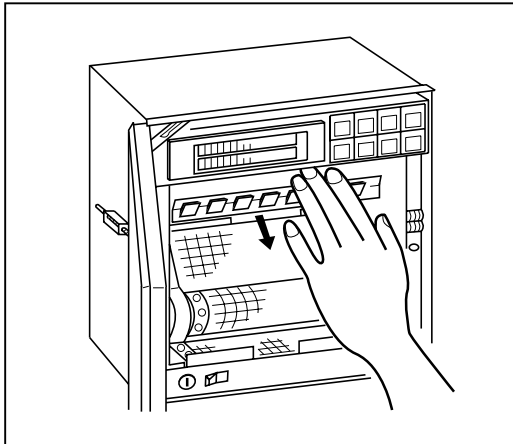

Push the chart paper hold-down plate spring down.

Step 6

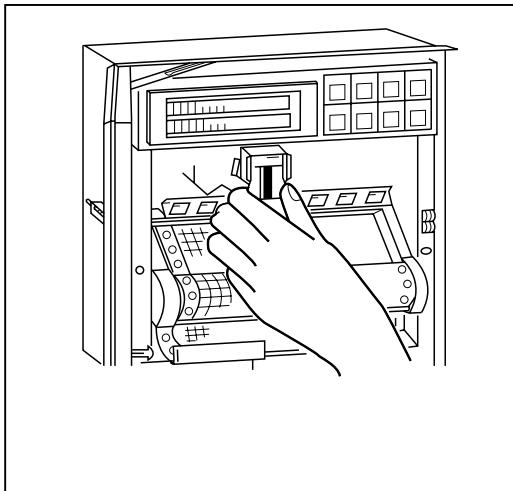

Hold the recording head horizontal, **line it up with the carriage in the main unit** slide it in slowly and press it firmly until it does not go in any further. Take care not to bang the nozzle surface of the hand.

Also, avoid touching the nozzle surface with your hand.

CAUTION

Do not touch the connector at the rear of the carriage to avoid the risk of minor electric shocks.

Step 7

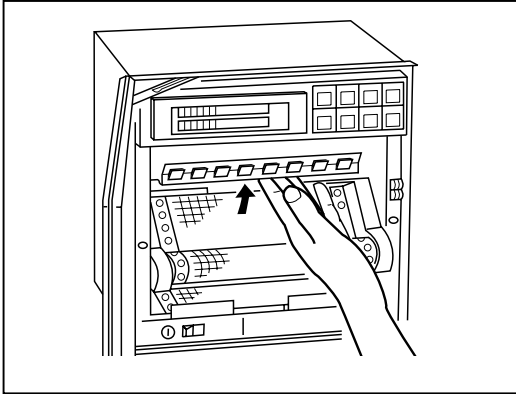

Move the chart paper hold-down plate spring back up to its original position.
(Check that the plate spring is not contacting the recording head.)

Step 8

Return the chart paper holder to its original setting.

The above completes installation of the recording head.

The recording head is a consumable part. Replace it with a new one when the ink it contains is used up.

Recording head replacement

Draw out the recording head in the manner that is opposite to what is described in **Step 6** of the recording head setting procedure, and place it with a new recording head.

Always carry out the following procedure after replacing a recording head.

(1) Setting the ink monitor

Perform the following keying actions in order to get correct performance of the ink dry-up warning-detection function.

As in "Clearing the ink monitor" of Section 7.16, press the **SELECT** key to give an "Ink monitor clear" display.

INK MONITOR CLEAR
NO



INK MONITOR CLEAR
YES

Press the  key to change the flickering "NO" to "YES".

Next, press ENTRY the **ENTRY** key.

This completes the setting.

Press the **DISPLAY** key to return to a data display

(2) Test patten print-out

Print out a test pattern to check that normal recording is possible. Set Section 6.3 for the way of printing out a test pattern.

(3) Adjustment of analog trend recording positions

Referring to Section 9.2, readjust the zero and span on the recording paper.

Precautions in handling recording heads

Note 1: If recording is halted and the recorder is not used for a long time

Carry out the following in order to prevent jamming and drying-up of the ink.

Remove the recording head from the main unit, make absolutely sure the cap is closed properly and store the head in a cool, dark place (average temperature 5 to 30°C).

If the head is left installed in the recorder:

Do not switch off the power to the recorder and do not close the cap.

*** Periodically, there is an automatic discharge of ink to prevent drying-up.**

Leave the recording paper in place in the recorder.

If it is not possible to keep the power switched on, make sure that the cap is closed.

In this case, follow (Step 4) and (Step 5) of 'Recording head installation' to lower the recording paper holder and hold-down plate spring and tighten the cap.

Note 2: At the start of use of a recording head

If you are starting to use a new recording head or if the recorder has been left unused for a long time, always wipe the head's nozzle surface lightly with the accessory cloth and check that the 4 colors black, blue, red and yellow ooze out properly into the cloth. (See Section 5.2.) Also, after normal recording is possible. See Section 6.3 for the way of printing out a test pattern.

When the working environment is 15°C or less, perform print-out of "test pattern" after period of several minutes has elapsed since the recording head was mounted. (The recording head has a built-in heater.)

Note 3: Handling recording heads

- Do not knock or shake recording heads as this can cause faults.
- The inks are not harmful but they are very difficult to remove if they adhere to the skin or to clothes, so handle heads carefully in order to avoid staining. Also, do not disassemble them.
- If, by accident, it happens that ink gets into your eyes, wash thoroughly with water as an emergency measure and then immediately consult a specialist doctor.

Note 4: Storage of recording heads

When they are delivered, recording heads are in aluminium packs.

If you are not going to use a head straight-away, leave it sealed and store it in a cool, dark place with an average temperature of 5 to 30°C.

Note 5: Shipping of recording head

- Do not ship the unit recording head after the aluminum pack was opened up.
If it is necessary to ship the unit recording head under avoidable circumstances, be sure to close the cap, and ship it as contained in a boxboard in the state where vibration and impact are eased using cushioning materials.
- Always close the cap if you are transporting a head while it is still installed in the recorder main unit.

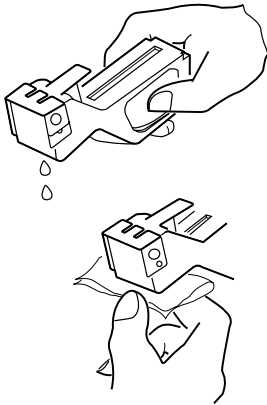
Note 6: If the ink is not sprayed.

- (1) Hold the recording head with turning the nozzle surface downward and push the side strong till spilling two drops.
 - (2) Absorb the standing ink on the nozzle surface with the cloth attached.
 - (3) Hold the cloth to the nozzle surface again to find all colors flowed onto cloth.
- * When working environment is 15°C or less, perform print-out of "record" or "test pattern" after a period or several minutes has elapsed since the recording head was mounted. (The recording head has a built-in heater.)

Reference: Ink consumption

This varies depending on the conditions of use but with a chart speed of 25mm/h and recording of constant input, the amount of consumption is as follows.

About 3 months in the case of 24 points records

An ink dry-up warning-detection function produces a warning display in the display section and a warning print-out the recording paper.

(See Section 11.12 for an example of print-out.)

5.3 Changing the type of input signals

This recorder is a multi-input type which permits the input for any channel to be changed to thermocouple, resistance bulb or DC voltage input.

Follow the procedure described below if you wish to change the type of input signals subsequent to purchase.

Step 1

Turn off the power.

Step 2

Open the front flap and remove the main unit in the manner shown in the drawings below.

Step 2-1

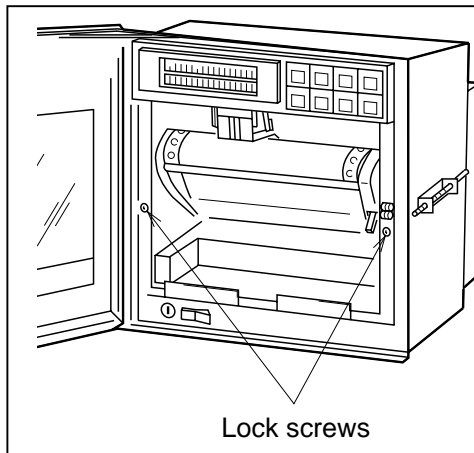

Loosen the lock screws on the left and right and remove them.

Step 2-2

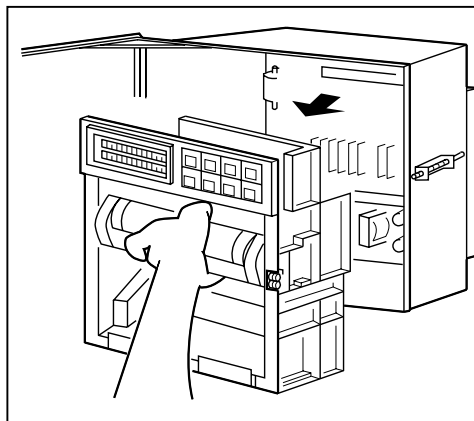

Grip the paper feed frame and pull it firmly towards you. This detaches it from the main unit.

Step 2-3

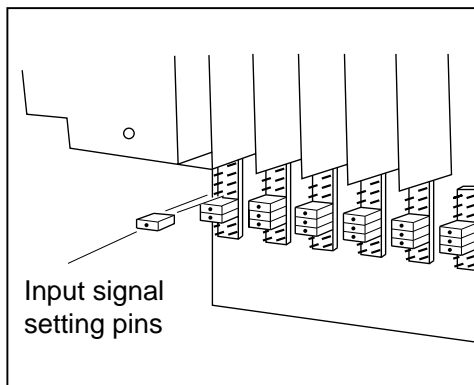

Change the settings of the pins for individual channels on the internal printed circuit board. (See the method of changing pin positions on the next page.)

* If there are not enough pins, use the accessory input signal setting pins.

* Use pliers, to remove the insert pins.

Method of changing pin position

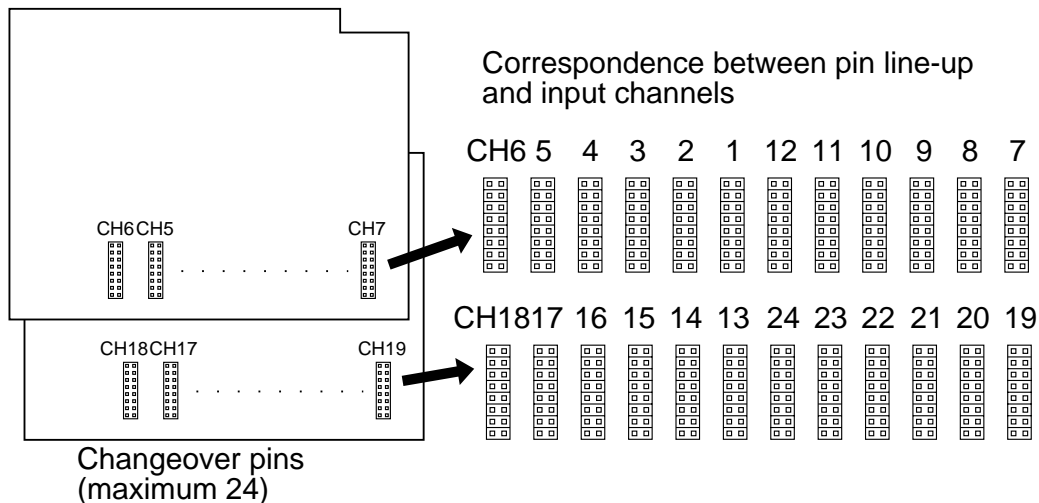

Pin position for different types of inputs

Pin setting is required in correspondence with types of inputs for each channel. The set position is as shown below.

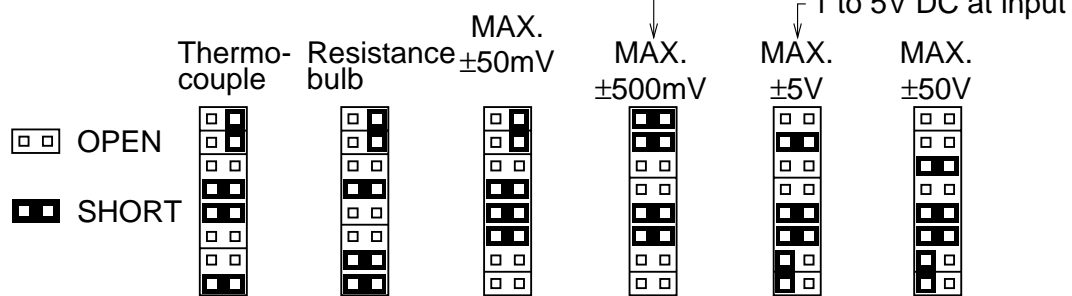

Step 2-4

After completing the change, push the main unit back into its original place and fix it with the left and right lock screws.

Step 2-5

Change the input terminal wiring to make it correspond to the new input signal type. For DC voltage input, provide the input terminals with shunt resistors. Example: In the case of 4 to 20mA DC input, fit the separately sold shunt resistors (10Ω) and set to $\pm 500\text{mV}$ range input pin positions.

Step 2-6

Refer to Section 7.8 and carry out front-panel keyboard operations in order to change setting in correspondence to change types of input signals.

[Note] DC current input is converted into voltage by shunt resistor (10Ω):
 In 4 to 20mA DC : 40 to 200mV DC range
 In 10 to 50mA DC : 100 to 500mV DC range

6. OPERATION AND ACTIONS

6.1 Before running the equipment:

Check the following points before starting operation.

1. Recording paper, recording head installation

- (1) Loading chart paper See Section 5.1
- (2) Installation of recording head See Section 5.2

2. Wiring

- (1) Input terminals See Section 4.2
- (2) Alarm terminals (option) See Section 4.2
- (3) Power supply, ground terminals See Section 4.2

3. Do the input types and channels match?

- (1) Type specification See Section 1.3
- (2) Changing the type of input terminals See Section 5.3

6.2 Power switch-on and states

- (1) Open the front flap.
- (2) The power supply switch is at the above left; switch it on.

(1) Initial switch-on of power



(A cursor appears in the upper left of the display section.)



The recording head moves slowly to the left-hand end (the 0% side).



When the 0% point is detected, the recording head moves to a position that is about 50mm from the left-hand end and stops.



The input data and Tag No. are displayed in the display section.
(No recording takes place.)

(2) If the power is switched off while recording is stopped and switched on again:

The state becomes 'Recording stopped'.

(3) If the power is switched off during recording operation and switched on again:

The state becomes 'Recording in progress'.

Recording in progress



Power supply cut off



Display disappears

Recording stops



Power turned on again



(Cursor appears in top left of display section)



The recording head moves slowly to the left-hand end (the 0% side).



When the 0% point is detected, the recording head moves to a position that is about 50mm from the left-hand end (0%), moves back again to the left-hand end and is on standby



The input data is displayed in the display section and recording restarts.

(3) Chart paper fast feed (**FEED** key)

- To effect fast feed regardless of recording, press the **FEED** key.
- The speed is 3mm/s during the first second that the key is held depressed and goes to 8mm/sec after the elapse of 1 second.
- When the **FEED** key is released, there is a return to the set speed.

Note: If you press the Δ key while holding the **FEED** key depressed, the recording paper is moved backwards (a maximum of 25mm).

(4) Changing the display mode (**DISPLAY** key)

- Display modes can be selected at any time pressing the **DISPLAY** key during operation.
- An under-bar appears at the upper left of the channels 1 to 6 simultaneous display panel for instantaneous and multipoint display, and at the lower left of the channels 7 to 12 simultaneous display panel.
- There are the following changes in the display mode each time the **DISPLAY** key is pressed.

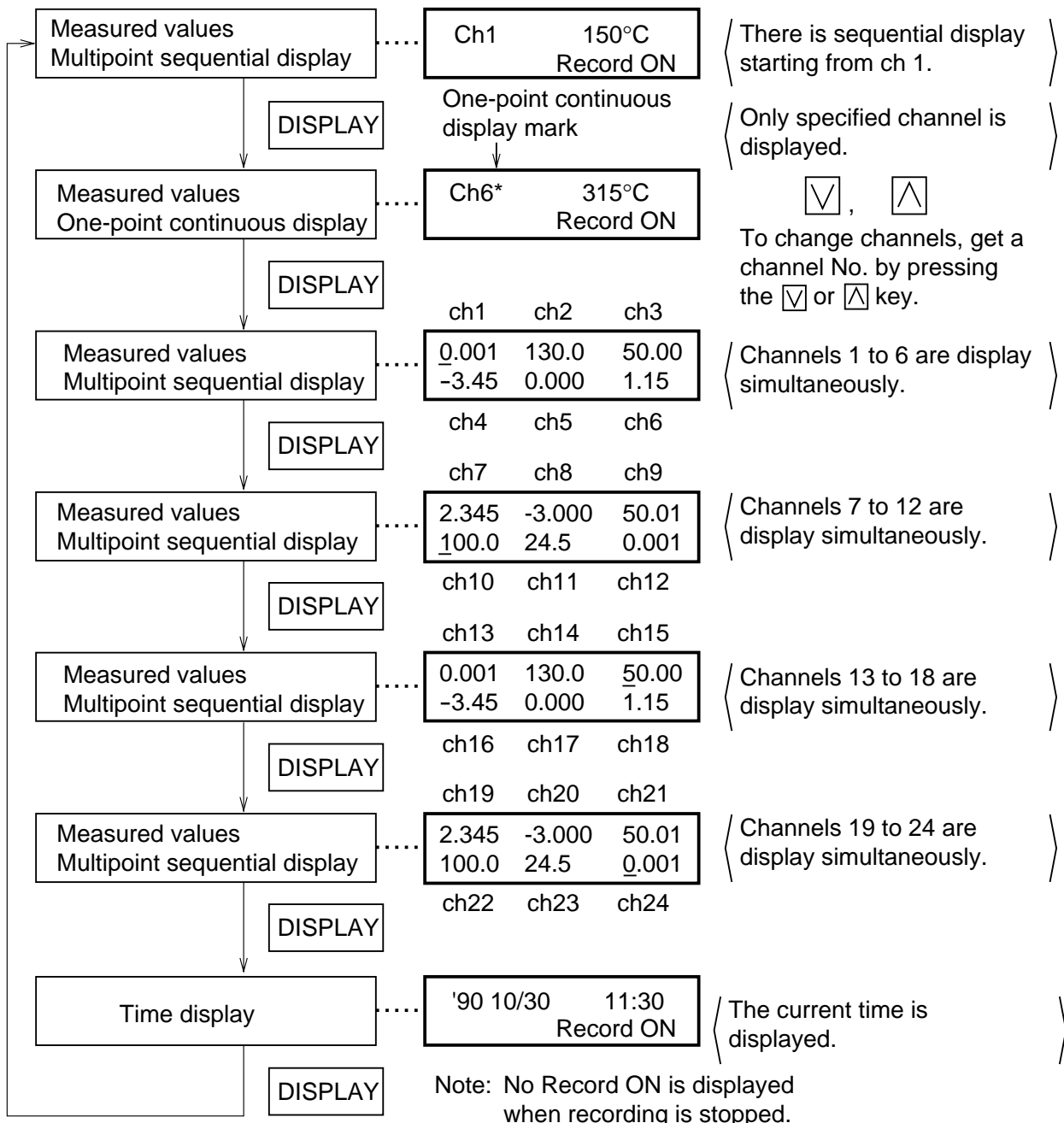

6.5 Displays and print-outs on detection (cancellation) of alarms

- (1) If an alarm is detected the display section gives a display as follows.

Example of alarm display

<table border="1" style="width: 100%; border-collapse: collapse;"> <tr> <td style="padding: 2px;">Ch2 123.5°C</td> </tr> <tr> <td style="padding: 2px;">Alarm Ch6 H ALM1</td> </tr> </table>	Ch2 123.5°C	Alarm Ch6 H ALM1	<p>Example: Upper section Lower section</p>	<p>Ch 2 measured value Alarm in Ch 6 H alarm, relay No. 1</p>
Ch2 123.5°C				
Alarm Ch6 H ALM1				
<p>This display continues until it is cancelled.</p>				

- (2) When an alarm detected and cancelled, the relevant details are printed on the right-hand side of the chart paper.

On detection: The time of detection, channel No., type of alarm, relay No.—Print-out color: Red

On cancellation: The time of cancellation, channel No., relay No.—Print-out colour: Black

Typical alarm display

(1) H alarm occurred with Ch 1 No. 1.
Relay No. 1, occurred time 14:48.

(2) H alarm of Ch 1 No. 1 was canceled.
Relay No. 1, canceled time 14:56.

- (3) If an alarm is detected or a cancellation is made during data print-out or list print-out, the alarm print-out takes place after completion of the data or list print-out.
- (4) Up to a maximum of 30 alarm detection cancellation information can be stored and sequentially printed out, but if the storage capacity is exceeded because of a large number of detections/cancellations in a short time, information in the overflow portion is discarded and cannot be printed out.

6.6 Displays and print-outs on occurrence of burnt-out

- (1) If a thermocouple or resistance bulb wire breaks, the relevant details are indicated in a display

Example of burn-out display

<table border="1" style="width: 100%; border-collapse: collapse;"> <tr> <td style="padding: 2px;">Ch6</td> <td style="padding: 2px;">Burn-out Record on</td> </tr> </table>	Ch6	Burn-out Record on	<p style="text-align: right;">Ex.: Burn-out in Ch 6</p>				
Ch6	Burn-out Record on						
<table border="1" style="width: 100%; border-collapse: collapse;"> <tr> <td style="padding: 2px;">0.1</td> <td style="padding: 2px;">-4.00</td> <td style="padding: 2px;">0.01</td> </tr> <tr> <td style="padding: 2px;">1.00</td> <td style="padding: 2px;">2.00</td> <td style="padding: 2px;">Burn-out</td> </tr> </table>	0.1	-4.00	0.01	1.00	2.00	Burn-out	
0.1	-4.00	0.01					
1.00	2.00	Burn-out					

Note: The trend record is switched to the maximum value side of the record range.

- (2) If a burn-out occurs, details of the burn-out are printed on the right-hand side of the chart paper.
(Print-out color : Red)

Example of burn-out print-out

<table border="1" style="width: 100%; border-collapse: collapse;"> <tr> <td style="padding: 2px;">Ch1</td> <td style="padding: 2px;">Burn-out</td> <td style="padding: 2px;">11:52</td> </tr> </table>	Ch1	Burn-out	11:52	<p>Time of occurrence : 11. 52 Channel No. :1</p>
Ch1	Burn-out	11:52		

6.7 Over-range, under-range display and abnormal input display

In all cases, for thermocouples, resistance bulbs and DC voltage input, there is a reference range for input signals. If input is outside preset range an 'Over' or 'Under' display is given.

Example of over/under display

Ch2 over °C Record ON	0.0 over 5.00 6.00 under 3.00
Ch 5 under °C Record ON	

In the case of voltage input, input error display appears when the input signal line was broken or when an over-input signal or an under-input signal was input.

Typical input error display

Ch3 Error Error Trend record	Error 3.0 4.0 5.0 6.0 7.0
------------------------------------	--

6.8 Display and record when chart paper runs out

When there is no more chart paper, a display as follows is given and recording automatically stops.

Display of measured values and alarm monitor continue.

Ch6 123.5°C Chart end

6.9 Display and record when the recording head ink is low

- (1) A display as follows is given on the chart paper when the amount of remaining ink is low. 'Ink Out' is displayed in the display section.

Example

Ch6 123.5°C Ink Out

- (2) 'Ink Out' is printed on the right-hand side of the chart paper.

< Print-out color : The color of the ink whose remaining quantity is low >

Note: 'Ink Out' is output when the amount of ink remaining is about 10% or less and so recording can continue for a little while even if 'Ink Out' is output.

6.10 Display when data backup batteries need to be replaced

When the voltage of back-up batteries becomes low, a display indicating that they need to be replaced is given.

'Battery End' is displayed in the display section.

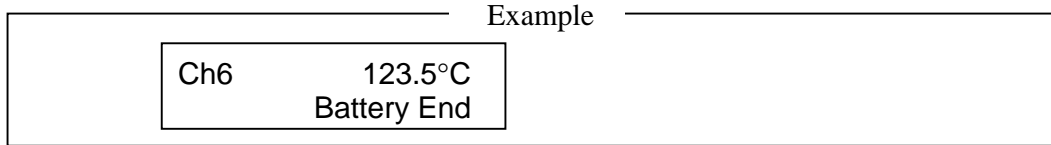

Replace the batteries promptly when a 'Battery End' display appears page 8-3.

6.11 Display of fault in recording head carriage

If a fault in the recording head carriage occurs and the recording head can no longer function normally, a fault display is given and the recording operation stops.

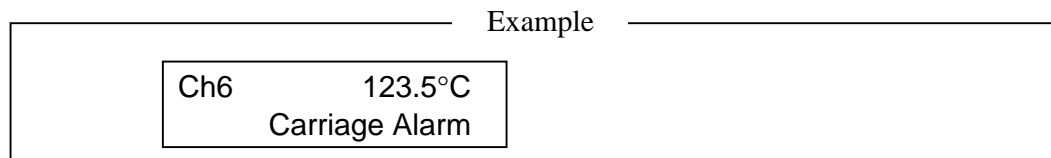

If a 'Carriage Alarm' display is given, check the following points.

- (1) Is foreign matter adhering to the recording head carrier shaft ?
- (2) Is the wire that drives the recording head broken or slack ?
- (3) Has the recording paper lifted up and come into contact with the recording head ?
- (4) Is the recording head set in place correctly ?

After eliminating the cause of the fault, switch on the power supply of the main unit.

6.12 Order of priority of state displays

If the items noted below occur simultaneously, the corresponding displays are given in the indicated order.

1. Chart end
2. Carriage alarm
3. Ink end
4. Battery end
5. Alarm

Note: When the state displays 1 and 2 above are given, the SELECT key is inoperative.

However, the DISPLAY and FEED keys are operative.

7. SETTING AND CHECKING PARAMETERS

7.1 Setting and checking

- (1) The parameters at the time of shipment are as indicated in the table below.
Recorder operations (displays, analog trend recording) can be effected simply by switching the power on without making any adjustments, but you can set the parameters you require.
- (2) The record ranges are multirange and it is necessary to set the required ranges.
- (3) Alarms, Tag Nos., message, scaling, square root extraction and subtract calculation, daily report and totalize functions are not set. Please set these if they are required. Input filters are set to 3 seconds.

Note: If you set parameters, always do so after setting chart paper in place. If chart paper is not installed, the SELECT key is inoperative.

(1) Values of parameters at the time of shipment (initial values)

Parameter name	State at time of shipment (initial values)	Remarks	Method of setting checking
Pass code	(Cancelled)	Setting range: 0 to 9999	Section 7.3
Main chart speed	25mm/h	Setting range: 5 to 1500mm/h	Section 7.4
Sub-chart speed (option)	25mm/h	Setting range: 5 to 1500mm/h Changed by external contact input	Section 7.4
Alarms	No. 1 to 4: NO Set value: 0 ALM: 0	4 kinds and 4 points, L, H, RH and RL, are available for each channel (relay output: option).	Section 7.5
Recording mode	Trend recording	Trend recording/logging recording selection	Section 7.6
	Periodic print-out: ON	Periodic digital print-out on/off selection	
	Scale print-out: ON	Fixed interval scale lines, digits, units print-out selection of ON/OFF	
	Recording format: Standard	Standard, auto-range recording, zoom records, zone recording selection	
Record range	Thermocouple system: 0 to 1200°C, K Resistance bulb system: 0 to 500°C, Pt DC voltage system: DC -5 to 5V	Specification of record range	Section 7.7
Input selection	Thermocouple: K thermocouples, °C Resistance bulb: Pt 100, °C	Input type specification, °C, °F specification	Skip/copy setting
	DC voltage: V	mV, V' specification	
	Input filter: 3 seconds	Setting range: 0 to 900 seconds	Section 7.8
	Scaling: OFF	DC voltage input scaling can be set (working values, units)	
	Router: OFF	DC voltage input router (square root extractor) can be specified	
	Logarithmic calculation: OFF Subtract calculation: OFF	Recording of differences between channels can be specified	
TAG No.	Blank	Up to 8 alphanumeric characters	Section 7.9
Message print	Blank Print position: 0mm Print timing: Manual	10-message, alphanumeric: Within 16 characters	Section 7.10
List print-out	—	Parameter list print-out, scale print-out, test pattern print-out, daily report, totaling list	Section 7.11
Daily report	Function: OFF Automatic print-out: ON Start time: 00:00 End time: 00:00	Daily report function on/off selection, start time selection Daily report list automatic print-out on/off selection Daily report operation on/off setting for each channel	Section 7.12
Totalize	Function: OFF Automatic print-out: ON Start time: 00:00 End time: 00:00	Totalize function on/off selection, start time selection Totalize list automatic print-out on/off selection Totalize operation on/off setting for each channel	Section 7.13
RS-485 transmission (option), T-link transmission (option)	Station No.: 1 Baud rate: 19200 bps Stop bit: 1 Parity: odd	Specified if there is connection with parent CPU	Not available
Time setting	Current time setting	Display in the order, Yea, Month, Day, Hours, Minutes	Section 7.16
Ink monitor clear	NO	Setting of ink end warning-detection function Always set to clear (YES) after recording head replacement	Section 7.16
Recording paper illumination lamp (option)	ON	Set to "OFF" to turn out the recording paper illumination lamp	Section 7.17

7.2 Outline of procedure for setting parameters

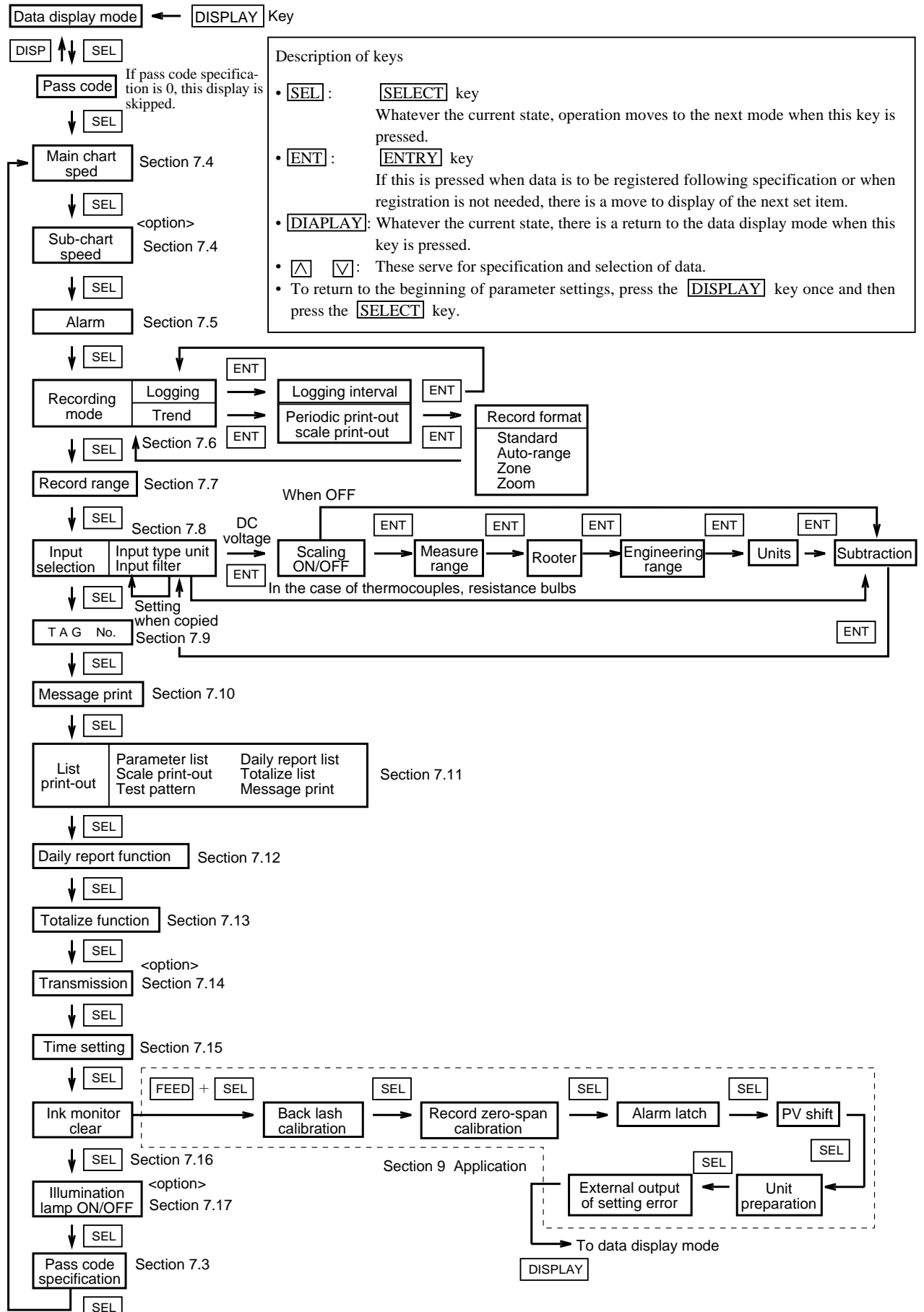

7.3 Pass code setting

Explanation

If the pass code is set to a value other than 0, it is necessary to enter the correct pass code before changing parameter setting pass code. A numerical value is specified on the screen by means of the Δ and ∇ keys and is input by the ENT key. If this value is the same as the previously set pass code, there is a move to a display of the next parameter.

If the pass code is incorrectly specified, the keys are locked as follows.

Preset pass code < 5000

Only the list display is given and it is not possible to change parameter settings.







Preset pass code \geq 5000

The list display is given, but list print-out is inhibited.

Furthermore, RECORD , LIST , and FEED keys on the front panel are locked.

At the time of shipment, the pass code is set to 0 and the key lock is released.



If the pass code is 0, the pass code display is skipped.

Key actuation (example)	Setting of the pass code	
Key operation	Explanation	Display
SEL 	Press the SEL key several times to bring up the pass code specification display.	<div style="border: 1px solid black; padding: 5px; width: fit-content;">PRESET PASS CODE □□□□</div>
Δ ∇ 	Press the Δ ∇ keys to specify the value you want for the pass code (specification range 1 to 9999).	<div style="border: 1px solid black; padding: 5px; width: fit-content;">PRESET PASS CODE □□□□</div>
ENT 	Press the ENT key to register the value. When it has been registered, there is a move to the next parameter.	<div style="border: 1px solid black; padding: 5px; width: fit-content;">MAIN CHART SPEED □□□□ mm/h</div>
DISP 	Press the DISP key to go to the data display mode.	<div style="border: 1px solid black; padding: 5px; width: fit-content;">ch1 123.4°C</div>
SEL 	Press the SEL key to bring up the pass code input screen.	<div style="border: 1px solid black; padding: 5px; width: fit-content;">PASS CODE =? □ 0</div>
Δ 	Press the Δ key to give the value of the pass code that has been specified.	<div style="border: 1px solid black; padding: 5px; width: fit-content;">PASS CODE =?</div>
ENT 	Press the ENT key to effect registration. Note: If the value input at this time is different from the pass code that has already been specified, the list screen comes up (key lock state). In this case, it is not possible to clear the pass code, so go through the process again from the beginning and input the correct value. If the value input is the same as the pass code value, there is a move to the next parameter.	<div style="border: 1px solid black; padding: 5px; width: fit-content;">LIST = 1 PARAMETER LIST</div> <div style="border: 1px solid black; padding: 5px; width: fit-content;">MAIN CHART SPEED □□□□ mm/h</div>

7.4 Setting the chart speed (main chart speed/sub-chart speed)



Explanation

- Main chart speed: This is the procedure for setting the chart speed in normal operation.
The setting range is 5 to 1500mm/h. (Can be set in 1mm/h steps.)
- Please note that **the following digital print-outs are not possible** if the chart speed of dot recording type is 51mm/h or more.
'Periodic print-out' 'Scale print-out' 'Message print-out' 'Alarm print-out' 'Parameter print-out' 'Ink Out print-out'.
However, a 'Scale print-out' 'Message print-out' can be made manually.
See Section 7.11.

Key actuation (example)	Changing the normal chart speed of 25mm/h to 20mm/h	
Key operation	Explanation	Display
<div style="border: 1px solid black; padding: 2px; display: inline-block;">SEL</div> 	Press the <div style="border: 1px solid black; padding: 2px; display: inline-block;">SEL</div> key twice to display the main chart speed. (In case where pass code =0)	<div style="border: 1px solid black; padding: 5px; display: inline-block;">MAIN CHART SPEED 25mm/h</div>
<div style="border: 1px solid black; padding: 2px; display: inline-block;">▽</div> 	Press the <div style="border: 1px solid black; padding: 2px; display: inline-block;">▽</div> key to set to '20'	<div style="border: 1px solid black; padding: 5px; display: inline-block;">MAIN CHART SPEED 20mm/h</div>
<div style="border: 1px solid black; padding: 2px; display: inline-block;">ENT</div> 	Press the <div style="border: 1px solid black; padding: 2px; display: inline-block;">ENT</div> key to effect registration. There is a move the display of the next parameter.	<div style="border: 1px solid black; padding: 5px; display: inline-block;">SUB CHART SPEED 25mm/h</div>



Explanation

Sub-chart speed: This is the chart speed when its rate is controlled by a remote control signal.
 The setting range is 5 to 1500mm/h. (Can be set in 1mm/h steps.)
 The optional external control unit is necessary.

Key actuation (example)	Changing the recording paper feed of speed 100mm/h to 150mm/h by an external control signal (DI)	
Key operation	Explanation	Display
<div style="border: 1px solid black; padding: 2px; display: inline-block;">SEL</div> 	Press the <div style="border: 1px solid black; padding: 2px; display: inline-block;">SEL</div> key 3 times to display the sub-chart speed. (In case where pass code = 0)	<div style="border: 1px solid black; padding: 5px; text-align: center;"> SUB CHART SPEED 100mm/h </div>
<div style="border: 1px solid black; padding: 2px; display: inline-block;">^</div> 	Press the <div style="border: 1px solid black; padding: 2px; display: inline-block;">^</div> key to set to '150'.	<div style="border: 1px solid black; padding: 5px; text-align: center;"> SUB CHART SPEED 150mm/h </div>
<div style="border: 1px solid black; padding: 2px; display: inline-block;">ENT</div> 	Press the <div style="border: 1px solid black; padding: 2px; display: inline-block;">ENT</div> display moves to next parameter.	<div style="border: 1px solid black; padding: 5px; text-align: center;"> ALARM ch1 HH=OFF 0°C ALM0 </div>

7.5 Setting alarms

Explanation	
• Channel No.:	Set the No. of the channel in which alarms are to be set.
• Alarm type:	The 4 types H, L, RL, RH (H, L, RL and RH can be set on the same alarm.) When No. is selected, alarm operation is stopped. (There is no alarm display, print-out or alarm output.)
• Alarm set values:	Set to engineering values (absolute value alarms).
• ALM:	Set option alarm unit relay Nos. (1 to 12; no output with 0).

Key actuation (example)	Change of channel No. 1 L → H 30°C →80°C OFF→ON ALM 1→6	
Key operation	Explanation	Display
<div style="border: 1px solid black; padding: 2px; display: inline-block;">SEL</div> 	Press the <div style="border: 1px solid black; padding: 2px; display: inline-block;">SEL</div> key several times to give the alarm display. (In cases where pass code = 0)	<div style="border: 1px solid black; padding: 5px; display: inline-block;">ALARM ch 1L=OFF 30°C ALM1</div>
<div style="border: 1px solid black; padding: 2px; display: inline-block;">ENT</div> 	Select channel No. to change and press the <div style="border: 1px solid black; padding: 2px; display: inline-block;">ENT</div> key.	<div style="border: 1px solid black; padding: 5px; display: inline-block;">ALARM ch 1L=OFF 30°C ALM1</div>
<div style="border: 1px solid black; padding: 2px; display: inline-block;">△</div> <div style="border: 1px solid black; padding: 2px; display: inline-block;">ENT</div>	Press the <div style="border: 1px solid black; padding: 2px; display: inline-block;">△</div> key to change "L" to "H" and press the <div style="border: 1px solid black; padding: 2px; display: inline-block;">ENT</div> key to effect registration.	<div style="border: 1px solid black; padding: 5px; display: inline-block;">ALARM ch 1H=OFF 30°C ALM1</div>
<div style="border: 1px solid black; padding: 2px; display: inline-block;">△</div> <div style="border: 1px solid black; padding: 2px; display: inline-block;">ENT</div>	Press the <div style="border: 1px solid black; padding: 2px; display: inline-block;">△</div> key to change the set value from "30°C" to "80°C" and press the <div style="border: 1px solid black; padding: 2px; display: inline-block;">ENT</div> key to effect registration.	<div style="border: 1px solid black; padding: 5px; display: inline-block;">ALARM ch 1H=ON 80°C ALM1</div>
<div style="border: 1px solid black; padding: 2px; display: inline-block;">△</div> <div style="border: 1px solid black; padding: 2px; display: inline-block;">ENT</div> 	Press the <div style="border: 1px solid black; padding: 2px; display: inline-block;">△</div> key to change the ALM No. from "1" to "6" and press the <div style="border: 1px solid black; padding: 2px; display: inline-block;">ENT</div> key to effect registration. (When the <div style="border: 1px solid black; padding: 2px; display: inline-block;">ENT</div> key is pressed, the channel No. flashes and the setting is completed. Follow the same procedure for setting in other channels.	<div style="border: 1px solid black; padding: 5px; display: inline-block;">ALARM ch 1H=ON 80°C ALM6</div>

Note: RH, RL High/low limit alarm for variation rate. Alarm is emitted when variation rate per input exceeds the set value of each alarm.

7.6 Setting the recording mode

The following recording modes can be set in this section.

- (1) Logging recording (logging)
- (2) Periodic print-out
- (3) Scale print-out
- (4) Auto-range recording (auto-range)
- (5) Enlarged/reduced recording (zoom)
- (6) Zone recording (zone)

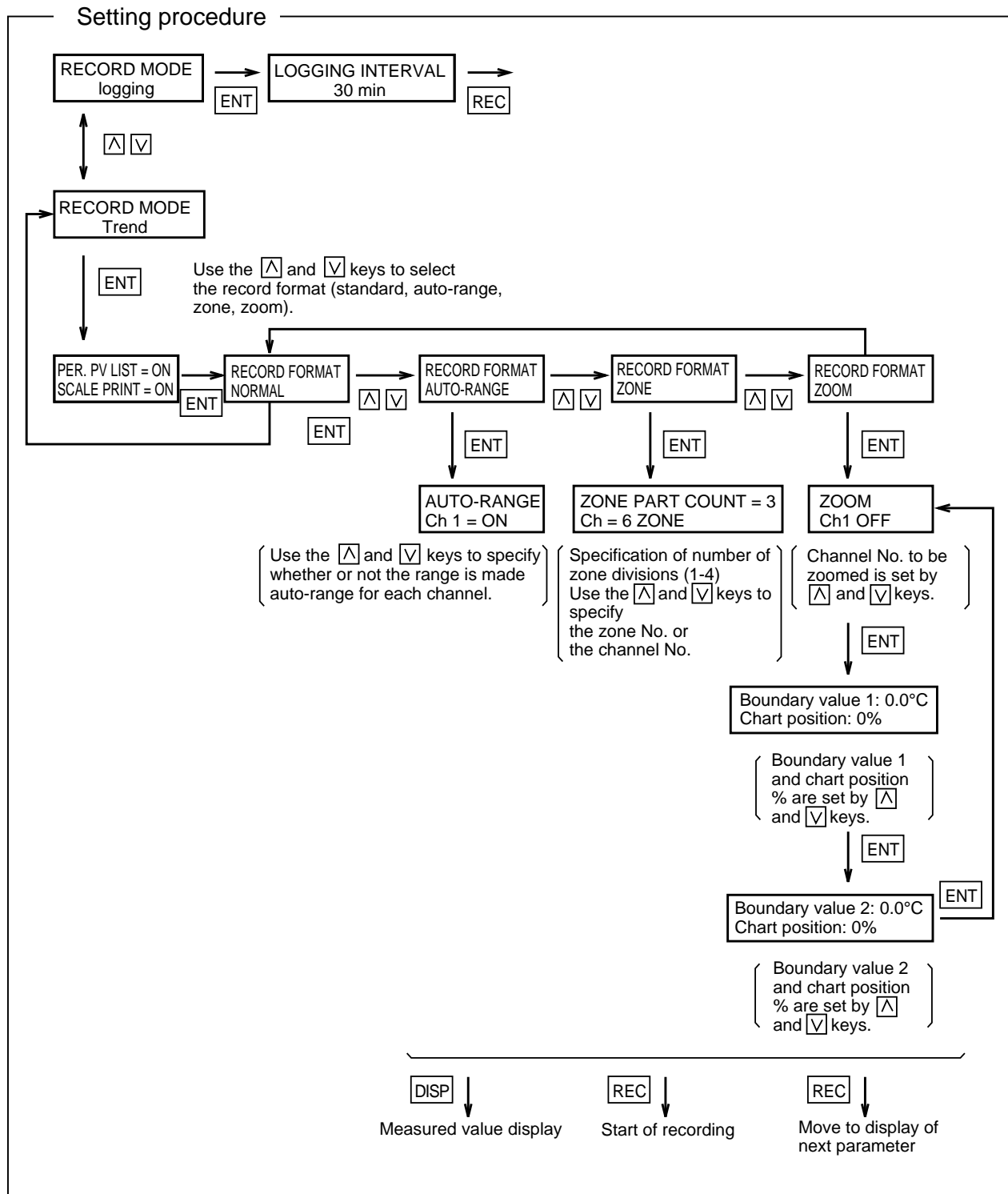

(1) Logging recording (logging)

- In this case, there is no analog trend recording but a record of data (the time channel Nos., measured values, units) is produced at specified intervals of time (10 to 60 minutes can be specified.)
- If there is detection or clearing of an alarm during logging print-out, this is printed on the right-hand side of the recording paper. (Example of print-out: Section 11.9)

(2) Periodic print-out

- The following items are printed out at set intervals in depending on chart speed. Time line, time, chart speed, channel Nos., measured values, engineering units.
- This print-out is effected alternately with scale print-outs.
- It is not effected if the periodic print-out is set to "OFF".

(3) Scale print-out

- Scale lines, digits, unit and Tag Nos. are printed out at set intervals.
- This print-out is effected alternately with periodic print-outs.
- It is not effected if the scale print-out is set to "OFF".
- If both scale print-out and periodic print-out are set to "ON", the print-outs are effected alternately at set intervals.

Periodic print-out and scale print-out time intervals sub heading

The time intervals of print-outs vary depending on the chart speed.

Chart speed (mm/h)	5 to 9	10 to 19	20 to 39	40 to 79	80 to 159	160 to 239	240 to 320
Print-out time interval	12 h	8 h	4 h	2 h	1 h	30 min	20 min

Chart speed (mm/h)	321 to 480	481 to 1500
Print-out time interval	15 min	10 min

When the chart speed exceeds 51mm/h, only the time line is recorded.

Periodic print-out and scale print-out are not effected.

Note: If the time for a periodic print-out or scale print-out arrives while data printing or other list printing is in progress, the periodic print-out or scale print-out is not made.

If data print-out is started while a periodic print-out or scale print-out is in progress, the periodic print-out or scale print-out is halted partway through.

(4) Auto-range recording (auto-range)

If input outside the record range occurs, recording is effected with the record range automatically changed. The record range after a change goes 50% of the span to the plus side or the minus side. Note that the recording span does not change. (Made effective with an ON setting.)

Example: With a 0 to 100°C record range (recording span 100°C)

- If input goes beyond the range in the positive direction, there is a change to 50 to 150°C.
- If input goes outside the range in the negative direction, there is a change to -50 to +50°C.

Note 1: A change in the range is only effected once in a given direction.

Once a range has changed in the positive direction, it does not change again even if the record range is exceeded again.

Note 2: If the record range changes because it has been exceeded in the positive direction and then input below the new range in the negative direction there is a return to the original range. (The reverse also applies.)

Note 3: A mark is printed in black at the right-hand edge of the recording paper when the range changes.

Note 4: There is a record range MAX. value and MIN. value for each type of input.

Consequently, if a change means that a range is going to go beyond the MAX. value or MIN. value for the record range of the type of input in question, the MAX. value or MIN. value imposes a limit.

Example: For a K thermocouple 0 to 1000°C record range

- If over-range occurs: change to 400 to 1400°C
- If under-range occurs: change to -230 to 770°C

Note 5: Auto-range recording cannot be specified simultaneously with zoom recording or zone recording.

(5) Enlarged/reduced recording (zoom)

Within the record range (record range) for each channel, there are three recording scales. This makes it possible to have an enlarged record in one portion and a reduced record in the other portion.

Example: With a 0 to 100°C record range:

Suppose you want to enlarge 40 to 60°C record in a 10 to 90% range.

(The 0 to 10% range becomes a reduced record of 0 to 60°C, and the 90 to 100% range becomes a reduced record of 60 to 100°C)

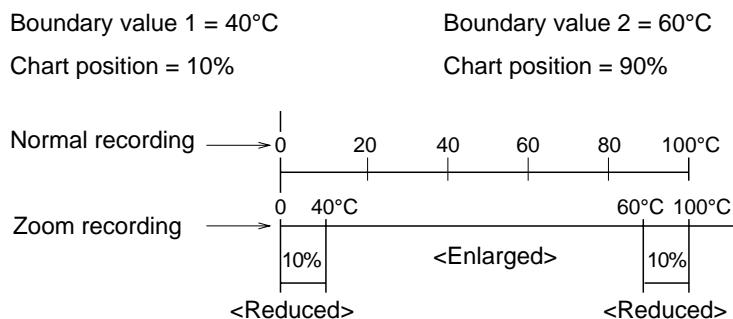

Note 1: Do not set the normal recording 0% value at the 100% recording position or the normal recording 100% value at the 0% recording position.

If you do, proper operation becomes impossible.

Note 2: If zoom recording is specified, scale print-out digits are printed only for the 4 points 0% and 100% of the record range, and the boundary value 1 and the boundary value 2. (Boundary value scale digits are printed only if the record position is 15 to 85% and when the difference between boundary value 1 and boundary value 2 is less than 7%, only the small chart position is printed.)

Example: With a record range 0 to 500°C, the boundary value 1 of 200°C, chart position of 30%, and the boundary value 2 of 300°C, chart position of 70%.

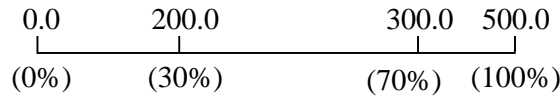

Note 3: Zoom recording cannot be specified simultaneously with auto-range recording or zone recording.

(6) Zone recording (zone)

- The recording width is 180mm and overlap of the records of different channels is prevented by the provision of recording zones for the various channels.
- Any zone can carry the record of any channel.
- The number of divisions is up to a maximum of 4 zones.

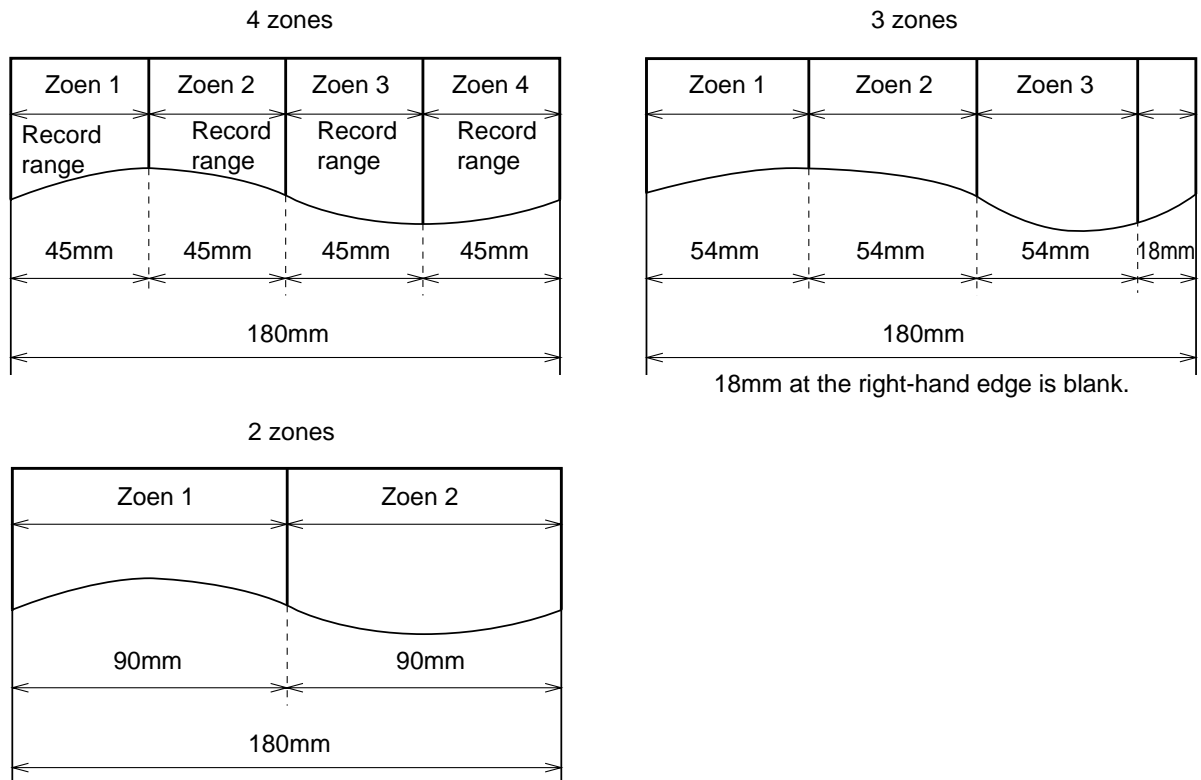

Note 1: For scale print-outs when zone recording is specified, there is a print-out only of scale digits for the 2 points record range 0% and 100%.

Note 2: During zone recording, alarm print-outs and burn-out print-outs are produced at the right-hand edge whatever the zone.

Note 3: Zone recording cannot be specified simultaneously with auto-range recording or zoom recording.

7.7 Setting record ranges

Explanation

An individual record range is set for each channel. 'Record range' means the 0% and 100% position scale on recording paper. If DC voltage input scaling is set and used, set the record range after setting scaling. If scaling is set, the decimal point position is the same one as set by the engineering value.





















Key actuation (example)	The record range of channel 1 is changed from 0 to 100°C to -50 to 50°C.	
Key operation	Explanation	Display
 	Press the  key several times to give the recording range display.	
 	Since channel No. 1 is selected, press the  key.	
 	Press the  key to change the range lower limit from "0" to "-50" and press the  key.	
  	Press the  key to change "100" to "50" and press the  key. (When the  key is pressed, the channel No. flashes and the setting is completed. Follow the same procedure for settings in other channels.)	

Table 1 Specifiable ranges record ranges

Type		Reference range	Reference range	Specifiable ranges for record range	
Thermocouples	B	400 to 1760°C	725 to 3200°F	370.0 to 1790.0°C	698.0 to 3254.0°F
	R	0 to 1760°C	32 to 3200°F	-30.0 to 1790.0°C	-22.0 to 3254.0°F
	S	0 to 1760°C	32 to 3200°F	-30.0 to 1790.0°C	-22.0 to 3254.0°F
	K	-200 to 1370°C	-328 to 2498°F	-230.0 to 1400.0°C	-382.0 to 2552.0°F
	E	-200 to 800°C	-328 to 1472°F	-230.0 to 830.0°C	-382.0 to 1526.0°F
	J	-200 to 1100°C	-328 to 2012°F	-230.0 to 1130.0°C	-382.0 to 2066.0°F
	T	-200 to 400°C	-328 to 752°F	-230.0 to 430.0°C	-382.0 to 806.0°F
	N	0 to 1300°C	32 to 2372°F	-30.0 to 1330.0°C	-22.0 to 2426.0°F
	W	0 to 1760°C	32 to 3200°F	-30.0 to 1790.0°C	-22.0 to 3254.0°F
	L	-200 to 900°C	-328 to 1652°F	-230.0 to 930.0°C	-382.0 to 1706.0°F
	U	-200 to 400°C	-328 to 752°F	-230.0 to 430.0°C	-382.0 to 806.0°F
	PN	0 to 1300°C	32 to 2372°F	-30.0 to 1330.0°C	-22.0 to 2426.0°F
	Resistance bulbs	JPt 100	-200 to 600°C	-328 to 1112°F	-230.0 to 630.0°C
Pt100		-200 to 600°C	-328 to 1112°F	-230.0 to 630.0°C	-382.0 to 1166.0°F
DC voltage		-50 to +50mV		-55.0 to +55.0mV	
		-500 to +500mV		-550.0 to +550.0mV	
		-5 to +5V		-5,500 to +5,500V	
		-50 to +50V		55.00 to +55.00V	

The range -32767 to 32767 (decimal points can be located wherever required) can be specified for the record range in scaling or difference calculation specifications.

(1) Setting and changing input signal type

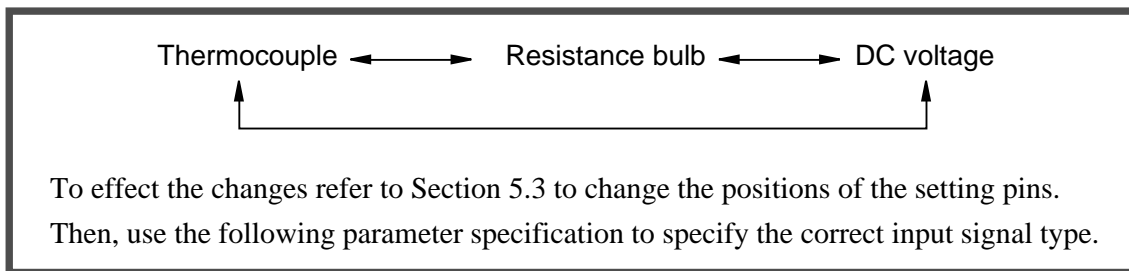

Example: Changing 5V input signal type of channel 6 to thermocouple input

```
Ch1  K    °C
FILTER  T=3sec
```

Use the Δ , ∇ keys to select channel 6 and press the ENT key.

↓ ENT

```
Ch1  K    °C
FILTER  T=3sec
```

The current '5V' value is flashing: press the Δ , ∇ keys to select the 'K' input type and press the ENT key.

Note:

The type of input is displayed in the following order by pressing the Δ key (in reverse order with ∇ key).

```
K → E → J → T → R → S → B → N → W → L → U → PN → Pt → JPt → 50mV
                                     ↓
                                     Skip ← Copy ← COM ← 50V ← 5V ← 500mV
```

↓ ENT

```
Ch6  K    °C
Jumper Setting OK?
```

There is output of a display asking you to check the change in setting pins and the type of input after the change. Please check that the work of changing the setting pins has been completed. If everything is OK, press the ENT key.

(2) Setting and changing the input filter

```
Ch6  K    °C
FILTER  T=3sec
```

If there is no change in the filter, press the ENT key.
Input filter setting range: 0 to 900 sec. (in 1 sec. Units)

↓ ENT

```
SUBTRACTON
Ch1→Ch0→Ch6
```

There is a move to the next parameter.

(3) Scaling, scaling ranges, units

- For DC voltage input, scaling is set to "ON" or "OFF".
- The Δ and ∇ keys are used to set the measurement range.
(The left-hand side is the lower limit and the right-hand side the upper limit.)
- The Δ and ∇ keys are used to specify scaling range for the corresponding measurement range.
(Range of -32767 to 32767; decimal point can be located anywhere)

- The decimal point positioning

When the **ENT** key is pressed following setting of the upper limit value, the lower limit value and the upper limit value both flash. The positions of the decimal points can now be changed by pressing the **△** and **▽** keys

Example: 0.00 to 10.00

Referring to the 'Units code table' on page 7 to 22, press the **△** , **▽** keys specify the units.

Example: Code A = 3, B = 2 → kg/h

Note: Relation between measuring range, industrial value, recording range and indicated value.

Example:

		Example 1	Example 2	Example 3	Example 4
Specifications	Input range	5V	5V	5V	5V
	Measurement range	1 to 5V	1 to 5V	1 to 5V	1 to 5V
	Engineering value	0 to 1000	0 to 1000	0 to 1000	0 to 1000
	Record range	0 to 1000	0 to 1000	0 to 2000	-1000 to 1000
	(Engineering Units)	(t/h)	(t/h)	(t/h)	(t/h)
If input is 1V	Indicated value	0 (t/h)	0 (t/h)	0 (t/h)	0 (t/h)
	Record	0% point	0% point	0% point	50% point
If input is 3V	Indicated value	500 (t/h)	500 (t/h)	500 (t/h)	500 (t/h)
	Record	50% point	50% point	25% point	75% point
If input is 5V	Indicated value	1000 (t/h)	1000 (t/h)	1000 (t/h)	1000 (t/h)
	Record	100% point	Over 100.5% point	50% point	100% point

Note: When setting scaling "ON", the recording range is cleared to zero. Set it again referring to Item 7.7 "Setting of recording range".

(4) Square root extraction

- This sets a rooter (square root extraction) function for each channel.

ON: operative

OFF: Inoperative

- This calculates square root of input values converted to % taking the specified measurement range to be 0 to 100%.

Negative input is regarded as 0%. Data (0 to 100%) after square root extraction are converted to scaling ranges.

Example: With Input range 5V

Measurement range: 1 to 5V

Working value: 0 to 1000 (t/h)

	Displayed value	Record
If the input is 1V (0%)	$(1000-0) \times \sqrt{0} = 0$ (t/h)	0% point
If the input is 3V (50%)	$(1000-0) \times \sqrt{0.5} = 707$ (t/h)	70.7% point
If the input is 5V (100%)	$(1000-0) \times \sqrt{1} = 1000$ (t/h)	100% point

(5) Logarithmic calculation

- Set the logarithmic calculation function of each channel.

ON: Valid OFF: Invalid

- Contents of logarithmic calculation function

(1) Indication and print format: $9.9E\pm 9$ Indication part: -9 to 9

Fixed-point part: First decimal place

Data range: 1.0×10^{-9} to 1.0×10^9

(When simultaneous display of 6 channels is made by the display unit on the front face, display is made like 1.0^{-9} if the characteristic is negative.

(2) Method for setup of engineering value and recording range

Setup of engineering value

Make setup by the characteristic only.

Ch1 Engineering value

0 ~9

($10^0 \sim 10^9$ is meant.)

Setup of recording range and of boundary value (at the time of zoom recording)

Make setup by the characteristic only.

Ch1 Recording range V

0 ~9

($10^0 \sim 10^9$ is meant.)

Typical setup

When measuring range 1-5V, engineering value 0-9 are set, input of 1-5V is converted to $10^0 \sim 10^9$.

At this time;

	Indicated value
Input 10 (0%)	1.0 E 0
Input 30 (50%)	1.0 E 4
Input 50 (100%)	1.0 E 8

Typical scale print: (Only the points of 10^n are printed.)

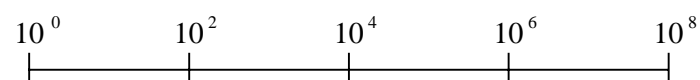

(3) Differential calculation and integration cannot be executed when logarithmic calculation is set. Furthermore, average values are not printed in the daily report list.

(5) Subtraction

- This is a specification for recording the result of calculation of the difference between 2 channels.
Example: The result of Ch1 to Ch3 is recorded in Ch1.
- Subtract calculations are only possible between channels for which the units and decimal point position are the same. (If they are different, results cannot be guaranteed.)
- If Ch0 is specified, no subtract calculation is performed.
- No subtract calculation is performed if there is a skip specification for a channel it is wished to use in the calculation

Precautions at the time of setup/change to input signal type, scaling and/or differential arithmetic operation

If you change the specification for input type, scaling, and subtract calculation, corresponding parameters will be initialized as follows. Make sure to check and re-configure the paramters.

Parameter \ Timing	Change input type set OFF to scaling	Set ON to scaling	Set 0 to subtraction (OFF)
Recording range	Initialized to default values.	Clear to 0	Initialized to default value
Alarm	All alarm (HH, H, L, LL, RL, RH) turn OFF and alarm set point and output relay No. 5 are cleared to 0.		
Auto range	Set auto range to OFF for changing channel.	—	—
Zoom	Set zoom to OFF for changing channel. Boundary value and channel position are cleared to 0.	—	—
Scaling	Scaling is OFF and measuring range, engineering value and unit are initialized.	—	Boundary value for changing channel is cleared to 0.
Router	Become OFF	—	—
Subtraction	Becomes differential calculation channel (differential calculation OFF)	—	—
PV shift	PV shift / Initial value shift = 0, inclination = 100% are obtained.	Same as left	—

Table of unit codes

Classification	Code B	1	2	3	4	5	6	7	8	9	10
	Code A										
Temperature, humidity	1	°C	°F					%RH	Vol%		
Flow rate	2	t/day	kg/day	g/day	Nm ³ /day	m ³ /day	Nl/day	l/day	cc/day		
	3	t/h	kg/h	g/h	Nm ³ /h	m ³ /h	Nl/h	l/h	cc/h		
	4	t/min	kg/min	g/min	Nm ³ /min	m ³ /min	Nl/min	l/min	cc/min		
	5	t/sec.	kg/sec.	g/sec.	Nm ³ /sec.	m ³ /sec	Nl/sec.	l/sec	cc/sec		
Pressure	6	MmH ₂ O	mH ₂ O	mmHg	cmHg	mHg	mmAq		mbar	bar	
	7	mg/cm ²	g/cm ²	kg/cm ²		N/mm ²	N/m ²		psi	Torr	
	8	mPa	Pa	kPa	Mpa						
Level, height	9	mm	cm	m					in	ft	
Capacity, weight, area	10	ml	l	kl		mm ³	cm ³	m ³		cc	
	11	mm ²	cm ²	m ²			g	kg	t		
Density	12	g/cm ²	kg/cm ²	g/m ³	kg/m ³	t/m ³	g/l	kg/l	g/ml		
Analysis	13	ppm	ppmNH ₃	ppmSO ₂	ppmH ₂ S	ppmCO	ppmO ₂	ppmNOx	ppb	pH	mol
	14	%	%H ₂	%CO ₂	%He	%Ar	%O ₂	%NaCl	%CO	cP	PO ₂
Force-energy	15	mN	N	Nm	gcm	kgcm	kgm		J	kJ	HP
Speed Acceleration	16	mm/sec.	mm/min	mm/h	m/sec.	m/min	m/h	km/h			
	17	Rps	rpm	rph		m/sec ²	rad/sec.				
Time	18	µsec.	msec.	sec.	min	h					
Electric-magnetism	19	MV	V	kV	µA	mA	A		A/T	Hz	dB
	20	W	kW	VA	kVA	Var	kVar	Ωcm	kΩcm	MΩca	µS/cm
	21	µF	F	mH	H	C	mΩ	Ω	kΩ	MΩ	µ
Heat, light	22	kcal	cal	kcal/m ²		lx	cd	lm	cd/m ²		
Radiation	23	cps	cpm	µSv/h	mSv/h	nGy/h	µGy/h	µm	g/m ²		
Others	24	Pa-s	mpa-s								

Note: Empty boxes are spaces.

Example of specification: kg/h is specified. Code A: 3

Code B: 2 specified











Ch1	UNIT
A=3	B=2

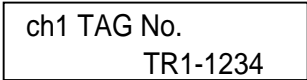

Area (B=10, A=1 to 12) means user definable unit refer to Section 9.4.

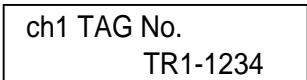
7.9 Setting Tag Nos.

Explanation

A Tag No. for each channel is specified by up to 8 alphanumeric characters. Specified Nos. are printed on the recording paper, so as to identify the channel to which measurement record applies.

Key actuation (example)	To change TAG No. "TR1-1234" to "RR1-ABCD".	
Key operation	Explanation	Display
 	Press the SEL key several times to give the Tag No. mode display.	<div style="border: 1px solid black; padding: 5px; width: fit-content;">ch1 TAG No. TR1-1234</div>
 	Since channel No. 1 is selected, press the ENT key	<div style="border: 1px solid black; padding: 5px; width: fit-content;">ch1 TAG No. TR1-1234</div>
  	The 1st place of the Tag No. flashes. Press  or  to indicate the character you want.	<div style="border: 1px solid black; padding: 5px; width: fit-content;">ch1 TAG No. RR1-1234</div>
 	Press the ENT key.	<div style="border: 1px solid black; padding: 5px; width: fit-content;">ch1 TAG No. RR1-1234</div>
	When the ENT key is pressed, the 2nd position of the Tag No. flashes. Specify this and subsequent place in the same way.	<div style="border: 1px solid black; padding: 5px; width: fit-content;">ch1 TAG No. RR1-A234</div>
	If 8 places are not needed, press the ENT key to make each position flash in turn. When the channel No. flashes, the specification is complete. Follow the same procedure to specify Tag Nos. for other channels	<div style="border: 1px solid black; padding: 5px; width: fit-content;">ch1 TAG No. RR1-ABCD</div>

Tag No. Table: The following characters and symbols can be specified. Select with the ,  keys.
(Total of 69 characters/symbols)

ABCDEFGHIJKLMNOPQRSTUVWXYZ
abcdefghijklmnopqrstuvwxyz
0123456789.*-*space

The TAG No. is printed in scale print, and in addition, is displayed simultaneously with the momentary value of the corresponding channel as indicated below.

1	100	°C
RR1-ABCD		Trend record

7.10 Message print specification

Explanation

- Message print is possible at the occurrence of any events.
- Up to 10 messages, each containing a maximum of 16 characters, can be registered by the user.
- Messages can be specified in numerals, alphabets and other special symbols.
Print colors (orange, red, blue, green, purple, black) and print positions (0 to 150mm) can also be specified.
- Message print timing can be specified for fixed time at the time of alarm, DI input and recording start.

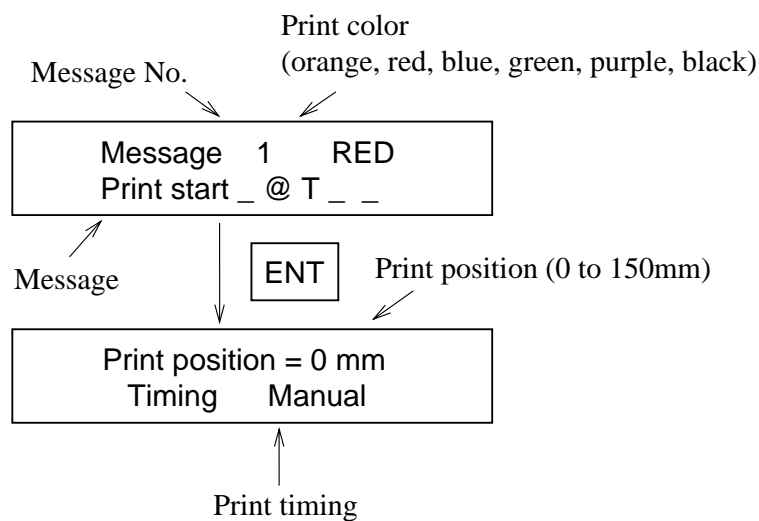

(1) Print color specification

- 1) Message print color is selected by \triangle , ∇ keys.
Press the ENT key after selection.
- 2) Print color comes in 6 kinds (orange, red, blue, green, purple, black).
- 3) When OFF is set in print color, no message is printed.

(2) Message specification

- 1) At the completion of print color specification, the first digit of message flashes. Press the \triangle , ∇ keys to display desired characters, then press the ENT key.
At this time, the second digit flashes. Specify the next desired characters in the same manner.
- 2) When '@Y', '@D' and '@T' are specified in message, "year", "month", "day" and "time" are printed (year is expressed in 3 characters, while month, day and time are expressed in 5 characters).
Example: Specification: @Y _ _ @D _ _ _ _ @T _ _ _ _
Print: '93 06/09 12:00
- 3) When '@1' to '9', '@A', '@B' and '@C' are specified in message, measured values (7 characters, without unit) corresponding to Ch1 to 6 are printed.
Example: Specification: Ch _ 1 _ @1 _ _ _ _ mV
Print: Ch1 -0.005 mV
- 4) When message contains more than 16 characters, up to 16 characters are printed.

(3) Print position specification

- 1) Message print position can be selected by the \triangle , ∇ keys. Press the $\boxed{\text{ENT}}$ key after selection.
- 2) The print range is 0 to 150mm. The size of each print character is 2mm.

Example: Print position for chart

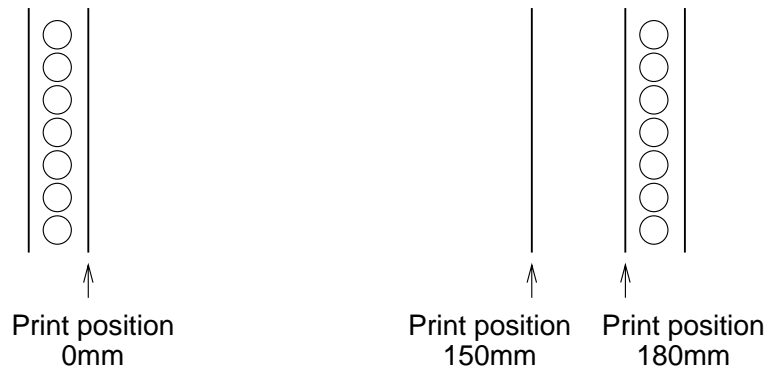

(4) Print timing specification

- 1) Message print timing can be selected by the " \triangle ", " ∇ " keys. Press the $\boxed{\text{ENT}}$ key after selection.
 - (a) Manual
 - When "manual" is selected, message is printed only in list print mode.
 - (b) Recording start
 - When "Record start" is selected, message are printed at the start of recording (record reset after power ON, and record start with REC key).
 - (c) DI 1 ON, DI 1 OFF
 - When DI 1 is selected, messages are printed at ON or OFF of DI 1 (terminals; 11 to 21). (When DI 1 is selected by message print timing, the recording start/stop function for ID 1 is not available.)
 - (d) DI 2 ON, DI 2 OFF
 - When DI 2 is selected, message are printed at ON or OFF of DI 2 (terminals; 12 to 22). (When DI 2 is selected by message print timing, DI 2 chart paper feed speed select function is not operating)
 - (e) DI 3 ON, DI 3 OFF
 - If DI 3 is selected, a message is printed when DI 3 (terminals 13 - 23) is ON or OFF. (The data print function of DI 3 does not work if DI 3 is selected at the timing of data print.)
 - (f) 00:00 to 24H
 - When "time" is selected, message is printed at the time of specification. It is printed at intervals of specified print time ("minutes" cannot be specified).

Example: Message print at intervals of 24 hours from 8:00

$\boxed{\text{Print position=0mm}}$

$\boxed{\text{Timing 8:00 to 2H}}$

Press the \triangle , ∇ keys for 8:00, then press the $\boxed{\text{ENT}}$ key.

Next, press the \triangle , ∇ keys for 2H, then press the $\boxed{\text{ENT}}$ key.

(g) ALM1 1 OFF

- When "alarm" is selected, message is printed at the time of ON or OFF of alarm of the specified channel.

Example: Message are print at ON of alarm of CH2.

Print position=0mm Timing ALM2 1 ON
--

Press the , keys for CH2, then press the key. Next press the , keys for LL alarm, then press the key. Next press the , keys for ON, then press the key.









(h) Recording termination

A message is printed when recording terminates.

7.11 List print-out specification

Explanation

- This is used for any of the parameter list print-outs, scale print-outs, test pattern print-outs, daily report lists, totalize lists and message print.
- The data display mode during printing of a list is the normal measurement display mode.
- If a list is printed during recording operation, analog trend recording is halted but it automatically restarts when print-out of the list ends.
In the case of message print, the data are printed without halting analog trend recording.

Key actuation (example)	Print-out of a test pattern is mode.	
Key operation	Explanation	Display
 	Press the SEL key several times to give the list selecting display.	
 	Press the △ , key to change to "List = 3" Test pattern.	
 	When the ENT key is pressed, printing starts. (To stop the print-out halfway, press the LIST key.)	





























- List =
1. Parameter list Example of print-out: See Section 11.3
 2. Scale print-out (Print-out for each channel is possible.)
..... Example of print-out: See Section 11.5.
 3. Test pattern Example of print-out: See Section 11.4.
 4. Daily report list Example of print-out: See Section 11.6.
 5. Sum data list Example of print-out: See Section 11.7.
 6. Message (Print-out for each No. is possible.)
..... Example of print-out: See Section 11.8.

Note: In the case of continuous recording, when a list print-out ends and analog trend recording restarts, the input value of immediately before the list print-out and the input value of immediately after the list print-out are recorded as continuous line.

7.12 Daily report specification

Explanation

- Instantaneous value data for each hour in each channel over a 24-hour period (max. 24 data items) and the average values, maximum values and minimum values of these lots of data items are printed out. (Printing time: about 48 minutes/24 channels for 24-hour setting)
(Analog trend recording cannot be performed during print-out.)
- The specification consists of specifying operation start time and operation end time on/off for automatic print-out and on/off for operation in each channel.
(Daily report operation is not performed for the channel set to OFF.)
- For execution, automatic print-out is set to ON. Print-out is executed at the operation end time.

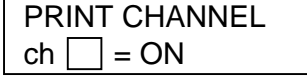
Key actuation (example)	On channels 1 to 6, automatic print-out is made from 9 to 16 o'clock.	
Key operation	Explanation	Display
 	Press the  key several times to display "Daily report function".	
 	Press the  key to display "ON" and press the ENT key.	
  	Next, use the  ,  keys to display "ON" for causing automatic print-out and press the  key. Use the  ,  keysto set the operation start time to "09" and press the ENT key Press the  ,  keys to set operation end time "16", then press the ENT key.	 
   	Use the  ,  keys to select channel No. 1 and press the ENT key. Next, use the  ,  keys to select ON and press the ENT key. Follow the same procedure to make setting for channel Nos. 2 to 6	

Note: Relations between operation start times and print-out times

When setup of daily report start time and end is changed, the print list immediately after the change is not compensated.

After the time setup was changed, turn off the daily report or integration (buffer clear) is possible. Then turn on again and wait for one day (until the end time on the next day).

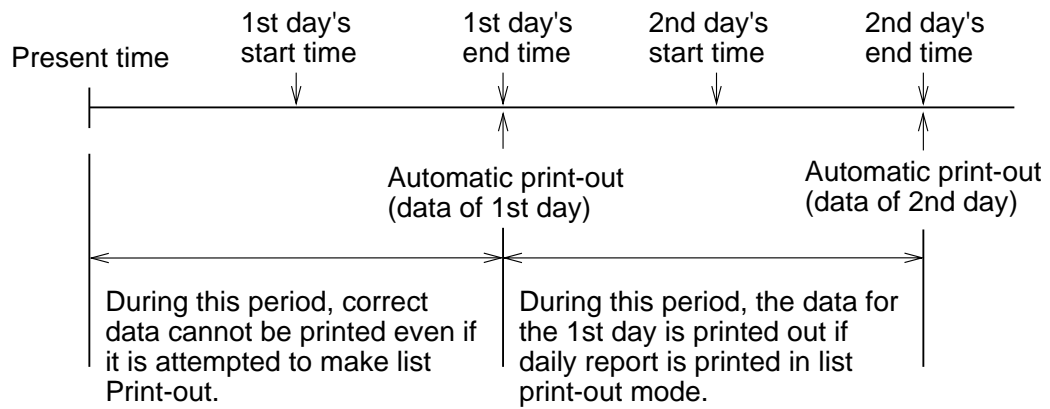











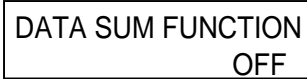















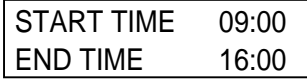

To print out a daily report for 24 hours, set the start time and end time.

7.13 Specifying totalize function

Explanation

- A maximum 24-hour lots of wholly totalizing value data in each channel (max. 24 data items) and the value of the sum totals of these lots of data items are printed out (Printing time: about 48 minutes/24 channels at 24 hour setting). (Analog trend recording cannot be performed during print-out.)
- The specification consists of specifying on/off for automatic print-out and on/off for operation in each channel.
(Totalize function is not available for the channel set to OFF.)
- For execution, automatic print-out is set to ON. The print-out is effected at the operation end time.

Key actuation (example)	Integration operation is performed from 9 to 16 o'clock and automatic print-out is effected for channel 1 to 6.	
Key operation	Explanation	Display
	Press the  key several times to display "Integration function".	
 	Press the  key to display "ON" and press the  key	
  	Next, use the  ,  keys to display "ON" for causing automatic print-out and press the  key. Use the  ,  keys to set the operation start time to "09" and press the ENT key Press the  ,  and "16" keys to set operation end time to 16:00, and press the ENT key.	 
   	Use the  ,  keys to select channel No. 1 and press the ENT key. Next, use the  ,  keys to select ON and press the ENT key. Follow the same procedure to make setting for channel Nos 2 to 6	

Note: The relations between integration operation start times and print-out times are the same as for the daily report function. See Section 7.12.

The input to the channel of integrating action ON is integrated in one second period, and it becomes 100% in an hour.

Example: When the input 0 to 100 L/h per hour:

The integrated value becomes 100 L/h after integration of 100 L per hour for one hour.

7.14 Setting the time

Explanation

Year, Month, Day, Hours, Minutes are displayed in that order going from the left.
The initial setting value is set to JST.

Key actuation (example)	Clock is 1 minute slow, (Correction of 35 minutes to 36 minutes)	
Key operation	Explanation	Display
SEL 	Press the SEL key several times to display "Clock".	DATA CLOCK '90 12/20 11:35
ENT	Since there is no change in the year, month, day or hours, press the ENT key to get the 'minutes' section flashing	DATA CLOCK '90 12/20 11:35
△	Press the △ key to set to "36"	DATA CLOCK '90 12/20 11:36
ENT	Match the time to the recorded time on the telephone, etc., and press the ENT key	DATA CLOCK '90 12/20 11:36

Reference 1: The clock is set to the current time in JAPAN at the time of shipment.

It is backed up by a lithium battery and so continues counting even if there is a power failure or the power is cut off. (The life of the battery is approximately 10 years (used at a normal temperature of 25°C).

Reference 2: The time is indicated on a 24-hour clock basis. The setting is 00 hours 00 minutes e.g.-23 hours 59 minutes.

Reference 3: Seconds are not displayed. The processing inside the clock is as follows.

When the minutes are set and the **ENT** key is pressed, a second counter is cleared to 0 and starts to count.



7.15 Clearing the ink monitor

Explanation

This is a function or warning and detection of ink dry-up.

Normally, this operation is not required but **always set to "Clear" when you replace the recording head with a new one**. If you forget to make the setting "Clear", operation continues from the previous count value, and so the ink dry-up warning-detection count is actuated and there is a constant ink dry-up warning-detection print-out.



Note: If you set to "Clear" other than times of replacement with new parts, there will be no "Ink empty" display when low level is reached.

Key actuation (example)	Clearing ink alarm.	
Key operation	Explanation	Display
<div style="border: 1px solid black; padding: 2px; display: inline-block;">SEL</div> 	Press the <div style="border: 1px solid black; padding: 2px; display: inline-block;">SEL</div> key several times to display "Ink alarm clear".	<div style="border: 1px solid black; padding: 5px; text-align: center;"> INK MONIT. CLEAR NO </div>
<div style="border: 1px solid black; padding: 2px; display: inline-block;">△</div> 	Press the <div style="border: 1px solid black; padding: 2px; display: inline-block;">△</div> key and change to "YES"	<div style="border: 1px solid black; padding: 5px; text-align: center;"> INK MONIT. CLEAR YES </div>
<div style="border: 1px solid black; padding: 2px; display: inline-block;">ENT</div> 	When the <div style="border: 1px solid black; padding: 2px; display: inline-block;">ENT</div> key is pressed the counter value is cleared. Display moves to the next parameter. Press the <div style="border: 1px solid black; padding: 2px; display: inline-block;">DISP</div> key to return to the measurement display	<div style="border: 1px solid black; padding: 5px; text-align: center;"> ILLUMINATION ON </div>

7.16 Turning the chart illumination lamp on/off (option)

Explanation

If the unit is provided with recording paper illumination (option), the lamp can be turned on and off by keyboard operation.

Key actuation (example)	Bolder turning chart illumination light off	
Key operation	Explanation	Display
<div style="border: 1px solid black; padding: 2px; display: inline-block;">SEL</div>  <div style="border: 1px solid black; padding: 2px; display: inline-block;">△</div>  <div style="border: 1px solid black; padding: 2px; display: inline-block;">ENT</div> 	<p>Press the SEL key several times to display "Internal illumination".</p> <p>Use the △ key to make it "OFF"</p> <p>When the ENT key is pressed, the lamp is turned off. Display moves to the next parameter.</p>	<div style="border: 1px solid black; padding: 5px; text-align: right;"> Display ILLUMINATION ON </div> <div style="border: 1px solid black; padding: 5px; text-align: right; margin-top: 10px;"> ILLUMINATION OFF </div> <div style="border: 1px solid black; padding: 5px; text-align: right; margin-top: 10px;"> Main chart speed 20mm/h </div>

8. MAINTENANCE - INSPECTION

Carry out periodic maintenance and inspection to keep the equipment in good condition.

Pay particular attention to the items noted below and make replacement with spares when necessary.

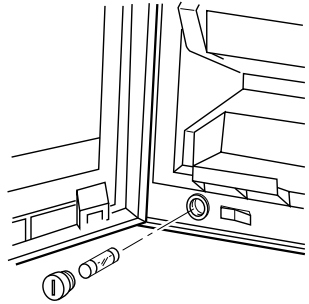
Inspection, Maintenance Items	Procedure
Recording head replacement	<p>The recording head is a consumable part. If there is no more ink, replace the head with a new one.</p> <p>Ink consumption varies depending on the contents of records, but writing for about 3 months is possible for 24 points recording at a recording paper speed of 25mm/h. If the ink dry-up warning display "Ink end" appears in the display section, refer to '5.2 Recording head installation' and replace the recording head with a new head. To get spares, quote the following type.</p> <p>Recording head type: PHZH1002</p> <p>Recording is possible for a little while after the warning display "Ink empty" appears. (There is about 10% of the total amount of ink remaining)</p>
Inspection of the recording head	<p>In normal conditions, there is no need for preventive maintenance of the recording head.</p> <p>However, in a high-temperature or very dusty environment, periodically wiping the nozzle surface prevents accumulation of dust and ink and so prevents nozzle blockage that is liable to be caused by such accumulation.</p> <p>Use the accessory 'ink absorption cloth' for wiping the nozzle surface.</p> <p>If a recording head is left unused for a long time without using the cap, ink may not be ooze out even if cloth is brought against the nozzle surface of the head. In this case, moisten the ink absorbent cloth with water, press it lightly against the nozzle surface for several seconds and then gently wipe the nozzle surface.</p>
Recording paper replacement	<p>In continuous operation at a paper feed speed of 25mm/h, the recording paper lasts about 31 days.</p> <p>When there is only a small amount of recording paper left, red characters are printed on the right-hand edge of the paper. When this happens, refer to Section 5.1 and replace the recording paper.</p> <p>When there is no more recording paper, recording operations stop and 'Chart end' is displayed in the display section.</p> <p>To get supplementary paper, quote the following type.</p> <p>Recording paper type: PEX00BL1-1000B</p>
Replacing the fuse	<p>If the fuse blows, turn the power supply off and then investigate the cause and replace. You will see the fuse on lower left when the front flap is opened.</p> <p>Use a straight blade screwdriver to turn the fuse holder anticlockwise and detach it. Replace with an accessory 250 V/1A tubular fuse.</p> 

Replacing the battery

- If a "Battery end" display appears in the display section replace the batteries.
[Note that turning the power off while a 'Battery end' display is on may result in erasure of specified data.]
- Proceed with the power switched on. Open the front flap and follow the procedure described below to replace the batteries.

Step 1

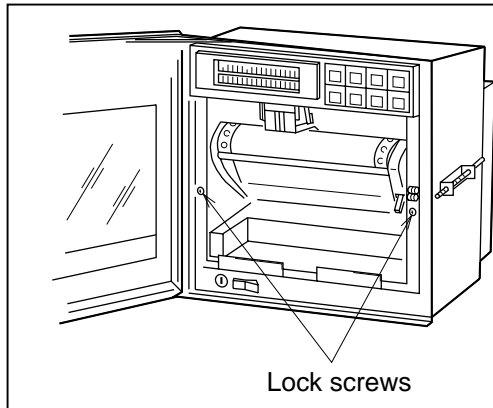

Loosen (anticlockwise) the lock screws on the left and right and remove them.

Step 2

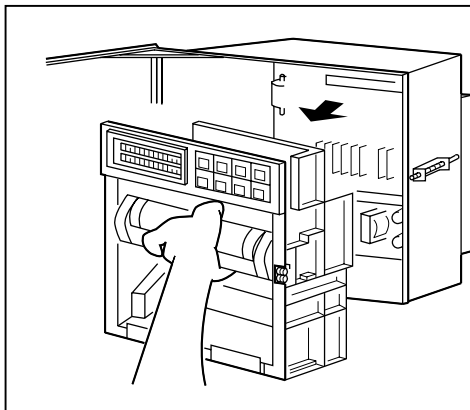

Grip the paper feed frame and pull it firmly towards you.
This detaches it from the main unit.

Step 3

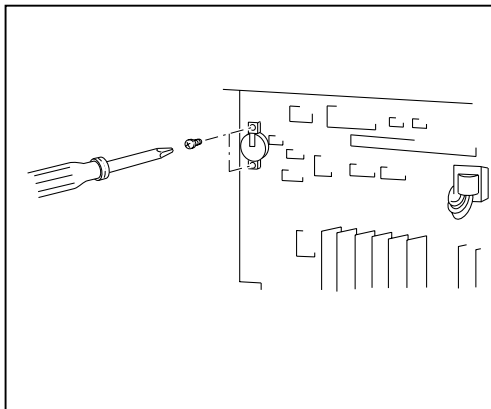

Use a plastic screwdriver to loosen (turning anticlockwise) the battery unit that is mounted on top of the internal printed circuit board and remove it.

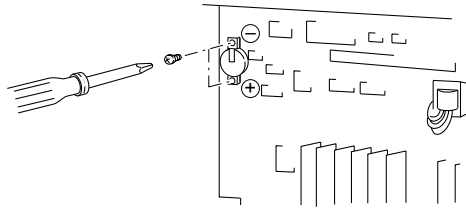
Step 4

Use a plastic screwdriver to mount a new battery unit. When doing this be careful to get the battery polarity right. Upper: ⊖

Lower: ⊕

Battery part No.: TK7G8473P1

Step 5

- After completing the battery replacement, return the main unit to its original state.
- Always tighten the lock screws on the left and right.
- Check that 'battery end' display in the display section has gone out.

Reference: Battery life

- The battery life is about 10 years at normal temperature.

Flourescent lamp replacement

When the lamp remains OFF, dark or blinks, it needs to be replaced.

- Turn OFF the power.
- Open the front door and replace the lamp using the following procedures.

Step 1

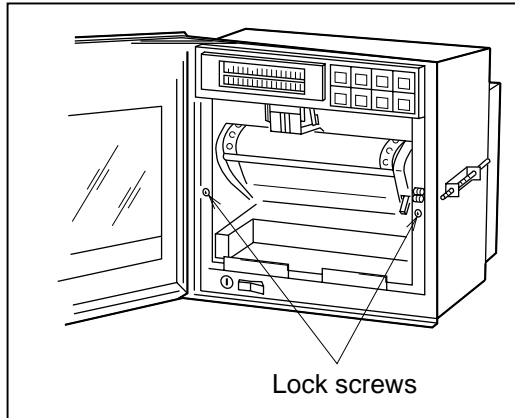

Loosen (anticlockwise) the lock screws on the left and right and remove them.

Step 2

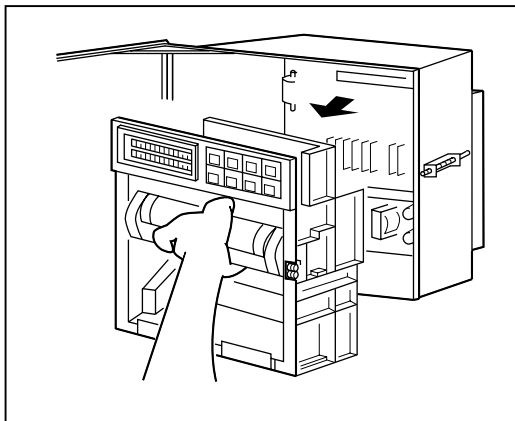

Grip the paper feed frame and pull it firmly towards you.
This detaches it from the main unit.

Step 3

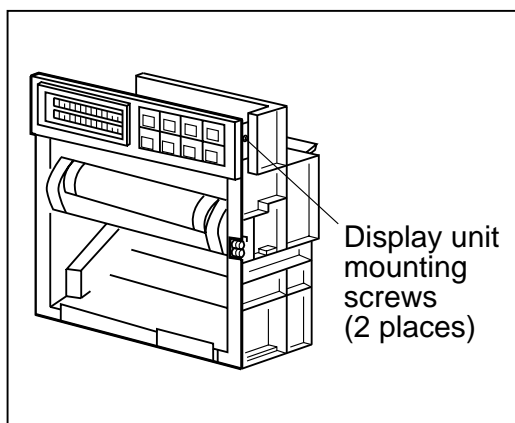

Remove the left and right screws on the display unit. Then, remove the display unit from the main unit.

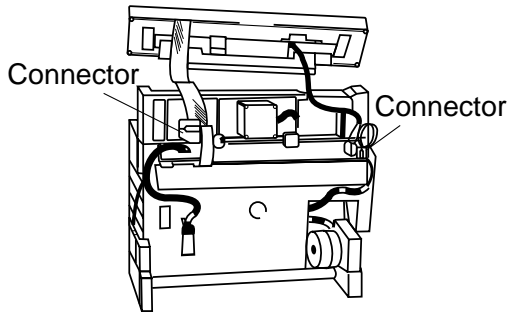
Step 4

Remove the connectors (2 places) connecting the display unit to the main unit.

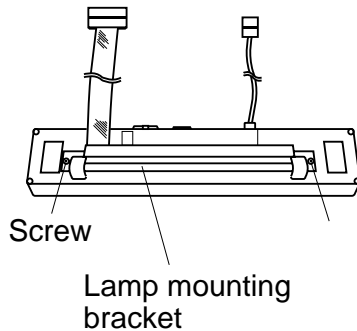
Step 5

Loosen the mounting brackets on both sides of the fluorescent lamp at the rear of the display unit. Remove the brackets from the display unit.

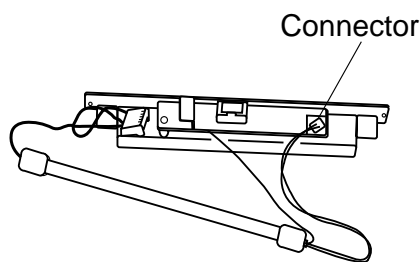
Step 6

Remove the lamp from the mounting brackets, then pull off the connector by pushing up the tab on the connector between the lamp and the inverter.

Step 7

- Set a new lamp (with cable and connector).

It should be set in the order of **Step 6** → **Step 5** → **Step 4** → **Step 3**
→ **Step 2** → **Step 1** .

Step 8

- Turn ON the power and check that the lamp lights up.
- The replacement lamp (with cable and connector) should be ordered specifying the following Part No.
Part No. PHZL8001

Reference: Life of lamp

- About 1 year (continuous)

9. APPLICATION FUNCTIONS

This section gives some explanations and information about following functions.

- (1) Print/recording adjustment
- (2) Zero/span adjustment for analog trend recording position
- (3) Alarm latch and totalize print-out settings
- (4) Shift of measured values
- (5) Preparation of unit
- (6) External output of recording error

Any of the above adjustments are done with software so operation is quite simple.

9.1 Adjustment of backlash

Explanation

Make adjustment when character kink and/or disturbance of record (round trip difference) occurs.
Connection of calibration equipment is not required for this adjustment.

Operation

- (1) Stop the recording operation by pressing the **REC** key.
- (2) Have parameter "INK ALARM CLEAR" displayed by pressing the **SEL** key.
- (3) Press the **SEL** key while the **FEED** key is kept pressed. The parameter for calibration will be displayed.

ADJUST HEAD
BACKLASH=3

This is display of adjustment of print-out and recording.
2, 3 or 4 is usually displayed.

<Example>

Have BACKLASH=4 displayed by pressing the **△** key.

Press the **ENT** key.

Return to the display mode by pressing the **DISPLAY** key.

(See section 6.3 for the test pattern printing method.)

If improvement of character kink is insufficient, repeat the operation of step (2) and subsequent and increase the value of BACKLASH = □.

If character kink has become worse, repeat the operation of step (2) and subsequent and decrease the value of BACKLASH = □.

Obtain the best condition by repeating.

<Note>

The value of BACKLASH can be changed from 0 to 9.

The standard value is 3. Normal print-out and recording are usually obtained in the range of 2 to 4.

9.2 Zero/span adjustment for analog trend recording position

Explanation

The zero point (0% point) and span point (100% point) for analog trend records on the recording paper are adjusted. There is no need to connect a calibration instrument for this adjustment.

Operation

- (1) Press the **REC** key to stop recording operation.
- (2) Press the **SEL** key to bring up a display of the parameter 'Ink alarm clear'.
- (3) Press the **SEL** key while holding the **FEED** key depressed. This effects a shift to a display of parameters for calibration. The first display shows manufacture's test parameters, ignore this and press the **SEL** key.

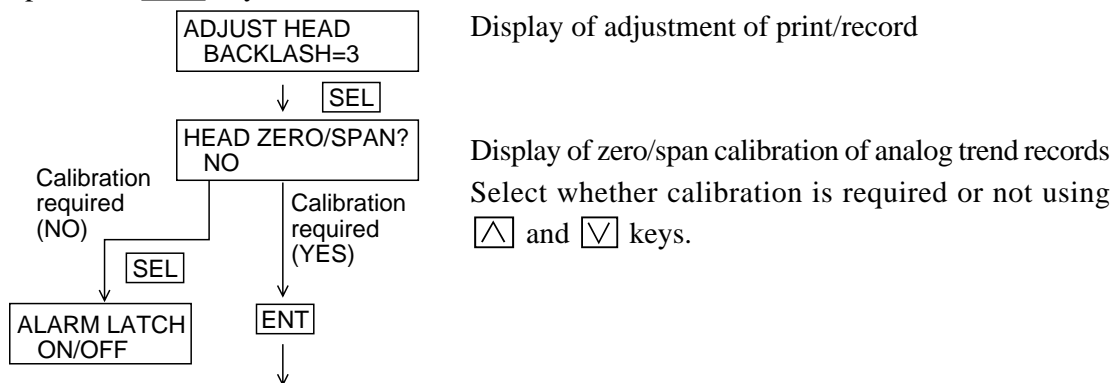

The recording head moves and records a black straight line at the zero point (0% point).
If the place where this line is recorded is not at the 0% point of the recording paper, make an adjustment.

Pressing the **△** key moves the recording point to the right.

Pressing the **▽** key moves the recording point to the left.

After bringing the recording point to the zero point, press the **ENT** key.
This completes zero point calibration.

The recording head moves to the 100% side and records a black straight line at the span point (100% point).

If the place where this line is recorded is not at the 100% point of the recording paper, make an adjustment.

Pressing the **△** key moves the recording point to the right.

Pressing the **▽** key moves the recording point to the left.

After bringing the recording point to the span point, press the **ENT** key.
The recording head moves and recording stops. End of span point calibration.

- You can switch to the display mode by pressing the **DISPLAY** key.

Note: The display becomes "data print" or "list print" if a list print request occurs during zero/span of the head. List print should not be requested during zero/span adjustment.

9.3 Setting of alarm latch and integrated value print-out

(1) Setup of alarm latch

Explanation

- Alarm display output is retained even if alarm is OFF.
- Latch OFF and alarm OFF are printed at OFF of alarm latch function or at input of DI3 (terminal 13 to 33).
- When the alarm latch function is set to ON, instantaneous value list is not printed at input of DI3.

(2) Setup of integrated total value print

Explanation

- When integrated total value print is ON, the total value only is printed at the time of printout of the integrated list.
- Typical print

Operation

Example: Alarm latch function ON

- (1) Press the **[SEL]** key to display parameter "Ink Alarm Clear".
- (2) Press the **[SEL]** key while pressing the **[FEED]** key to display calibration parameter.
- (3) Press the **[SEL]** key to display "Alarm latch" image.

ALARM LATCH	OFF
TOTAL PRINT	OFF

- (4) Press the **[△]** key to change from OFF to ON.
- (5) Finally, press the **[ENT]** key.
- (6) Change Total print OFF to ON by pressing the **[△]** key.
- (7) Terminate setup by pressing the **[ENT]** key.

*By pressing the **[DISPLAY]** key, the recorder is changed over to display mode.

9.4 Setting of PV shift

(1) PV shift function

- It is possible to arithmetically operate the measured value and to record the display the result.
- Set the inclination and shift value for PV shift arithmetic operation.

The conversion graphs after execution of shift arithmetic operation and inclination arithmetic operation are indicated below.

- Shift arithmetic operation

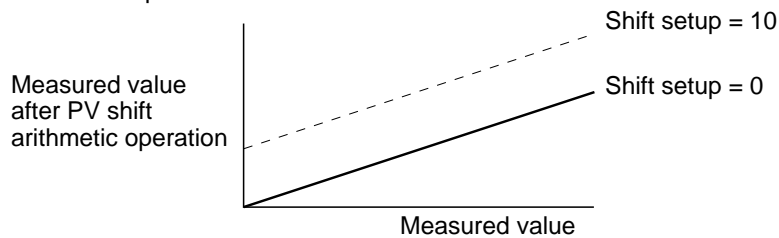

- Gain arithmetic operation

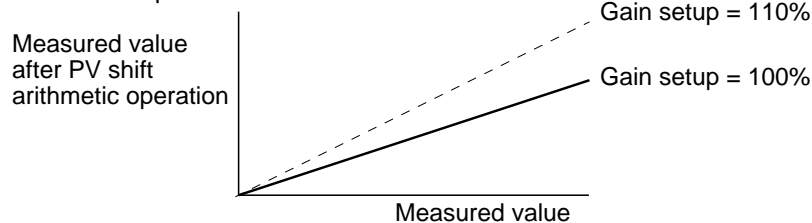

- PV shift arithmetic operation is of the following expression.

$$P' = AP + B$$

where; P': Measured value after PV shift arithmetic operation

P: Measured value

A: Gain (0.01 to 327.67%)

B: Shift value (-32767 to 32767 engineering value; decimal point varies by input type)

- The measured value after PV shift arithmetic operation is limited so that it is located within the recording range settable range of the input type set for each channel.
- When the input type is changed or when ON/OFF of the scaling function is made, the PV shift set value of the subject channel is cleared.
- The PV shift set value is not copied even when the set value is copied by making use of the setup copy function.

<Setting screen>

Measured value (changes when the PV shift set value is changed.)

Screen 1

ch1 shift	-10.000
0.00V	



Shift value (initial value 0)

Screen 2

ch1 Gain	-10.000
100.00%	



Gain (initial value is 100.00%)

- The PV shift function should not be used when logarithmic arithmetic operation is set.

9.5 User definable unit

Explanation

The unit may be created using numerals, alphabetic letters, etc.
Up to 7 digits can be set, and units of 12 types can be registered.

Operation

Example: To create unit kgf/cm² for code A = 2, B = 10.

(1) Have parameter "Ink alarm clear" by pressing the **[SEL]** key.

(2) Press the **[SEL]** key while pressing the **[FEED]** key.

Transition to display of parameters for calibration occurs.

(3) Have the "Unit" screen displayed by pressing the **[SEL]** key.

Unit: A=1 B=10

(4) Set unit registration code A = 2 using **[^]** and **[v]** keys and then press the **[ENT]** key.
(A = 1 - 12 may be set. B = 10 is fixed.)

(5) The first digit of the unit begins to flicker. Set "K" using **[^]** and **[v]** keys and then press the **[ENT]** key.

(6) The second digit of the unit begins to flicker next.

Make setup in the same manner.

Unit: A=2 B=10
kgf/cm²

(7) The flickering digits advances sequentially, and setup terminates when the figure of A = **[2]** begins to flicker.

*Switching to the display mode can be made by pressing the **[DISPLAY]** key.

9.6 Setting of record error external output

Explanation

- Relay output to the exterior is made on occurrence of chart end, battery end, carriage error or ink end.
- Relay output to the exterior also occurs when an alarm occurs and when a recording error occurs, if output setup is made for the relay, which is the same as the relay No. specified by "Alarm setup".

Operation

- (1) To send output to relay 6 on occurrence of ink end:

CHART END	
OFF	ALM0

- (2) Have ink end displayed by pressing and keys.

INK END	
OFF	ALM0

- (3) Change OFF to ON by pressing the key.

- (4) Set ALM6 by pressing the key.

INK END	
OFF	ALM0

- (5) Terminate setup by pressing the key.

9.7 Calibration of measured value

Explanation

Normally, no adjustments are required, except when measured value displayed is excess of the guaranteed value. With calibration input signal applied, adjustment is made automatically with software. Apply a correct calibration input to the object channel.

Note: Use of incorrect calibration input signal will results in wrong operation.

Operation

- (1) Press the REC key to stop recording.
- (2) Press the SEL key to display parameter "Ink Alarm Clear".
- (3) Press the SEL key while pressing the FEED key to display calibration parameter.

ADJUST HEAD
BACKLASH=3

Print/record adjustment display

HEAD ZERO/SPAN?
NO

Press the **[SEL]** key

Zero/span calibration display for analog trend record.

ALARM LATCH OFF
TOTAL PRINT OFF

Press the **[SEL]** key

Press the SEL key while pressing the **[FEED]** key

ADJUST Ch
ZERO SPAN

Zero/span calibration display for measured value.

Note: To halt zero/span calibration for measured value, press the **[DISPLAY]** key without pressing **[ENT]** key (changing over to display mode).

- (4) Press the **[△]** and **[▽]** keys to select channels to be calibrated.
Ch1 to Ch12 = DC voltage input, resistance bulb input, thermocouple input Ch13 to Ch16 = For maker test. Do not use.

↓ Press the **[ENT]** key

- (5) *1 **[Apply 0% input]**

*1 0% point zcalibration input signals are shown below.
Voltage input : 0mV or 0V
Thermocouple input : 0mV
Resistance bulb input (Pt, JPt) : 100Ω

[ENT]

Press the **[ENT]** key. Zero point calibration is started automatically.

↓

(Press the **[ENT]** key after 0% input (*1) is applies.)

Zero point calibration end... "OK" is displayed and recorder is set in span calibration standby mode.

- (6) *2 **[Apply 100% input]**

*2 100% point calibration input signals are shown below.
±50mV : 50mV Resistance bulb
±500mV : 500mV (Pt&PJt): 324.26Ω
±5V : 5V
±50V : 50V
Thermocouple : 50mV (Room temperature compensation is not required)

[ENT]

Press the **[ENT]** key. Span point calibration is started automatically.

↓

(Press the **[ENT]** key after 100% input (*2) is applies.)

SPAN point calibration end..... "OK "is displayed.

↓

When other channels are to be adjusted, press **[△]** and **[▽]** keys for set the channels.

- (7) Press the **[DISPLAY]** key. The recorder is changed over to display mode, indicating that calibration is completed.

Note: There are cases where keys other than the FEED key become invalid when a list print request or message print request is made during input adjustment. Perform input adjustment in the state where no list print request or message print request will occur.

9.8 Change of record color

Explanation

- The recording and print color of each channel is changed.

Operation

- Have the calibration screen displayed by the operation described in section 9.7.

ADJUST Ch
ZERO SPAN

The recording color change screen appears when the **SEL** key is pressed.

Ch
COLOR = ORANGE

Select the channel to be changed using **▲** and **▼** keys, and then press the **ENT** key.

Select the recording color by pressing **▲** and **▼** keys. Terminate setup by pressing the **ENT** key.

Ch
COLOR = GREEN

9.9 Language selection

Explanation

- The characters for display and print-out with this machine may be selected out of the following three languages.

English German French

Operation

LANGUAGE
ENGLISH

The display is switched when the **▲** key or the **▼** key is pressed while the message shown on the left is displayed. Select a display language and then press the **ENTER** key. Display and print-out in the selected language will be made.

10. TROUBLESHOOTING

If the unit does not function properly, check what is wrong and refer to the following table to see what action to take.

For complicated trouble, consult with our service engineer.

State	Points to check	Action to take
Does not move at all	(1) Is the power supply terminal connection correct ?	Connect correctly
	(2) Is power being supplied properly ?	Effect proper supply
	(3) Has the fuse blown ?	Replace the fuse
Keys do no work	(1) Have you caused data print-out by pressing the LIST key ?	Wait until the end of print-out or press the LIST key to stop the print-out
	(2) Is a parameter list, scale print-out, test pattern, daily report list or integration list print-out in progress ? <ul style="list-style-type: none"> • "The following keys are inoperative during data print-out and list print-out. (See section 2) RECORD DISPLAY SELECT 	
	(3) Is Chart end, Carriage alarm being displayed ? <ul style="list-style-type: none"> • The SELECT key is inoperative when the above state displays are produced. 	Eliminate the displayed state. (Put recording paper in, Check the carrier fault.)
The record swings over to the 0% side or the 100% side	(1) Is the input signal wiring correct ?	Correct the wiring
	(2) Is the record range correct (⊖, ⊕ sides) ?	Set a correct range
	(3) Has a thermocouple or resistance bulb wire broken ? (If wire breakage occurs, there is a burn-out display and a swing over to the 100% side.)	Replace the thermocouple or resistance bulb.
The record zero/span point is out of position	Refer to Section 9.2 and adjust. Always make the adjustment of Section 9.2 after replacing the recording head.	
There are large errors	Do the input signals match the specification ? (Signal source resistance, etc.)	Bring them to the proper specification.
The data display goes to 'Over', 'Under' or 'Error'	(1) The specification of the input signal setting pins and the input signal type specification made using the front panel do not agree	Adjust so that they agree
	(2) Is there supply of excessively large or excessively small input ?	Effect supply of correct input
The display goes to 'Carriage Alarm'	Refer to Section 6.11	

State	Points to check	Action to take
Ink does not come out even though there is no 'Ink out' display or the ink colours are blurred.	Carefully note the points described on page 5-7 in relation to the recording head (i.e., the notes on storage and avoiding imposition of vibration or impact). If ink does not flow properly, take the action described on the right. If this has no effect, the recording head must be replaced.	Refer to "Note 6: If the ink is not sprayed" on page 5-8. When the working environment is 15°C or less, perform print-out of "record" or "test pattern" after a period of several minutes has elapsed since the recording head was mounted. (The recording head has a built-in heater.)
Characters are deformed.		
The record colours are wrong.		
Ink does not flow.	Is the head inserted into the carrier sufficiently?	Push the head on properly. (Refer to Step 6 of Section 5.2)
Trend record or characters turn to double-line (round trip difference appears) or characters are disordered.	1) Wipe the carriage drive shaft with dry, clean cloth. 2) When this procedure 1) is not effective, follow Section 9.1 "Print/record adjustment".	

11. EXAMPLES OF RECORDS AND PRINT-OUTS

Note: In the case where the chart speed is 51 mm/h or more (chopper bar recording type), there are no periodic print-outs, scale print-outs (but print-out can be made manually; see Section 7.11) message print-out, alarm print-out, burn-out print-outs or ink end print-outs.

11.1 Periodic print-outs, scale print-outs

(1) Periodic print-outs:

Time lines, dates, times, the chart speed and the measured values for each channel are automatically printed out at set intervals in correspondence to the chart speed.

(There is print-out only if periodic print-out is set to "ON". See Section 7.6.)

(2) Scale print-outs:

Scale lines, figures and units are automatically printed out at set intervals in correspondence to the chart speed.

(There is print-out only if scale print-out is set to "ON". See Section 7.6.)

Example of 12 points records

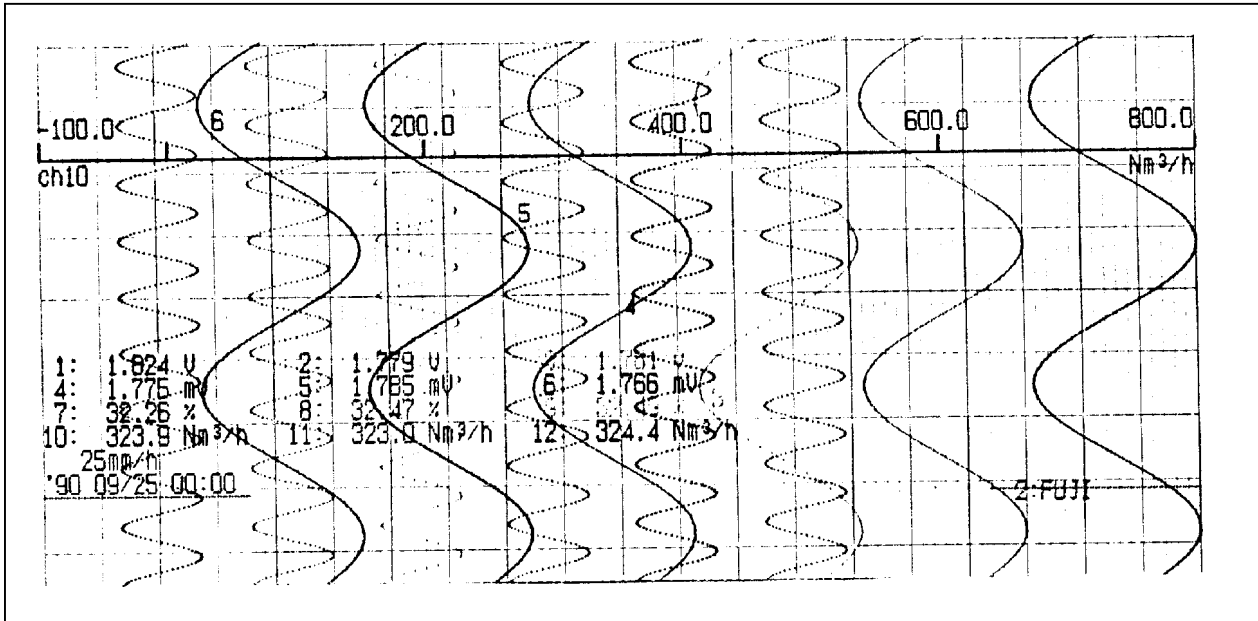

11.2 Digital print-out (instantaneous values)

Pressing the **LIST** key effects immediate print-out of current values. (See Section 6.4 (2))

Year, month, day, time

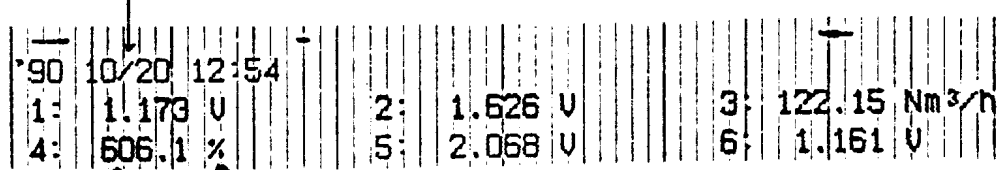

↑ Measured value ↑ Engineering units
 Channel No.

Note: "—" (hyphens) are printed for a channel for which skip has been set.
 Furthermore, no engineering unit is printed.

11.3 Parameter list print-out

The specified contents of parameters are all printed out together on the recording paper. (See Section 7.10)

'93/06/21 14:17												
TREND MODE												
MAIN CHART SPEED		300 mm/h			REC. FORMAT			Zone				
SUB CHART SPEED		100 mm/h			PERIODIC PV LIST			On				
LOGGING INTERVAL		10 min			SCALE PRINT			On				
ch	TAG	INPUT TYPE	MEAS. RANGE		SCALING RANGE		REC. RANGE		UNIT	FILTER		SUBT ch
			MIN	MAX	MIN	MAX	MIN	MAX		(S)	ROOT	
1	CHANNEL1	SV	-5.000	5.000	-5.00	5.00	-100.00	100.00	ABCDEFG	0	Off	0
2	CHANNEL2	SV	-	-	-	-	-5.000	5.000	V	3	Off	1
3	channel13	K	-	-	-	-	500.0	0.0	°F	0	Off	0
4	Channel14	SV	1.000	5.000	1.00	300.00	100.00	-100.00	kVar	200	On	0
5	channel15	SV	-5.500	5.500	0.0	1000.0	0.0	1000.0	Nm ² /h	5	Off	1
6	Channel16	SV	-	-	-	-	0.000	5.000	V	0	Off	0
ALARM												
ch	LL	ALM	L	ALM	H	ALM	HH	ALM	RL	ALM	RH	ALM
1	-		-4.00	5	-1.50	4	2.00	1	-		-	
6	-		-		-		-		0.020	9	0.050	4

11.4 Test pattern

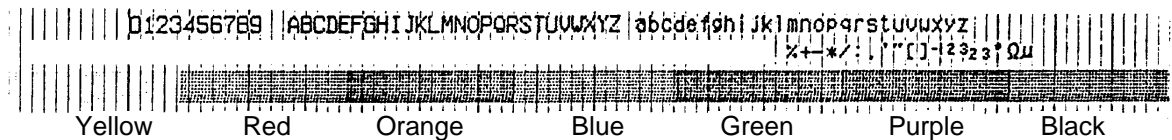

11.5 Scale print-outs

The scales of specified channels are printed. (See Section 7.11)

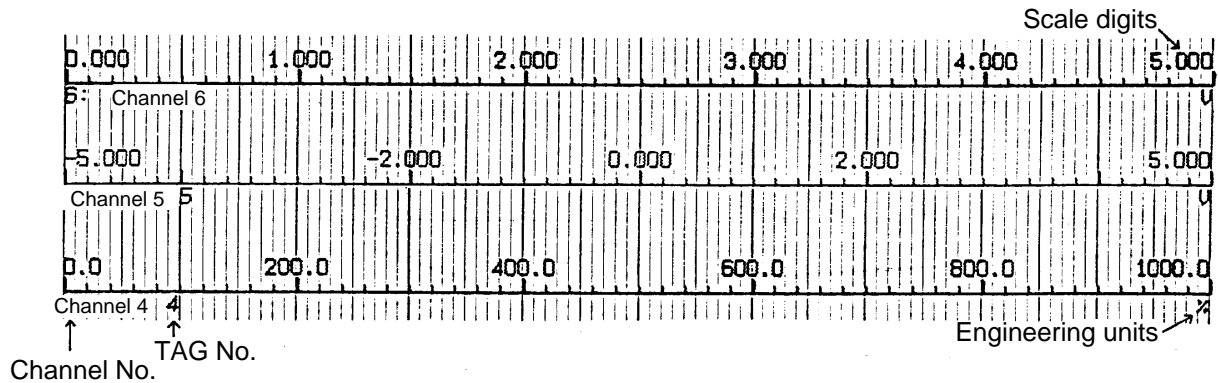

11.6 Daily report print-out

This consists of print-out of the data for a max. 24-hour period (max. 24 data items in hourly units) for specified channels.

The maximum, minimum and average values of the instantaneous values on the every full hour from the daily report start time to the daily report end time are printed out. (See Section 7.12 for the specification procedure.)

Month day Time		Daily report list					
		90	10/20	16:06			
		ch1	ch2	ch3	ch4	ch5	ch6
		Channel 1	Channel 2	Channel 3	Channel 4	Channel 5	Channel 6
TAB Units		V	V	Nm ³ /h	%	V	V
09/02	00:00	2.617	3.781	14.00	390.6	0.999	2.593
09/02	01:00	1.657	2.982	280.74	470.5	1.003	1.640
09/02	02:00	4.993	2.180	130.79	550.7	1.106	4.945
09/02	03:00	1.959	1.380	43.57	630.8	4.507	1.940
09/02	04:00	2.258	4.580	298.02	519.2	4.382	2.234
09/02	05:00	4.934	3.781	80.65	390.6	1.000	4.888
09/02	06:00	1.435	2.981	86.03	470.6	1.003	1.421
09/02	07:00	2.945	2.180	296.98	550.7	1.106	2.915
09/02	08:00	4.637	1.380	39.30	632.5	4.517	4.594
09/02	09:00	1.100	4.579	137.01	519.3	4.380	1.089
09/02	10:00	3.644	3.779	277.54	390.8	1.000	3.607
09/02	11:00	4.133	2.978	11.46	470.9	1.003	4.094
09/02	12:00	1.003	2.177	189.63	551.0	1.107	0.992
09/02	13:00	4.260	1.378	242.47	642.2	4.555	4.219
09/02	14:00	3.491	4.577	1.14	519.5	4.373	3.458
09/02	15:00	1.153	3.778	236.65	390.9	0.999	1.140
09/02	16:00	4.720	2.978	196.24	470.9	1.004	4.674
09/02	17:00	2.791	2.175	9.10	551.2	1.107	2.765
09/02	18:00	1.533	1.376	273.83	646.9	4.565	1.518
09/02	19:00	4.969	4.576	143.86	519.6	4.371	4.920
09/02	20:00	2.113	3.775	34.72	391.2	0.999	2.093
09/02	21:00	2.096	2.975	295.39	471.2	1.003	2.075
09/02	22:00	4.971	2.174	92.43	551.3	1.109	4.925
09/02	23:00	1.546	1.374	74.82	656.3	4.601	1.531
	MAX	01:59	11:16	04:35	00:10	00:12	01:59
	MIN	5:002	5:000	299.88	876.6	4.967	4.954
	Average	1.000	1.006	1.00	356.7	0.999	0.989
		2.956	2.911	145.27	514.5	2.324	2.927

Channel No. ———
TAG No. ———
Working units ———

Instantaneous values
In each channel

Time of occurrence of maximum value ———
Maximum value ———
Time of occurrence of minimum value ———
Minimum value ———
Average values of data in list ———

Note 1: The following print is made on occurrence of an input error.

- Under-range: Minimum value of recording range
- Over-range: Maximum value of recording range
- Error: Maximum value of recording range
- Burn-out: "—" (hyphens)

11.7 Data sum list print-out

This consists of print-out of the data for a max. 24-hour period (max. 24 data items in hourly units) for specified channels.

The integrated values for each hour and the totals of the integrated values from the integration start time to end time are printed out (See Section 7.13 for the specification procedure.)

Month day Time		Integration values for 1 hour from 01.00 to 0.200						Channel No.
Integration list		ch1	ch2	ch3	ch4	ch5	ch6	TAG No.
90 10/20 16:23		Channel 1	Channel 2	Channel 3	Channel 4	Channel 5	Channel 6	Working units
		V	V	Nm ³ /h	%	V	V	
09/02 02:00		2.876	3.047	129.08	533.6	2.329	2.848	
09/02 03:00		2.819	3.135	174.81	524.8	2.218	2.791	
09/02 04:00		3.345	2.990	142.53	517.6	1.920	3.313	
09/02 05:00		2.772	2.870	135.46	538.3	2.196	2.744	
09/02 06:00		2.932	2.958	176.22	542.8	2.332	2.904	
09/02 07:00		3.314	3.046	134.55	533.7	2.329	3.282	
09/02 08:00		2.697	3.136	143.62	524.7	2.218	2.671	
09/02 09:00		3.053	2.991	174.41	517.5	1.919	3.023	
09/02 10:00		3.243	2.869	128.46	538.5	2.196	3.212	
09/02 11:00		2.660	2.957	152.70	542.5	2.332	2.633	
09/02 12:00		3.168	3.048	169.62	533.6	2.329	3.137	
09/02 13:00		3.143	3.136	125.11	524.7	2.217	3.113	
09/02 14:00		2.664	2.989	161.49	517.6	1.920	2.638	
09/02 15:00		3.263	2.870	162.49	538.6	2.197	3.232	
09/02 16:00		3.026	2.959	124.92	542.5	2.332	2.996	
09/02 17:00		2.711	3.047	166.85	533.6	2.329	2.684	
09/02 18:00		3.324	3.135	153.81	524.8	2.216	3.292	
09/02 19:00		2.904	2.990	127.88	517.5	1.920	2.876	
09/02 20:00		2.794	2.869	173.96	538.5	2.197	2.767	
09/02 21:00		3.346	2.959	144.71	542.5	2.332	3.313	
09/02 22:00		2.796	3.046	133.67	533.7	2.329	2.769	
09/02 23:00		2.902	3.137	176.15	524.6	2.215	2.874	
09/03 00:00		3.326	2.989	136.40	517.7	1.921	3.293	
09/03 01:00		2.712	2.870	141.47	538.6	2.198	2.686	
Total		71.790	72.043	3592.37	12742.5	52.641	71.091	

Total of data in list

Note 1: The following print is made on occurrence of an input error.

- Under-range: Minimum value of recording range
- Over-range: Maximum value of recording range
- Error: Maximum value of recording range
- Burn-out: 0

11.8 Message print (manual print)

Specified message is printed. (Refer to Section 7.10)

Record starts 11:40	Error occurs 06/03
---------------------	--------------------

11.9 Logging

The instantaneous value of the various channels are printed out at set intervals of time.
(See Section 7.6 (1).)

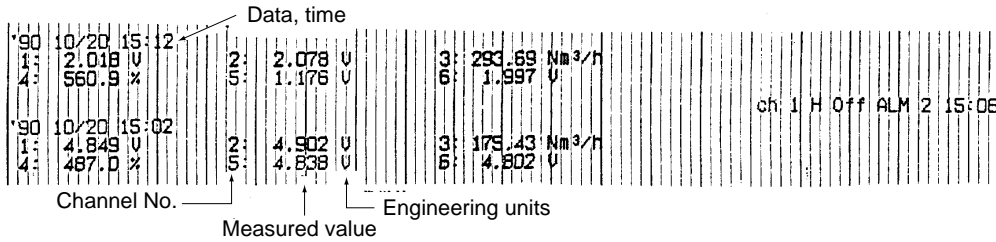

11.10 Alarm print-outs

When an alarm is detected and cancelled, the time of detection and cancellation, the channel No., the type of alarm and the relay No. are printed on the right-hand side of the recording paper.

On detection: print-out colour red, on cancellation: print-out colour: black

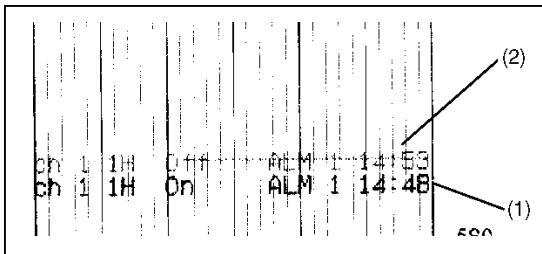

- (1) H alarm occurred with Ch 1 No. 1. Relay No. 1, occurred time 14:48.
- (2) H alarm of Ch 1 No. 1 was canceled. Relay No. 1, canceled time 14:56.

11.11 Burn-out print-out

If a burn-out occurs, the channel No. burn-out and time of occurrence are printed in red at the right-hand edge of the recording paper.

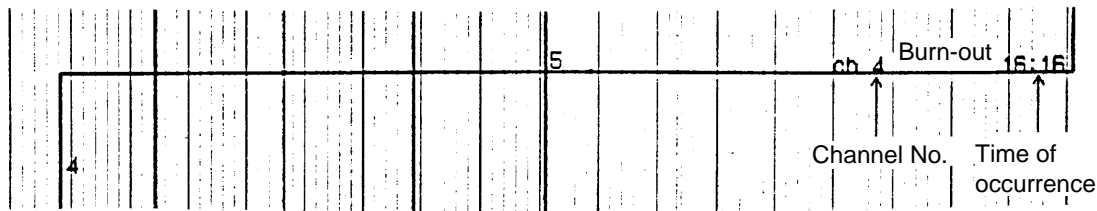

11.12 Ink dry-up warning print-out

When only about 10% or less of an ink remains, 'Ink Empty' is printed out in the color of this ink on the right-hand side of the recording paper.

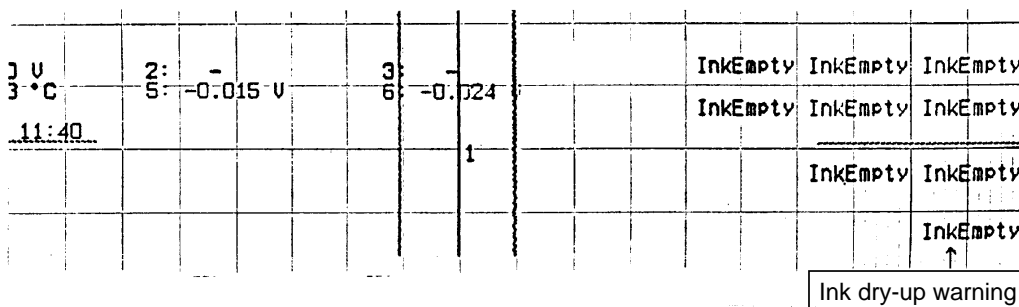

11.13 Record start mark

When recording starts, a record start mark is printed at the left-hand edge of the recording paper (outside the 0% scale line).

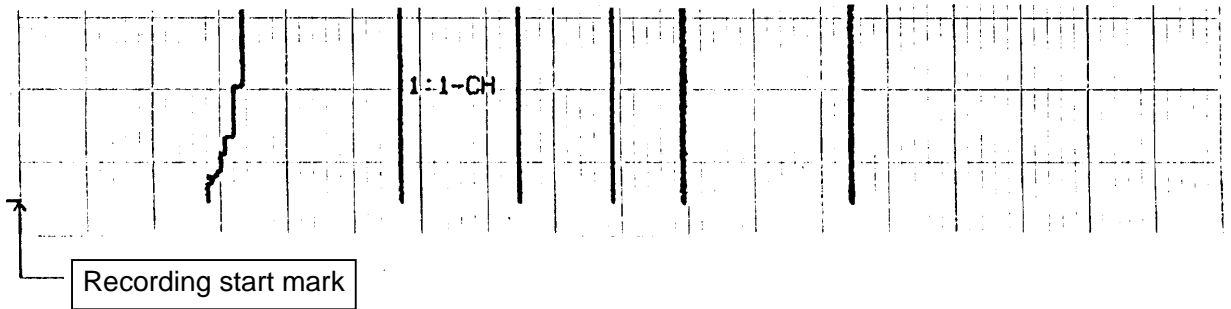

11.14 Chart speed change mark

If a change in the speed of the recording paper is ordered, a chart speed change mark is printed at the left-hand edge of the recording paper (inside the 0% scale line).

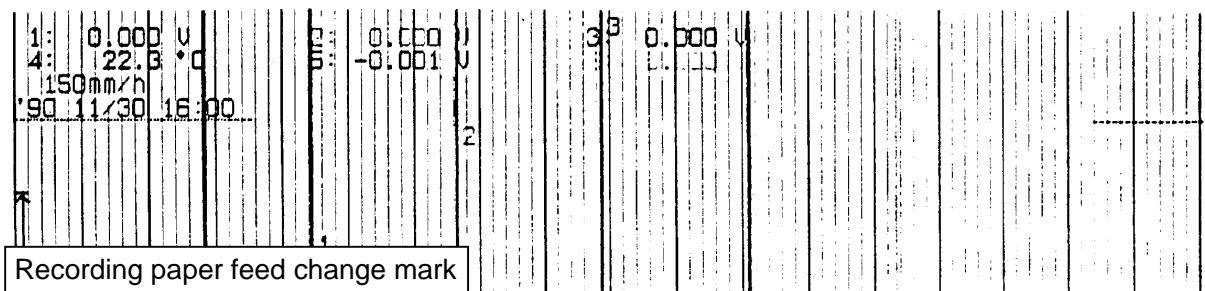

11.15 Auto-range change mark

If the auto-range function changes the range during recording, a change mark is printed at the right-hand edge of the recording paper.

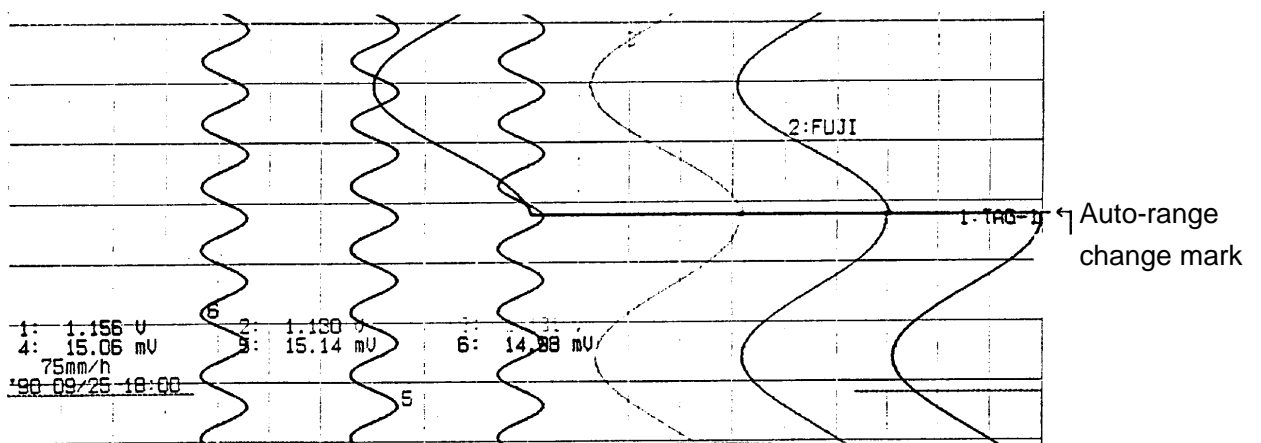

12. SPECIFICATION

Input Section

- Number of input points: 24 points dot record
- Input signals: Thermocouple input B, R, S, K, E, J, T, N, W, L, U, PN
Resistance bulb input Pt 100, JPt100 (JPt means special input in Japanese)
DC voltage input 50mV range, 500mV range, 5V range, 50V range
Direct current input 4 to 20mA DC, 10 to 50mA
(Note: Terminal section to be fitted with separately sold 10Ω shunt resistor and range to be made 500mV.)
Maximum allowable input voltage:
Thermocouples, resistance bulbs, DC voltage (50mV, 500mV range): ±10V
Direct current input (5V, 50V range): ±100V
- Setting and changing of input signals: For each channel, any combination of thermocouples, resistance bulbs and DC voltage (50mV, 500mV, 5V, 50V ranges) can be made or altered by changing the setting pins inside the instrument.
- Record range specification: Can be made any range within the input range from the keyboard.
- Burn-out function: If a thermocouple or resistance bulb input lead breaks, the record will go to full scale.
- Reference ranges

Type		Input range		Input range	
Thermocouple	B	400	to 1760°C	752	to 3200 °F
	R	0	to 1760°C	32	to 3200°F
	S	0	to 1760°C	32	to 3200°F
	K	-200	to 1370°C	-328	to 2498°F
	E	-200	to 800°C	-328	to 1472°F
	J	-200	to 1100°C	-328	to 2012°F
	T	-200	to 400°C	-328	to 752°F
	N	0	to 1300°C	32	to 2372°F
	W	0	to 1760°C	32	to 3200°F
	L	-200	to 900°C	-328	to 1652°F
	U	-200	to 400°C	-328	to 752°F
PN	0	to 1300°C	32	to 2372°F	
Resistance bulb	JPt100	-200	to 600°C	-328	to 1112°F
	Pt100	-200	to 600°C	-328	to 1112°F
DC voltage		-50	to +50mV	Scaling in the range -32767 to 32767 is possible. (Decimal point may located where required.)	
		-500	to +500mV		
		-5	to +500mV		
		-50	to +50V		

Note:

N: NICOSIL-NISIL (IEC584)

W: +Foot 5% Re, +Foot 26% Re. W (Hoskins Mgf. Co., U.S.A.)

L: +Foot Fe, -Foot Cu, Ni alloy (DIN43710)

U: +Foot Cu, -Foot Cu, Ni alloy (DIN43710)

PN: Platinel

JPt100: JIS C 1604, 1981

Pt100: JDIN IEC 751

- Accuracy, resolution: Performance at standard conditions (23±2°C, 55±10% RH, power supply voltage and frequency fluctuation within ±1%, warm-up time 1 hour or more, vertical mounting, environment with no adverse effects of external noise, etc.)

Type of input		Indication (digital display)		Record	
		Accuracy	Resolution	Accuracy	Resolution
Thermocouple	B	±(0.15% +1 digit) (Does not include reference junction compensation error.)	0.1°C	Indication precision ±(0.25% record span)	0.1mm
	R		0.1°C		
	S		0.1°C		
	K		0.1°C		
	E		0.1°C		
	J		0.1°C		
	T		0.1°C		
	N		0.1°C		
	W		0.1°C		
	L		0.1°C		
U	0.1°C				
PN	0.1°C				
Resistance bulb	JPt100 Pt100	±(0.15% +1 digit)	0.1°C		
DC voltage	-50 to +50mV	±(0.15% +1 digit)	10µV		
	-500 to +500mV		100µV		
	-5 to +5V		1mV		
	-50 to +50V		10mV		

Note 1: The rating of indication accuracy is shown in % within the input span.

Note 2: Indication accuracy at 400 to 600°C of B-thermocouple is ± (0.25%+1 digit).

Note 3: Indication accuracy at -200 to 100°C for all thermocouples is ±(0.3%+1 digit).

Recording section

- Recording system: Ink jet system, 6 colours
- Effective recording width: 180mm
- Recording colours: 1st, 7th, 13th, 19th (orange), 2nd, 8th, 14th, 20th (green), 3rd, 9th, 15th, 21th (purple), 4th, 10th, 16th, 22th (red), 5th, 11th, 17th, 23th (black), 6th, 12th, 18th, 24th (blue)
- Chart paper: folding, total length 20m
- Chart speed: 5 to 1500mm/h
Settable in 1mm/h steps.
- Speed setting method: Set from keyboard.
- Sample time: 30 seconds/for all channels
- Measurement period: 24 points 320ms
- Ink life (depends on conditions): approximately 3 months for 24 points dot records at a recording paper feed speed of 25mm/h

Display section

- Display system: Fluorescent display (blue-green), 20 characters x 2 lines
- Display characters: 5x7 dots, character height 5.0mm, width 3.3mm
- Display contents: (1) Measured values: Temperature ... to 1st decimal place
Voltage 6 places (including symbols decimal point)
- (2) Channel Nos.: 2 characters (1 to 12)
- (3) Engineering units: Maximum 7 places (°C, °F, %, kg/cm², mmH₂O, ppm, m³/h, etc.)
- (4) Time: Year, month, day, hours, minutes
- (5) Status display: Under recording, under digital data printing, under list printing, chart end, battery alarm, alarm, ink run-out alarm, burn-out, carriage failure
- (6) Commands for setting parameters: Displayed as alphanumeric characters

Printing section

- Printing system: ink jet system, 6 colours
- Periodic printing: instantaneous values, units, date, time, time lines, chart speed
- Scale print: Scale values, scale lines, channel No., TAG No., unit
- Message printing: Any message with 10 kinds of 16 characters
- List printing: (1) Instantaneous value lists (date, time, channel Nos., instantaneous values, units)
(2) Set value lists (date, time channel Nos., record range, scaling, units, alarm set values, chart speed, Tag Nos.)
(3) Test pattern (all characters and colour patterns)
- Alarm print-outs: Channel No., type of alarm (H, L, RH, RL), output relay No., time of detection/cancellation
- Burn-out print-out: Channel where burn-out occurred and time
- Others: Ink low warning print-out, auto-range change mark, recording start mark, recording paper feed speed change

Performance, characteristics

- Input resistance: 10MΩ or more (50mV range, thermocouples), approximately 100kΩ (500mV range), approximately 1MΩ (5V, 50V range)
- Chart speed accuracy: ±0.1% (For continuous feed of 1m or more. Does not include paper elongation/shrinkage.)
- Clock precision: ±50ppm or less (monthly variation about 2 minutes)
- Insulation resistance: 100MΩ (across each terminal and ground at 500V DC)
- Withstand voltage: Input terminal — input terminal 500V AC 1 minute
Power supply terminal — ground 2000V AC 1 minute
Input terminal — ground 500V AC 1 minute
Power terminal — input terminal 500V AC, 1 minute
Between alarm terminals 750V AC, 1 minute
(Leakage current 5mA or less)
- Reference junction compensation precision: K, E, J, T, N, L, U, PN ±0.5°C
R. S. B. W ±1°C

Construction

- Mounting method: Mounted in panel (vertical panel)
Tilt angle $\alpha = 90$ to 60°

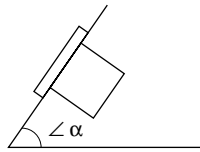

- Material: Case: steel plate
Front flap frame: glass-containing polycarbonate
- Mass: Approximately 9.6kg (without options)
Approximately 10.5kg (with all options)
- External dimensions: 288 x 288 x 295mm
- Painted color: Case black: front flap frame black
- External terminals: Screw terminals (M4 thread)

Power supply section

- Rated power voltage: 100 to 240VAC (Free power supply)
- Range of operating power voltage: 85 to 300VAC
- Supply frequency: 50/60Hz both employable
- Power consumption: 100V AC without options approximately 0VA
100V AC with all options approximately 0VA

Conditions for normal operation (for continuous operation of devices)

- Ambient temperature: 0 to 50°C
- Ambient humidity: 20 to 80% RH, but temperature \times humidity $<$ 3200
- Vibration: 10 to 60Hz, 0.2m/s^2 {0.02 G} or less
- Mounting attitude: Forward tilt 0° , rearward tilt within 30° , left/right 0°
- Signal source resistance: Thermocouple input Less than $1\text{k}\Omega$
Voltage input Less than 0.1% of input resistance
Resistance bulb input Less than 10Ω /wire (Resistance of each wire of 3-wire system should be balanced.)
- Warm-up time: 1 hour or more
- Impact: None

Effects of operating conditions:

- With 85 to 300V AC fluctuation (frequency 50 or 60Hz), 100V AC base
Indication variation \pm (0.1% of reference range + 1 digit)
Recording variation \pm 0.2% of record span
- With 47 to 63Hz fluctuation (power supply voltage: 100V AC), 50Hz base
Indication variation \pm (0.1% of reference range + 1 digit)
Recording variation \pm 0.2% of record span

- Effect of input source resistance and wiring resistance:
 - Thermocouples: 10 μ V per 100 Ω
 - Variation with resistance value equivalent to 0.1% of the input value in the case of voltage
 - Indication variation $\pm(0.1\%$ of reference range + 1 digit)
 - Recording variation $\pm 0.2\%$ of record span
 - Variation with fluctuation of 10 Ω per line in the case of resistance bulbs
 - Indication variation $\pm(0.1\%$ of reference range + 1 digit)
 - Recording variation $\pm 0.2\%$ of record span (if all 3 lines have the same resistance)
- Effect of ambient temperature:
 - Indication variation: $\pm(0.3\%$ of reference range + 1 digit)/10 $^{\circ}$ C
 - Recording variation: $\pm 0.5\%$ of record span/10 $^{\circ}$ C
- Effect of mounting attitude: With rearward tilt within 30 $^{\circ}$
 - Indication variation $\pm(0.1\%$ of reference range + 1 digit)
 - Recording variation $\pm 0.2\%$ of record span
- Effect of vibration: On 2 hours imposition of frequency 10 to 60Hz, acceleration 0.2m/s 2 {0.02 G}
 - linear vibration in each of 3 axes
 - Indication variation: $\pm(0.1\%$ of reference range + 1 digit)
 - Recording variation: $\pm 0.2\%$ of record span
- Effect of external noise: Normal mode noise: (50, 60Hz ± 0.1 Hz) 30dB or more
 Common mode noise: (50, 60Hz ± 0.1 Hz) 120dB or more
- Recording paper: On 20 $^{\circ}$ C, 65% RH base
 - Elongation at 85% RH 0.4% or less Shrinkage at 35% RH 0.5% or less

Alarms

- Setting method: Set from keyboard.
- Number set: Optional setting of Max. 4 points, 4 kinds (H, L, RH, RL) for each channel.
- Display: On detection, display section indication of alarm types, and output relay Nos. for each channel.
- Print-out: Print-out of Channel Nos., alarm types, output relay Nos. and detection/cancellation times on recording paper
- Output: As in supplementary specification
- Hysteresis amplitude: About 0.5% of record span

Transport, storage conditions

(For transport and storage, first remove the recording head from the main unit, always remembering to close the cap.)

- Temperature: -10 to +60 $^{\circ}$ C
- Humidity: 5 to 90% RH (but to be no dew condensation)
- Vibration: 10 to 60Hz, 2.45m/s 2 {0.25G}
- Impact: 294m/s 2 {30G} or less

Reference standards

- Safety Standards: IEC1010-1 (1990)
 - reinforce insulation
 - overvoltage category II except alarm output terminals (overvoltage category I)
 - pollution degree 2

- EMC Standards: EN50081-1 (1992), EN50082-1 (1992)
- Dust/drip-proofing: IP50

Supplementary specification

1. Recording paper illumination: Cold cathode fluorescent lamp
 2. Alarm output external control: Special-purpose unit needed. Unit can be mounted in rear of instrument as extra equipment at a later date.
 - (1) Alarm output (DO): 6 or 12 point of relay contact output (1a), can be for individual channels or perform OR operation.
Relay contact capacity: 240V AC, 3A (resistive load),
30V DC, 3A (resistive load)
 - (2) External control (DI): The following functions can be performed in response to external contact signals:
 - Recording operation start/stop (DI 1):
Contact signals can start/stop recording operations. Recording starts when contact is closed and stops when contact is open.
Message print is started when DI1 is specified. It is also started during recording when the contact is closed.
 - 2-stage change of chart speed (DI 2):
Contact signals can effect a change from normal recording paper feed speed to remote mode chart speed. Closing the contact gives remote mode chart speed.
Opening the contact gives normal chart speed.
But, message printed when DI2 has been specified. During recording, message print is started when the contact is closed.
 - Instantaneous value print-out (DI 3)
Instantaneous value lists (dates, times, channel Nos., measured values, units) are printed out in response to contact signals. Print-out starts when the contact is closed and stops when the contact is opened.
But, latch is OFF when alarm latch function is ON. It is also OFF when the contact is closed.
- Note: As the external control unit is not insulated, use it with insertion of an external relay.
Contact capacity: 12V DC, 0.05A 1a contact

Option accessories (available separately)

Article name	Type	Specification
Shunt resistance	PHZT8101	10Ω±0.1%, for 4 to 20mA DC, 10 to 50mA DC input

Standard functions

Function		Content
Arbitrary range setting		Any record range can be set for each individual channel
Arbitrary specification of input signals		Any type of input can be specified for each individual channel
Skip function		Function for skipping the records, indications and alarms at any measurement point
List print-out function	Instantaneous values list	Dates, times and the measured values and units for each channel are printed out.
	Set values list	Dates, times, recording ranges, scaling, units, input types, alarm set values, recording paper feed speed and Tag Nos. are printed out.
	Test pattern	All the types of characters and color patterns are printed out.
Periodic print-out function		Time lines, dates, times, recording paper feed speed and measured values for each channel are printed out at set intervals of time. The keyboard can be used to allow or to prohibit print-outs.
Message print function		Messages of up to 10 kinds and 16 characters which have arbitrarily specified are printed. Message print is started when the contact is closed.
Alarm print-out function		The times of detection of alarms and clearing of alarms, the channel Nos. alarm types and output relay Nos. are printed out.
Units display		°C, °F, %, mV, mA, kg/cm ² and other working units are displayed. (Units can be specified from the keyboard.)
Scaling function		In the case of DC voltage input, any scaling is possible. Any specification in the range -32767 to 32767, with the decimal point anywhere, is possible.
Difference records		The differences between any specified channels are recorded. (Channels are specified from the keyboard.)
Auto-range change function		Function whereby if input goes above or below the current range the range is automatically changed and the change is recorded (specified for the keyboard.) However, this function cannot be used if zone recording or zoom recording is used.
Zone recording function		Function for effecting recording with the recording area divided into a maximum of 4 zones. However, this function cannot be used if auto-range recording or zoom recording is used.
Zoom function		Function for effecting recording with one part of the recording area for each channel enlarged and another reduced. However, this function cannot be used if auto-range recording or zone recording is used.
Square root extraction function		DC voltage input $\sqrt{\quad}$ calculations can be performed.
Logarithmic calculation function		10 ⁿ input is permitted with DC voltage input. Display, 1.0E-9 to 1.0E+9.
PV shift function		To set zero shift and gain shift of measured value.
Recording color change function		To change the recording and print color of each channel.

Function	Content
Daily report function	Max. 1-day lots (lots of max. 24 data items) of the instantaneous values at each full hour for each channel each day are stored and printed out. At the same time, maximum values, minimum values and average values are printed out too. The operation is turned on/off for individual channels and the operation start time is specified from the keyboard.
Data sum function	Max. 1-day lots (lots of max. 24 data items) of the integration values for 1-hour periods in each channel each day are stored and printed out. At the same time, maximum values, minimum values and average values are printed out too. The operation is turned on/off for individual channels and the operation start time is specified from the keyboard.
Memory backup function	Set data and clock functions are protected by a lithium battery incorporated in the recorder. (Battery life is about 10 years at normal temperature.)
Input filter	Filter function for delaying the response of each channel to counter sharp changes in input. (Primary delay filters) Time constant setting range: 0 to 900 seconds (set from the keyboard)
Burn-out function	If thermocouple or resistance bulb wire breakage occurs, there is a swing to the maximum value of recording range and at the same time a display is given and a printed record is made.
Alarm latch function	Used to hold alarm display and alarm output even after alarm is recovered. ON/OFF operation is made form the keyboard. Alarm in hold mode is released by external control (DI)
Set value copying function	Used to copy the value, which has been set in any channel, to another channel.

Fuji Electric Systems Co., Ltd.

Head Office

Gate City Ohsaki, East Tower, 11-2, Osaki 1-chome,
Shinagawa-ku, Tokyo 141-0032, Japan
<http://www.fesys.co.jp/eng>

Instrumentation Div.

International Sales Dept.

No.1, Fuji-machi, Hino-city, Tokyo 191-8502, Japan
Phone: 81-42-585-6201, 6202 Fax: 81-42-585-6187
<http://www.fic-net.jp/eng>
