



Instruction Manual

**PAPERLESS RECORDER
COMMUNICATION
FUNCTIONS
(RS-485 MODBUS/Ethernet)**

TYPE: PHR

Note: MODBUS® is the trade mark or registered trade mark of AEG Schneider Automation International.

Note: GW-BASIC, Windows 98, MS-DOS and Internet Explorer are the trade mark or registered trademarks of Microsoft Corporation.

— NOTICE —

1. Exemption items from responsibility

The contents of this document may be changed in the future without prior notice.

We paid the utmost care for the accuracy of the contents. However, we are not liable for direct and indirect damages resulting from incorrect descriptions, omission of information, and use of information in this document.

CONTENTS

1.	COMMUNICATION FUNCTIONS	1
1.1	General	1
1.2	Overview of MODBUS slave communication function (RS-485 interface)	1
1.3	Overview of Ethernet communication functions	2
2.	SPECIFICATIONS	3
2.1	Communication Specifications	3
3.	CONNECTION	4
3.1	Communication Terminal Allocation	4
3.2	Wiring	5
4.	SETTING OF COMMUNICATION CONDITION	6
4.1	Set Items	6
4.2	Setting Operation Method	7
5.	MODBUS COMMUNICATION PROTOCOL	8
5.1	General	8
5.2	Composition of Message	9
5.3	Response of Slave Station	10
5.4	Function Code	11
5.5	Calculation of Error Check Code (CRC-16)	12
5.6	Transmission Control Procedure	13
5.7	FIX Processing (Cautions in data write)	15
6.	DETAILS OF MESSAGE	16
6.1	Read-out of Word Data [Function code:03 _H]	16
6.2	Read-out of Read-out Only Word Data [Function code:04 _H]	18
6.3	Write-in of Continuous Word Data [Function code:10 _H]	20
7.	ADDRESS MAP AND DATA FORMAT	22
7.1	Data Format	22
7.2	Address Map	23
7.3	Additional Explanation of Address Map	39
8.	SAMPLE PROGRAM	48
9.	ETHERNET COMMUNICATION FUNCTIONS	53
9.1	LAN port specification	53
9.2	Connection to the terminal	53
9.3	Connection	53
9.4	Setting Ethernet communicating conditions	54
9.5	Ethernet communicating conditions setting operation	54
10.	FTP SERVER FUNCTION	55
10.1	Description of FTP server function	55
10.2	Setting FTP server function	57
10.3	FTP server function setting operation	57
10.4	FTP server operation	58
11.	Web server function	59
11.1	Description of web server function	59
11.2	Setting web server function	59

11.3	Web server function setting operation.....	59
11.4	Web server operation	60
11.5	Web monitor screen	60
12.	E-MAIL SEND FUNCTION	63
12.1	Description of E-mail send function	63
12.2	Setting E-mail function	63
12.3	E-mail function setting operation.....	64
12.4	E-mail send test operation	67
12.5	E-mail send contents	67
13.	MODBUS TCP/IP FUNCTION	68
13.1	Description of MODBUS TCP/IP function.....	68
13.2	Setting MODBUS TCP/IP function	68
13.3	MODBUS TCP/IP function setting operation.....	68
13.4	MODBUS TCP/IP communication protocol.....	69
14.	TROUBLESHOOTING.....	71

1. COMMUNICATION FUNCTIONS

1.1 General

- This equipment provides a communication function (optional) using an RS-485 interface and also a communication function (optional) using an Ethernet interface.

1.2 Overview of MODBUS slave communication function (RS-485 interface)

See Chapter 2 through Chapter 8 for the method for use of MODBUS slave communication function in detail.

- The MODBUS slave communication function permits exchange of data with host computer, programmable controller, graphic display panel, etc.
- The communication system consists of master station and slave stations. Up to 31 slave stations (PHR) can be connected per master station.

Note that, because the master station can communicate with only one slave station at a time, a party to communicate with must be specified by the “MODBUS Station No.” set at each slave station.

- In order that the master station and slave station can communicate, the format of the transmit/receive data must coincide. For the PHR, the format of the communication data is determined by the MODBUS protocol.
- Please use an RS-232C \leftrightarrow RS-485 converter in case of designating a personal computer or other devices which have an RS-232C interface as a master station.

[RS-232C \leftrightarrow RS-485 converter] (recommended article)

Type: K3SC-10 (isolated type)/ OMRON Corporation.

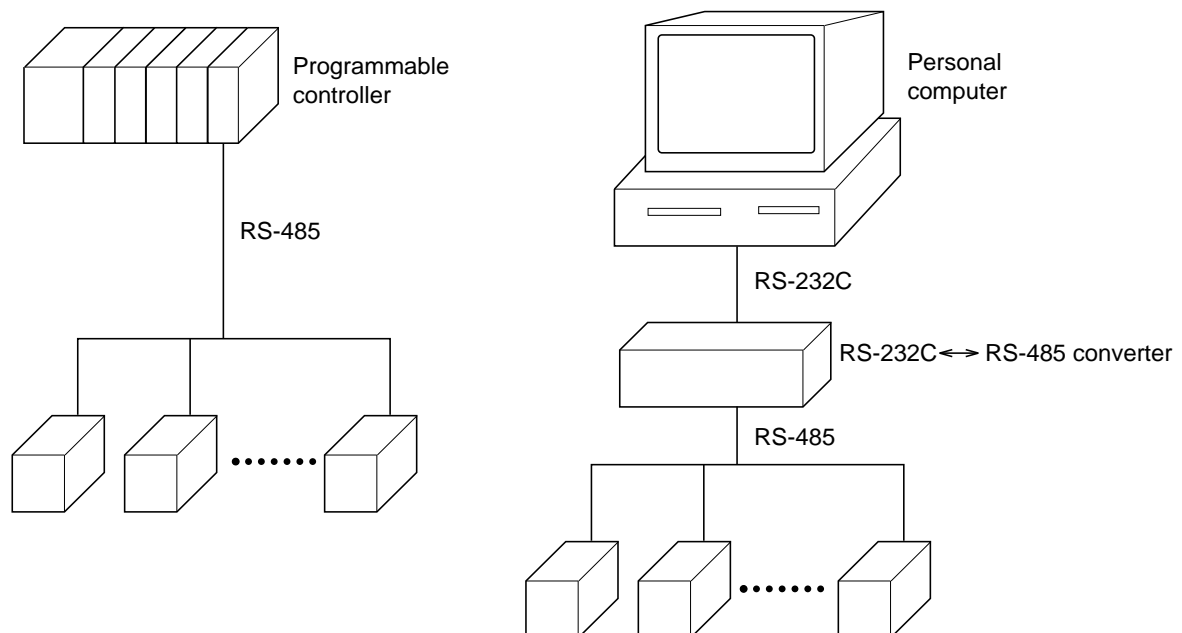

Caution:

When using the RS-232C \leftrightarrow RS-485 converter, pay attention to cable connection between the converter and master station. If the cable is not connected correctly, the master station and slave station cannot communicate. In addition, be careful about communication settings such as baud rate and parity set for the converter.

1.3 Overview of Ethernet communication functions

See Chapter 10 and Chapter 11 for the method for use of Ethernet communication functions in detail.

- The following functions are available as Ethernet communication functions.
 - (1) FTP server function
Permits take-out of files from the compact flash of the paperless recorder, using personal computer's browser (Internet Explorer Ver.6) or DOS prompt.
 - (2) Web server function
Permits check of measured values and event information recorded in the paperless recorder, using personal computer's browser (Internet Explorer Ver.6).
 - (3) E-mail send function
Permits E-mail transmission in a fixed period and also on occurrence of an alarm.
 - (4) MODBUS TCP/IP function
Permits exchange of data with host computer, programmable controller, graphic display panel, etc. by MODBUS TCP/IP communication.

Note: The other browsers, for example Netscape, Mozilla Fire-fox, are not available.

2. SPECIFICATIONS

2.1 Communication Specifications

Item	Specification	
Electrical specification	Based on EIA RS-485	
Transmission system	2-wire, semi-duplicate	
Synchronizing system	Start-stop synchronous system	
Connection format	1 : N	
Number connectable units	Up to 31 units	
Transmission distance	500m max. (total extension distance)	
Transmission speed	9600, 19200 bps	
Data format	Data length	8 bits
	Stop bit	1 bit
	Parity	none, even, odd (selectable)
Transmission code	HEX value (MODBUS RTU mode)	
Error detection	CRC-16	
Isolation	Functional isolation between transmission circuit and ground (withstand voltage : 500V AC)	

3. CONNECTION

⚠ WARNING
 For avoiding electric shock and malfunctions, do not turn on the power supply until all wiring have been completed.

3.1 Communication Terminal Allocation

Signal name
TRX2 ⊖
TRX1 ⊕

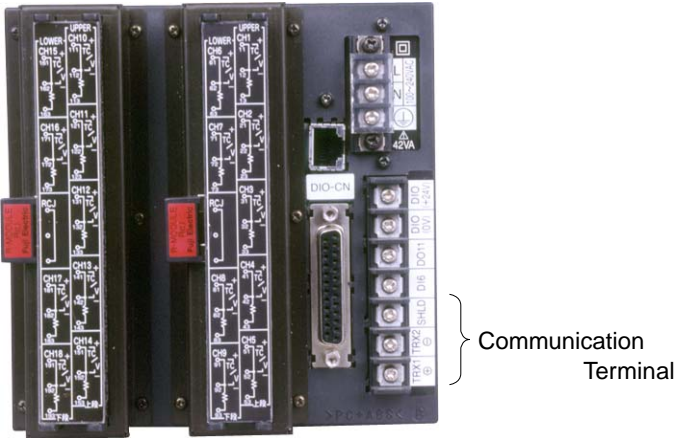

Communication Terminal

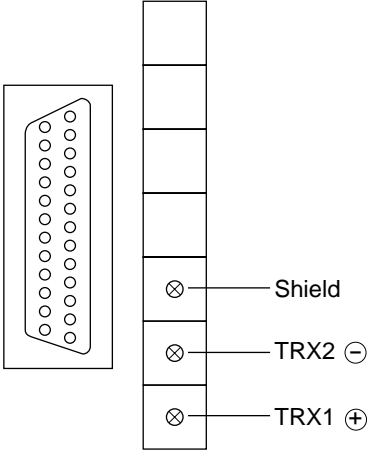

3.2 Wiring

- Use twisted pair cables with shield.
Recommended cable: UL2464, UL2448, etc.
- The total extension length of the cable is up to 500 m. A master station and up to 31 units of the PHR can be connected per line.
- Both ends of the cable should be terminate with terminating resistors 100Ω ($1/2W$).
- The shield wire of the cable should be grounded at one place on the master station unit side.
- If the PHR is to be installed where the level of noise applied to the PHR may exceed 1000 V, it is recommended to install a noise filter in the master station side as below.

Recommended noise filter: ZRAC2203-11/TDK

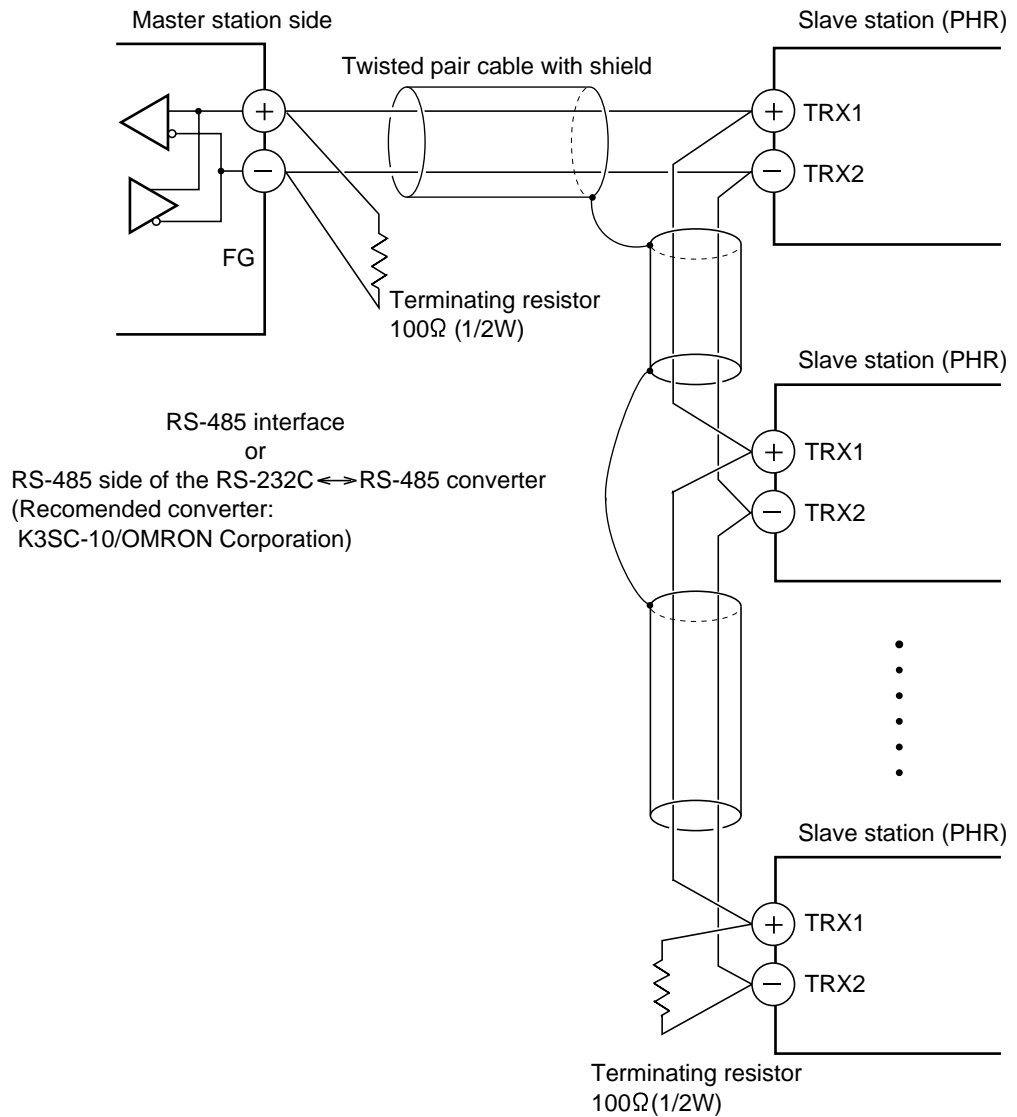
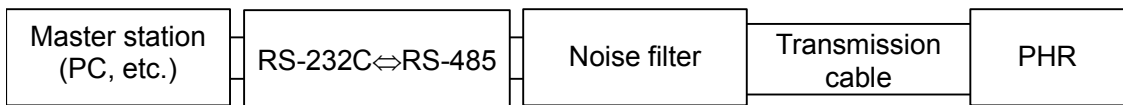

4. SETTING OF COMMUNICATION CONDITION

In order that the master station and instrument (PHR) can correctly communicate, following settings are required.

- All communication condition settings of the master station are the same as those of instruments (PHR).
- All instruments (PHR) connected on a line are set to “MODBUS Station No.” which are different from each other. (Any “MODBUS Station No.” is not shared by more than one instrument.)

4.1 Set Items

The parameters to be set are shown in the following table. Set them by operating the front panel keys.

Item	Value at delivery	Setting range	Remarks
Station No.	1	0 to 255 (0:communication function stop)	Set a different value to each station.
Transmission speed	19200bps	9600bps, 19200bps	Set the same communication condition to the master station and all slave stations.
Parity setting	Odd	None:None parity Odd:Odd parity Even:Even parity	
Data length	8bit	Fixed (can not be changed)	
Stop bit	1bit	Fixed (can not be changed)	

4.2 Setting Operation Method

The following example shows how to set the communication conditions.

Example: Selecting an even parity and “STno=10 and 9600bps” on a station.

Keys used	Display	Meanings
	Trend display	Operation state (Trend display)
SEL	Parameter Setting	Press the [SEL] key to display the Parameter Setting screen.
∨	Main unit	Press the [∨] key two times to select Main unit. (When the key pressed more than two times, use the [∧] key to back.)
ENT	Register data	Press the [ENT] key to select Register data
∨	Communication	Press the [∨] key seven times to select Communication.
ENT	Communication setting	Press the [ENT] key to display the Communication setting screen.
ENT	Numeric value entering screen	Press the [ENT] key to display the Numeric value entering screen.
∨	10	Use [<], [>], [∧], or [∨] key to change the numeric value to 10.
ENT	MODBUS Station No.	Press the [ENT] key to confirm the MODBUS Station No.
∨	MODBUS baud rate	Press the [∨] key to select the MODBUS baud rate.
<	9600	Press the [<] key to select “9600”.
∨	MODBUS parity	Press the [∨] key to select the MODBUS parity.
<	Even	Press the [<] key to select “Even”.
∨	Front communication	Press the [∨] key to select the Front communication.
DISP	Select screen for saving the settings	Press the [DISP] key to display a screen asking you want to save the setting.
ENT	Confirmation screen for saving the settings	Press the [ENT] key to save the setting. (The confirmation screen appears.)
ENT	Trend display	The Trend screen appears.
Power OFF	————	Turn off the power.
Power ON	Trend display	Turn on the power once again to complete the setting.

5. MODBUS COMMUNICATION PROTOCOL

5.1 General

The communication system by the MODBUS protocol is that the communication is always started from the master station and a slave station responds to the received message.

Transmission procedures is as shown below.

- 1) The master station sends a command message to a slave station.
- 2) The slave station checks that the station No. in the received message matches with the own station No. or not.
- 3) If matched, the slave station executes the command and sends back the response message.
- 4) If mismatched, the slave station leaves the command message and wait for the next command message.

- a) In case when the station No. in the received command message matches with the own slave station No.

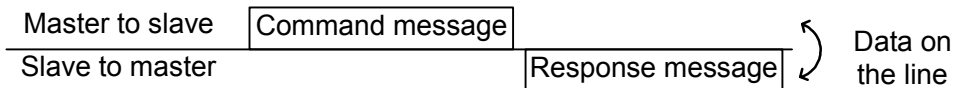

- b) In case when the station No. in the received command message mismatches with the own slave station No.

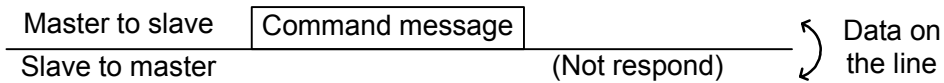

- 5) To assure safety, provide a structure where the response message is checked and retry is made three (3) times or more if no response is made or an error occurs.

The master station can individually communicate with any one of slave stations connected on the same line upon setting the station No. in the command message.

5.2 Composition of Message

Command message and response message consist of 4 fields ; Station No., Function code, Data and Error check code. And these are send in this order.

Station No. (1 byte)
Function code (1 byte)
Data (2 to 133 bytes)
Error check code (CRC-16) (2 bytes)

Fig. 5-1 Composition of message

In the following, each field is explained.

(1) Station No

Station No. is the number specifying a slave station. The command message is received and operated only by the slave station whose station No. matches with the No. set in the parameter “MODBUS Station No.”

For details of setting the parameter “MODBUS Station No.”, refer to chapter 4.

(2) Function code

This is a code to designate the function executed at a slave station.

For details, refer to section 5.4.

(3) Data

Data are the data required for executing function codes. The composition of data varies with function codes. For details, refer to chapter 6.

A register number is assigned to each data in the recorder. For reading/writing the data by communication, designate the register number.

Note that the register number transmitted on message is expressed as its relative address.

The relative address is calculated by the following expression.

$$\boxed{\text{Relative address}} = \left(\text{The lower 4 digits of the } \boxed{\text{register number}} \right) - 1$$

For example, when the register number designated by a function code is 40003,

$$\begin{aligned} \text{Relative address} &= (\text{lower 4 digits of } 40003) - 1 \\ &= 0002 \end{aligned}$$

is used on the message.

(4) Error check code

This is the code to detect message errors (change in bit) in the signal transmission.

On the MODBUS protocol (RTU mode), CRC-16 (Cyclic Redundancy Check) is applied.

For CRC calculation method, refer to section 5.5.

5.3 Response of Slave Station

(1) Response for normal command

To a relevant message, the slave station creates and sends back a response message which corresponds to the command message. The composition of message in this case is the same as in section 5.2.

Contents of the data field depend on the function code. For details, refer to Chapter 6.

(2) Response for abnormal command

If contents of a command message have an abnormality (for example, non-actual function code is designated) other than transmission error, the slave station does not execute that command but creates and sends back a response message at error detection.

The composition of response message at error detection is as shown in Fig. 5-2. The value used for function code field is function code of command message plus 80_H.

Table 5-1 gives error codes.

Station No.
Function code + 80 _H
Error code
Error check (CRC-16)

Fig. 5-2 Response message at error detection

Table 5-1 Error Code

Error code	Contents	Description
01H	Illegal function code	Non-actual function code is designated. Check for the function code.
02H	Illegal data address	A relative address of a register number to which the designated function code can not be used.
03H	Illegal data number	Because the designation of number is too much, the area where register numbers do not exist is designated.

(3) No response

Under any of the following items, the slave station takes no action of the command message and sends back no response.

- A station number transmitted in the command message differs from the station number specified to the slave station.
- A error check code is not matched, or a transmission error (parity error, etc.) is detected.
- The time interval between the composition data of the message becomes longer than the time corresponding to 24 bits. (Refer to section 5.6 Transmission Control Procedure)
- Station No. of a slave station is set to 0.

5.4 Function Code

According to MODBUS protocol, register numbers are assigned by function codes.

Each function code acts on specific register number.

This correspondence is shown in Table 5-2, and the message length by function is shown in Table 5-3.

Table 5-2 Correspondence between function codes and objective address

Function code			Resister No.		
No.	Function	Object	No.	Contents	
03 _H	Read-out (continuously)	Holding register	4xxxx	Read-out/write-in	word data
04 _H	Read-out (continuously)	Input register	3xxxx	Read-out	word data
10 _H	Write-in (continuously)	Holding register	4xxxx	Read-out/write-in	word data

Table 5-3 Function code and message length

[Unit:byte]

Function code	Contents	Number of designatable data	Command message		Response message	
			Minimum	Maximum	Minimum	Maximum
03 _H	Read-out of word data	64 words	8	8	7	133
04 _H	Read-out of word data (read-out only)	64 words	8	8	7	133
10 _H	Write-in of continuous word data	64 words	11	137	8	8

5.5 Calculation of Error Check Code (CRC-16)

CRC-16 is the 2-byte (16-bits) error check code. From the top of the message (station No.) to the end of the data field are calculated.

The slave station calculates the CRC of the received message, and does not respond if the calculated CRC is different from the contents of the received CRC code.

Fig. 5-3 shows the flow of the CRC-16 calculation system.

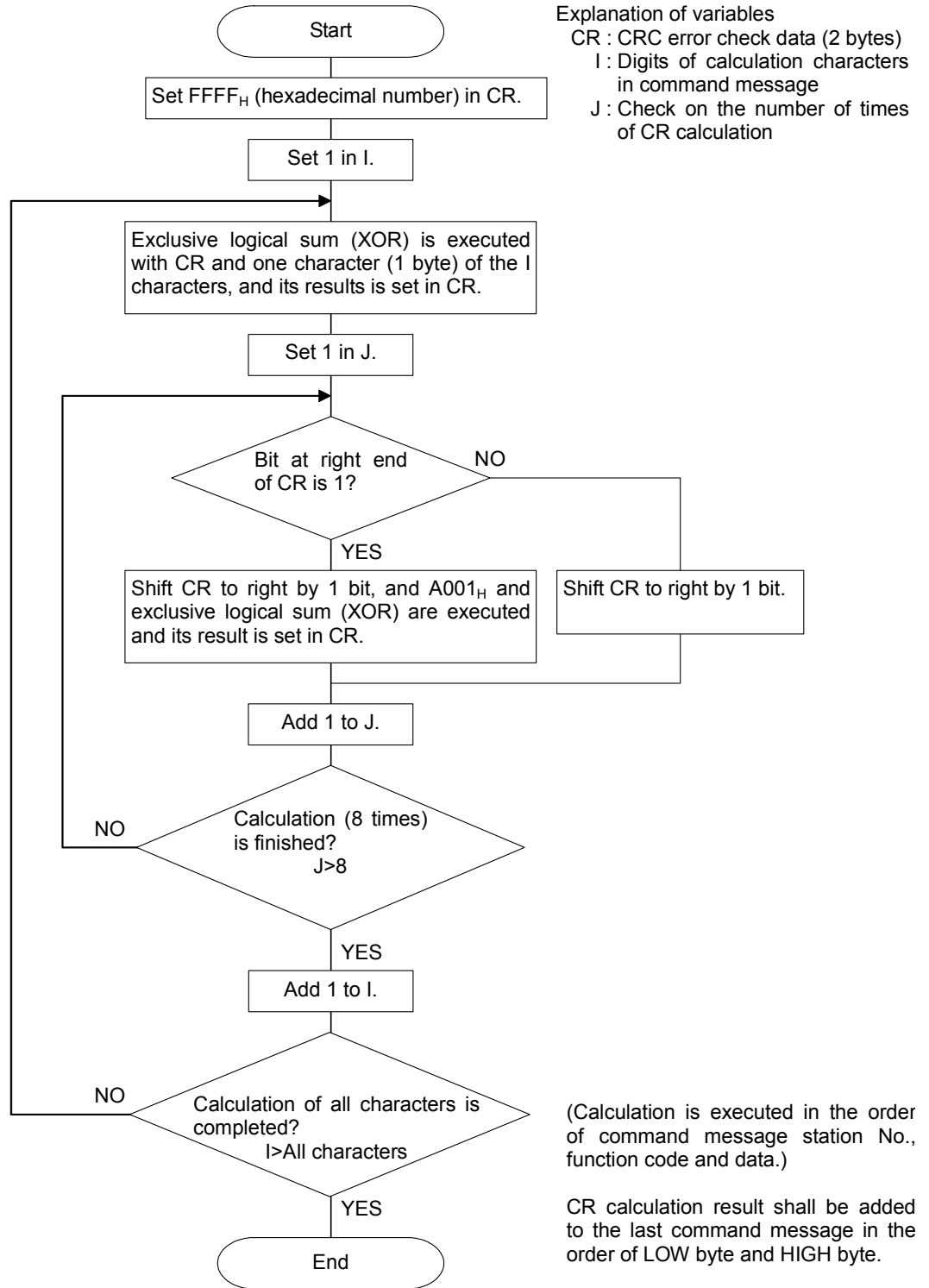

Fig. 5-3 Flow of CRC-16 calculation

5.6 Transmission Control Procedure

(1) Transmission procedure of master station

The master station must proceed to a communication upon conforming to the following items.

- (1-1) Before sending a command message, provide 48 bits time or more vacant status.
- (1-2) For sending, the interval between bytes of a command message is below 24 bits time.
- (1-3) Within 24 bits time after sending a command message, the receiving status is posted.
- (1-4) Provide 48 bits time or more vacant status between the end of response message reception and beginning of next command message sending [same as in (1-1)].
- (1-5) For ensuring the safety, make a confirmation of the response message and make an arrangement so as to provide 3 or more retries in case of no response, error occurrence, etc.

Note) The above definition is for most unfavorable value. For ensuring the safety, it's recommended the program of the master to work with safety factors of 2 to 3. Concretely, it is advised to arrange the program for 9600 bps with 10 ms or more for vacant status (1-1), and within 1 ms for byte interval (1-2) and changeover from sending to receiving (1-3).

(2) Description

1) Detection of the message frame

Since the communication system uses the 2-wire RS-485 interface, there may be 2 statuses on a line below.

- (a) Vacant status (no data on line)
- (b) Communication status (data is existing)

Instruments connected on the line are initially at a receiving status and monitoring the line. When 24 bits time or more vacant status has appeared on the line, the end of preceding frame is assumed and, within following 24 bits time, a receiving status is posted. When data appears on the line, instruments receive it while 24 bits time or more vacant status is detected again, and the end of that frame is assumed. I.e., data which appeared on the line from the first 24 bits time or more vacant status to the next 24 bits time or more vacant status is fetched as one frame.

Therefore, one frame (command message) must be sent upon confirming the following.

- (1-1) 48 bits time or more vacant status precedes the command message sending.
- (1-2) Interval between bytes of 1 command message is smaller than 24 bits time.

2) Response of this instrument (PHR)

After a frame detection (24 bits time or more vacant status), this instrument carries out processing with that frame as a command message. If the command message is destined to the own station, a response message is returned. Its processing time is 300 to 500 ms (depends on contents of command message).

After sending a command message, therefore, the master station must observe the following

- (1-3) Receiving status is posted within 24 bits time after sending a command message.

Space time of longer than 5ms is needed.
(longer than 10ms is recommended.)

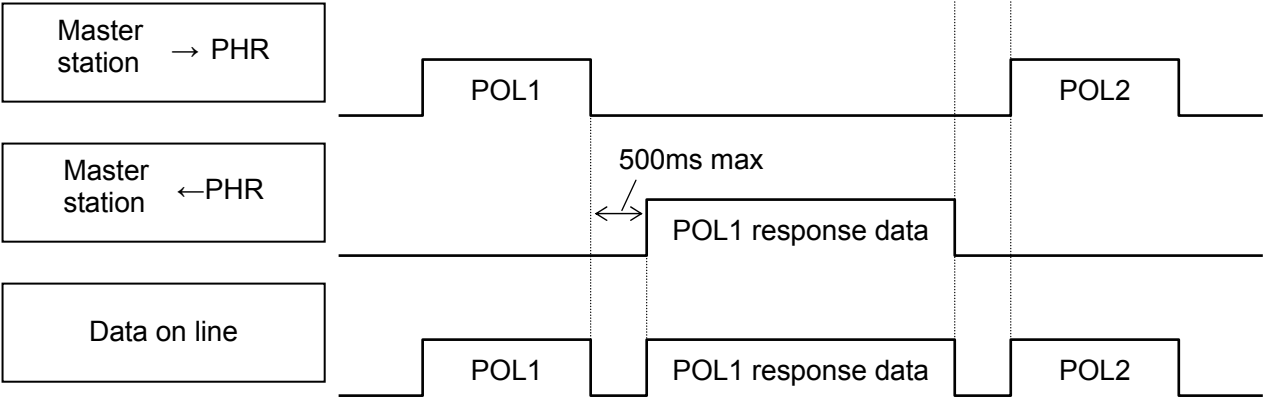

5.7 FIX Processing (Cautions in data write)

The instrument is provided inside with a non-volatile memory (F-ROM) for holding the setting parameters. Data written in the non-volatile memory is not lost even if turning off the power.

To hold parameters that were written in the internal memory via communication after turning off the power, the FIX process is effective. It allows parameters to be written in nonvolatile memory.

Fig. 5-4 shows the FIX procedure.

Cautions:

- Write in the non-volatile memory takes approximately 2 seconds.
- While writing, do not turn off the power of the PHR. Otherwise, the data in the non-volatile memory will be destroyed, whereby the PHR could not be used any longer.
- Don't change parameters on the front panel when performing the FIX procedure, or memory error may result.
- The non-volatile memory (F-ROM) is a device where the number of write-in times is limited. The guaranteed number of write-in times of the non-volatile memory used on the instrument is 100,000 minimum. Therefore, limit the times of change of parameter setting to absolute minimum. Refrain from carrying out the FIX processing periodically for example or while such is not absolutely required.

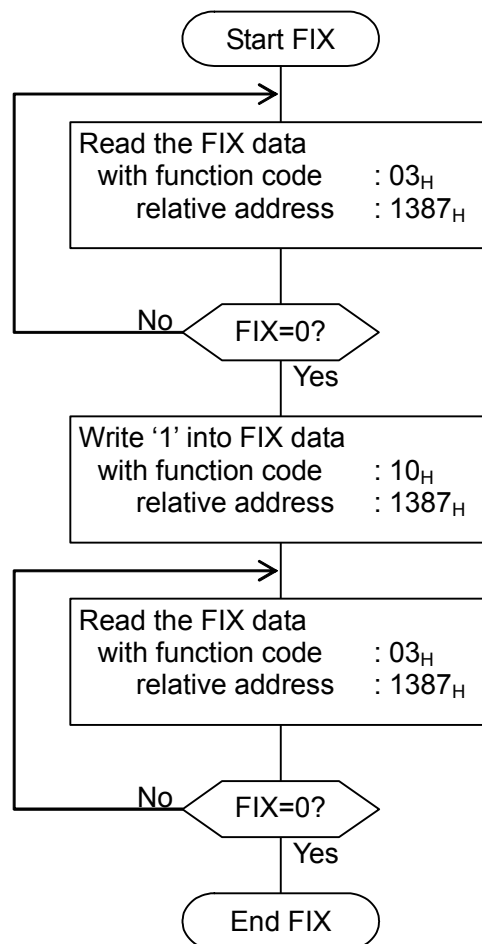

Fig. 5-4 FIX procedure

6. DETAILS OF MESSAGE

6.1 Read-out of Word Data [Function code:03_H]

Function code	Max. word number read-out in one message	Relative data address	Register No.	Kind of data
03 _H	64 words	0000 _H —1386 _H	40001—44999	Storage enable data
		1387 _H —176F _H	45000—46000	Storage disable data

(1) Message composition

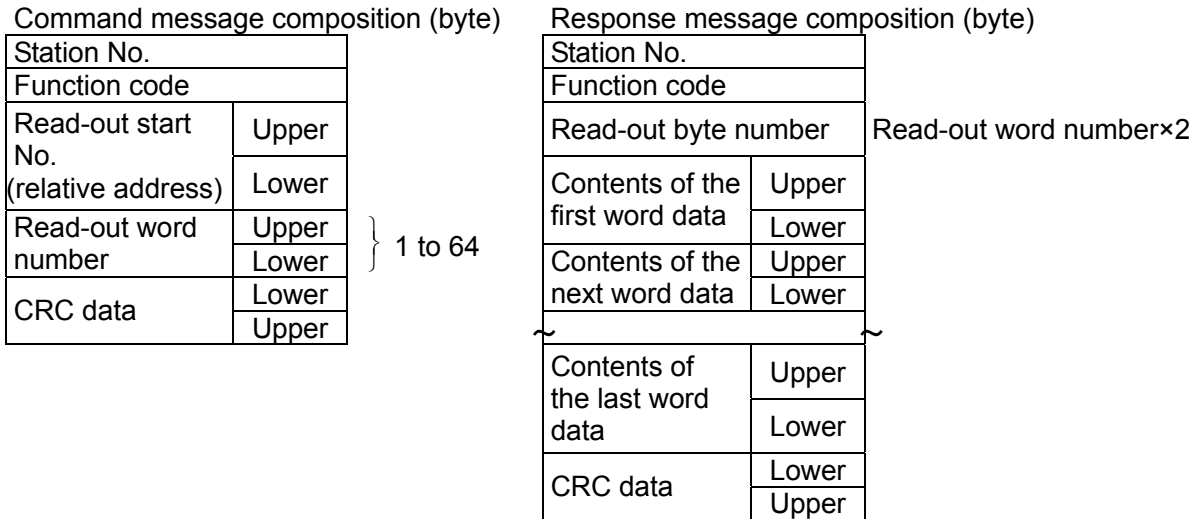

* Arrangement of read-out word data

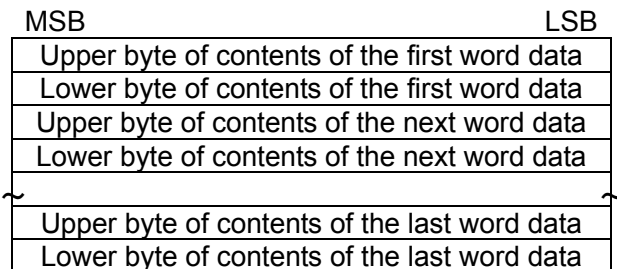

(2) Function explanations

Word data of continuous word numbers from the read-out start No. can be read. Read-out word data are transmitted from the slave station in the order of upper and lower bytes.

(3) Message transmission (example)

Reading range start and range end in Channel 1 from No. 2 station is shown below.

Relative address of range start in Channel 1: 001B_H(Register No.40028), Data number: 02_H

Station No.		02 _H
Function code		03 _H
Read-out start No. (relative address)	Upper	00 _H
	Lower	1B _H
Read-out word number	Upper	00 _H
	Lower	02 _H
CRC data	Lower	B4 _H
	Upper	3F _H

Station No.		02 _H
Function code		03 _H
Read-out byte number		04 _H
Contents of the first word data	Upper	00 _H
	Lower	00 _H
Contents of the next word data	Upper	0F _H
	Lower	A0 _H
CRC data	Lower	CC _H
	Upper	BB _H

* Meaning of data to be read

Channel 1 Range start 00 00_H = 0

(contents of the first word data)

Channel 1 Range end 0F A0_H = 4000

(contents of the next word data)

Where the unit is °C with decimal point position set at 1,

Channel 1 Range start = 0.0°C

Channel 1 Range end = 400.0°C

➤Point➤ For "Point" decimal point, refer to Section 7.1

6.2 Read-out of Read-out Only Word Data [Function code:04_H]

Function code	Max. word number read-out in one message	Relative data address	Register No.
04 _H	64 words	0000 _H —07CF _H	30001—32000

(1) Message composition

Command message composition (byte)		Response message composition (byte)	
Station No.		Station No.	
Function code		Function code	
Read-out start No. (relative address)	Upper	Read-out byte number	Read-out word number×2
	Lower		
Read-out word number	Upper	Contents of the first word data	Upper
	Lower		
CRC data	Lower	Contents of the next word data	Upper
	Upper		
		Contents of the last word data	Upper
		CRC data	Lower

* Arrangement of read-out word data

MSB	LSB
Upper byte of contents of the first word data	
Lower byte of contents of the first word data	
Upper byte of contents of the next word data	
Lower byte of contents of the next word data	
~	
Upper byte of contents of the last word data	
Lower byte of contents of the last word data	

(2) Function explanations

Word data of continuous word numbers from the read-out start No. can be read. Read-out word data are transmitted from the slave station in the order of upper and lower bytes.

(3) Message transmission (example)

Reading measured values in Channel 2 from No. 1 station is shown below.

Relative address of measured value in Channel 2: 0065_H (Register No.30102),

Data number: 01_H

Command message composition (byte)

Station No.		01 _H
Function code		04 _H
Read-out start No. (relative address)	Upper	00 _H
	Lower	65 _H
Read-out word number	Upper	00 _H
	Lower	01 _H
CRC data	Lower	21 _H
	Upper	D5 _H

Response message composition (byte)

Station No.		01 _H
Function code		04 _H
Read-out byte number		02 _H
Contents of the first word data	Upper	01 _H
	Lower	4F _H
CRC data	Lower	F9 _H
	Upper	54 _H

* Meaning of data to be read

Channel 2 Measured value 01 4F_H = 335

(contents of the first word data)

Where the unit is °C with decimal point position set at 1

Channel 2 Measured value = 33.5°C

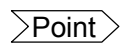

For "Point" decimal point, refer to Section 7.1.

6.3 Write-in of Continuous Word Data [Function code:10_H]

Function code	Max. word number write-in in one message	Relative data address	Register No.	Kind of data
10 _H	64 words	0000 _H —1386 _H	40001—44999	Storage enable data
		1387 _H —176F _H	45000—46000	Storage disable data

(1) Message composition

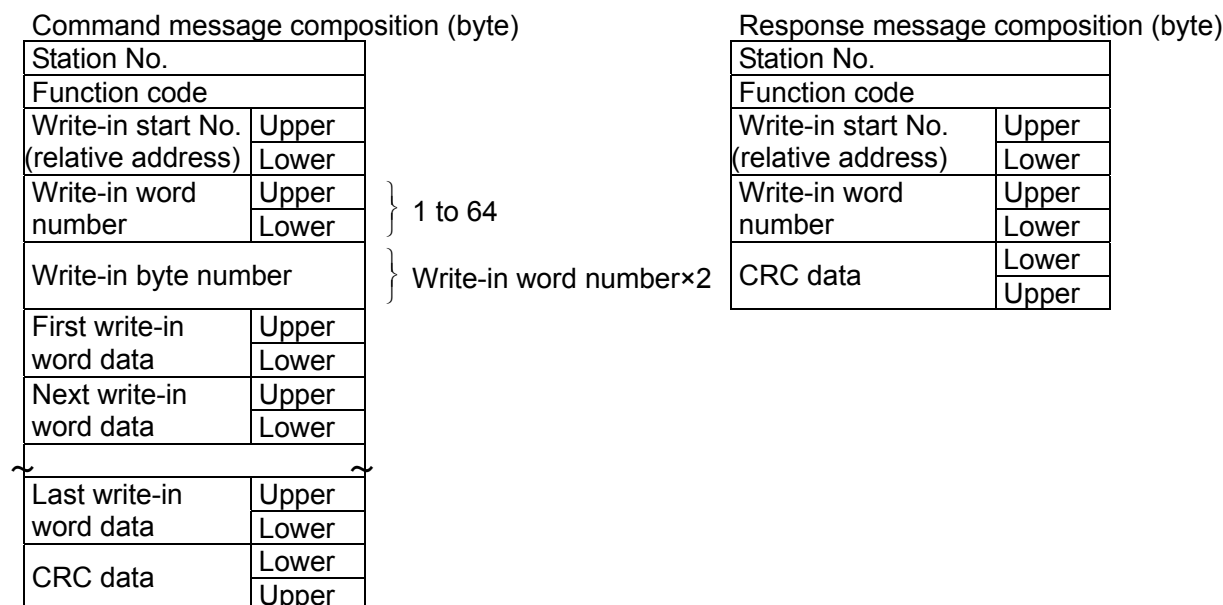

* Arrangement of write-in word data

MSB	LSB
Upper byte of contents of the first word data	
Lower byte of contents of the first word data	
Upper byte of contents of the next word data	
Lower byte of contents of the next word data	
Last word data	
Upper byte of contents of the last word data	
Lower byte of contents of the last word data	

(2) Function explanation

Word data of continuous word number is written from write-in start address. Write-in word data are transmitted from master station in the order of upper and lower bytes.

(3) Message transmission (example)

Writing Subtract channel = channel 2, PV shift = 20.0°C, and PV gain = 110.0% in

Channel 1 of No. 1 station is shown below.

Subtract channel = 0002H (= 2D : channel 2)

PV shift = 00C8H (= 200D)

Input filter = 044CH (= 1100D)

Relative address of Subtract channel in Channel 1: 0014_H (Register No.40021), Data number: 03_H

Command message composition (byte)

Station No.		01 _H
Function code		10 _H
Write-in start No. (relative address)	Upper	00 _H
	Lower	14 _H
Write-in word number	Upper	00 _H
	Lower	03 _H
Write-in byte number		06 _H
First write-in word data	Upper	00 _H
	Lower	02 _H
Next write-in word data	Upper	00 _H
	Lower	C8 _H
Last write-in word data	Upper	04 _H
	Lower	4C _H
CRC data	Lower	5D _H
	Upper	CB _H

Response message composition (byte)

Station No.		01 _H
Function code		10 _H
Write-in start No. (relative address)	Upper	00 _H
	Lower	14 _H
Write-in word number	Upper	00 _H
	Lower	03 _H
CRC data	Lower	41 _H
	Upper	CD _H



Since the transmission data can not include a decimal point, data of 110.0 is transmitted as "1100".

For transmission format of each data, refer to the address map (Chapter 7)

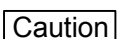

If the write-in command message is sent to any slave station during the FIX process, response is not returned from it.

7. ADDRESS MAP AND DATA FORMAT

7.1 Data Format

7.1.1 Transmission data format

The MODBUS protocol used in this instrument (PHR) is RTU (Remote Terminal Unit) mode. Transmitted data is “numeric value” and not “ASCII code”.

7.1.2 Control of decimal point

A decimal point is not included on the transmission data.

Align decimal point for data that have decimal point (decimal point is eliminated in transmission, and added in receiving).

7.1.3 Data with input error

When input error (Over, Under, Burnout or Error) occurs in display data, read data from measured values are as follows.

Display data	Read data
Over	32767
Under	-32767
Bunout	-32768
Error	-32768

Detection of input error during communication can be performed at address 30131 = Channel status.

7.1.4 Range of write-in data

When data is written in each parameter, the write-in data should be kept within the setting range. PHR accepts the write-in data beyond the range. However, be careful since the PHR performance will not be guaranteed.

7.2 Address Map

For detailed contents about individual parameter function or setting range, refer to the operation manual.

Data type Long: long data The data of this address is manipulated in unit of word. 1 data/2 address

Word: word data The data of this address is manipulated in unit of word. 1 data/1 address

Byte: byte data The data of this address is manipulated in unit of byte. A maximum of 2 data/1 address

Bit: Bit data The data of this address is manipulated in unit of bit. A maximum of 16 data/1 address

7.2.1 Word data [read-out / write-in] : Function code [03H, 10H]

Register No.	Data type	Memory contents	Read-out data / Write-in data setting range	Remarks
4 xxxx				
40001	Byte	Tag 1	1st, 2nd characters	Set Tag 1 (8 characters) by the ASCII code.
40002	Byte		3rd, 4th characters	
40003	Byte		5th, 6th characters	
40004	Byte		7th, 8th characters	
40005	Byte	Tag 2	1st, 2nd characters	Set Tag 2 (8 characters) by the ASCII code.
40006	Byte		3rd, 4th characters	
40007	Byte		5th, 6th characters	
40008	Byte		7th, 8th characters	
40009	Word	Color	1 to 14 (Please refer to Table 1)	
40010	Word	Input type	0 to 40 (Please refer to Table 2)	
40011	Word	Input filter	0 to 900 (0 to 900 sec)	
40012	Word	Unit	0 to 167 (Please refer to Table 3)	
40013	Word	Scaling	0: OFF, 1: ON	
40014	Word	Measuring start	-1000 to 5500 (Please refer to Table 4)	
40015	Word	Measuring end	-1000 to 5500 (Please refer to Table 4)	
40016	Word	Engineering start	-32767 to 32767	
40017	Word	Engineering end	-32767 to 32767	
40018	Word	Decimal point	0 to 4 (Please refer to Table 5)	
40019	Word	Square rooter	0: OFF, 1: ON	
40020	Word	Logarithmic display	0: OFF, 1: ON	
40021	Word	Subtract channel	0 to 30 (0: Subtract OFF, 1 to 30: channel 1 to 30)	
40022	Word	PV shift	-32767 to 32767	
40023	Word	PV gain	0 to 32767 (0.00 to 327.67%)	
40024	Word			Reserve
40025	Word			Reserve
40026	Word	Recording mode	0: With record, 1: Display only	
40027	Word	Recording type	0: Min-Max rec., 1: Point record, 2: Average rec.	
40028	Word	Range start	-32767 to 32767 (Please refer to Table 6)	
40029	Word	Range end	-32767 to 32767 (Please refer to Table 6)	
40030	Word			Reserve
40031	Word	Input channel	0 to 29 (channel 1 to 30)	
40032	Word			Reserve
40033	Word			Reserve
40034	Word			Reserve
40035	Word			Reserve
40036	Word	Fvalue calculation	0: OFF, 1: ON	
40037	Word	Totalize calculation	1: Totalizer, 2: Counter, 3: Timer	

Register No.	Data type	Memory contents	Read-out data / Write-in data setting range	Remarks
40038	Byte	Totalize tag	1st, 2nd characters	Set Totalize Tag (8 characters) by the ASCII code.
40039	Byte		3rd, 4th characters	
40040	Byte		5th, 6th characters	
40041	Byte		7th, 8th characters	
40042	Word	Totalize unit	0 to 167 (Please refer to Table 3)	
40043	Word	Totalize cut value	-32767 to 32767 (Please refer to Table 6)	
40044	Word	Totalize scale value	1 to 32767	
40045	Word	Totalize type	0 to 15 (Please refer to Table 7)	
40046	Word	Extern input	0 to 129 (Please refer to Table 8)	
40047	Word	Totalize base time	0: /s, 1: /min, 2: /h, 3: /day	
40048	Word	Reset operation	0: OFF, 1: ON	
40049	Word	Totalize reset input	0 to 130 (Please refer to Table 9)	
40050	Word			Reserve
to				Reserve
40065	Word	Channel 2 setting	Same allocation as in Channel 1	
to				
40129	Word	Channel 3 setting	Same allocation as in Channel 1	
to				
40193	Word	Channel 4 setting	Same allocation as in Channel 1	
to				
40257	Word	Channel 5 setting	Same allocation as in Channel 1	
to				
40321	Word	Channel 6 setting	Same allocation as in Channel 1	
to				
40385	Word	Channel 7 setting	Same allocation as in Channel 1	
to				
40449	Word	Channel 8 setting	Same allocation as in Channel 1	
to				
40513	Word	Channel 9 setting	Same allocation as in Channel 1	
to				
40577	Word	Channel 10 setting	Same allocation as in Channel 1	
to				
40641	Word	Channel 11 setting	Same allocation as in Channel 1	
to				
40705	Word	Channel 12 setting	Same allocation as in Channel 1	
to				
40769	Word	Channel 13 setting	Same allocation as in Channel 1	
to				
40833	Word	Channel 14 setting	Same allocation as in Channel 1	
to				
40897	Word	Channel 15 setting	Same allocation as in Channel 1	
to				
40961	Word	Channel 16 setting	Same allocation as in Channel 1	
to				
41025	Word	Channel 17 setting	Same allocation as in Channel 1	
to				
41089	Word	Channel 18 setting	Same allocation as in Channel 1	
to				
41153	Word	Channel 19 setting	Same allocation as in Channel 1	
to				

Register No.	Data type	Memory contents	Read-out data / Write-in data setting range	Remarks		
41217	Word	Channel 20 setting	Same allocation as in Channel 1			
to						
41281	Word	Channel 21 setting	Same allocation as in Channel 1			
to						
41345	Word	Channel 22 setting	Same allocation as in Channel 1			
to						
41409	Word	Channel 23 setting	Same allocation as in Channel 1			
to						
41473	Word	Channel 24 setting	Same allocation as in Channel 1			
to						
41537	Word	Channel 25 setting	Same allocation as in Channel 1			
to						
41601	Word	Channel 26 setting	Same allocation as in Channel 1			
to						
41665	Word	Channel 27 setting	Same allocation as in Channel 1			
to						
41729	Word	Channel 28 setting	Same allocation as in Channel 1			
to						
41793	Word	Channel 29 setting	Same allocation as in Channel 1			
to						
41857	Word	Channel 30 setting	Same allocation as in Channel 1			
to						
41921	Word	Channel 1 alarm setting (16 words)	Alarm type	0: OFF, 1: H alarm, 2: L alarm		
41922	Word		Alarm No. 1	Set point	-32767 to 32767 (Please refer to Table 6)	
41923	Word					Reserve
41924	Word			DO relay No.	0 to 28 (0: None, 1 to 28: DO 1 to 28)	
41925	Word		Alarm No. 2	Alarm type	0: OFF, 1: H alarm, 2: L alarm	
41926	Word			Set point	-32767 to 32767 (Please refer to Table 6)	
41927	Word					Reserve
41928	Word		Alarm No. 3	DO relay No.	0 to 28 (0: None, 1 to 28: DO 1 to 28)	
41929	Word			Alarm type	0: OFF, 1: H alarm, 2: L alarm	
41930	Word			Set point	-32767 to 32767 (Please refer to Table 6)	
41931	Word		Alarm No. 4			Reserve
41932	Word			DO relay No.	0 to 28 (0: None, 1 to 28: DO 1 to 28)	
41933	Word			Alarm type	0: OFF, 1: H alarm, 2: L alarm	
41934	Word			Set point	-32767 to 32767 (Please refer to Table 6)	
41935	Word					Reserve
41936	Word		DO relay No.	0 to 28 (0: None, 1 to 28: DO 1 to 28)		
41937	Word	Channel 2 alarm setting	Same allocation as in Channel 1			
to						
41953	Word	Channel 3 alarm setting	Same allocation as in Channel 1			
to						
41969	Word	Channel 4 alarm setting	Same allocation as in Channel 1			
to						
41985	Word	Channel 5 alarm setting	Same allocation as in Channel 1			
to						
42001	Word	Channel 6 alarm setting	Same allocation as in Channel 1			
to						
42017	Word	Channel 7 alarm setting	Same allocation as in Channel 1			
to						

Register No.	Data type	Memory contents	Read-out data / Write-in data setting range	Remarks
42033	Word	Channel 8 alarm setting	Same allocation as in Channel 1	
to				
42049	Word	Channel 9 alarm setting	Same allocation as in Channel 1	
to				
42065	Word	Channel 10 alarm setting	Same allocation as in Channel 1	
to				
42081	Word	Channel 11 alarm setting	Same allocation as in Channel 1	
to				
42097	Word	Channel 12 alarm setting	Same allocation as in Channel 1	
to				
42113	Word	Channel 13 alarm setting	Same allocation as in Channel 1	
to				
42129	Word	Channel 14 alarm setting	Same allocation as in Channel 1	
to				
42145	Word	Channel 15 alarm setting	Same allocation as in Channel 1	
to				
42161	Word	Channel 16 alarm setting	Same allocation as in Channel 1	
to				
42177	Word	Channel 17 alarm setting	Same allocation as in Channel 1	
to				
42193	Word	Channel 18 alarm setting	Same allocation as in Channel 1	
to				
42209	Word	Channel 19 alarm setting	Same allocation as in Channel 1	
to				
42225	Word	Channel 20 alarm setting	Same allocation as in Channel 1	
to				
42241	Word	Channel 21 alarm setting	Same allocation as in Channel 1	
to				
42257	Word	Channel 22 alarm setting	Same allocation as in Channel 1	
to				
42273	Word	Channel 23 alarm setting	Same allocation as in Channel 1	
to				
42289	Word	Channel 24 alarm setting	Same allocation as in Channel 1	
to				
42305	Word	Channel 25 alarm setting	Same allocation as in Channel 1	
to				
42321	Word	Channel 26 alarm setting	Same allocation as in Channel 1	
to				
42337	Word	Channel 27 alarm setting	Same allocation as in Channel 1	
to				
42353	Word	Channel 28 alarm setting	Same allocation as in Channel 1	
to				
42369	Word	Channel 29 alarm setting	Same allocation as in Channel 1	
to				
42385	Word	Channel 30 alarm setting	Same allocation as in Channel 1	
to				
42401	Word			Reserve
to				Reserve

Register No.	Data type	Memory contents		Read-out data / Write-in data setting range	Remarks	
42425	Byte	Display group 1 setting (18 words)	Display name	1st, 2nd characters	Set Display name (16 characters) by the ASCII code.	
42426	Byte			3rd, 4th characters		
42427	Byte			5th, 6th characters		
42428	Byte			7th, 8th characters		
42429	Byte			9th, 10th characters		
42430	Byte			11th, 12th characters		
42431	Byte			13th, 14th characters		
42432	Byte			15th, 16th characters		
42433	Word			Display No. 1		0: None, 1 to 30: ch 1 to 30
42434	Word			Display No. 2		0: None, 1 to 30: ch 1 to 30
42435	Word	Display No. 3	0: None, 1 to 30: ch 1 to 30			
42436	Word	Display No. 4	0: None, 1 to 30: ch 1 to 30			
42437	Word	Display No. 5	0: None, 1 to 30: ch 1 to 30			
42438	Word	Display No. 6	0: None, 1 to 30: ch 1 to 30			
42439	Word	Display No. 7	0: None, 1 to 30: ch 1 to 30			
42440	Word	Display No. 8	0: None, 1 to 30: ch 1 to 30			
42441	Word	Display No. 9	0: None, 1 to 30: ch 1 to 30			
42442	Word	Display No. 10	0: None, 1 to 30: ch 1 to 30			
42443	Word	Display group 2 setting		Same allocation as Display group 1		
to						
42461	Word	Display group 3 setting		Same allocation as Display group 1		
to						
42479	Word	Display group 4 setting		Same allocation as Display group 1		
to						
42497	Word				Reserve	
42498	Word	Display group 1 setting 2 (5 words)	Trend direction	0: Vertical, 1: Horizontal		
42499	Word		Channel index	0: CH No. disp., 1: Tag No. disp., 2: Unit Disp.		
42500	Word		Scale display	0: OFF, 1: ON		
42501	Word				Reserve	
42502	Word		Display divided	1 to 20		
42503	Word	Display group 2 setting 2		Same allocation as Display group 1		
to						
42508	Word	Display group 3 setting 2		Same allocation as Display group 1		
to						
42513	Word	Display group 4 setting 2		Same allocation as Display group 1		
to						
42518	Word	Display group 1 setting 3 (4 words)			Reserve	
42519	Word				Reserve	
42520	Word				Reserve	
42521	Word		Analog meter	0: Bar graph, 1: Analog meter		
42522	Word	Display group 2 setting 2		Same allocation as Display group 1		
to						
42526	Word	Display group 3 setting 2		Same allocation as Display group 1		
to						
42530	Word	Display group 4 setting 2		Same allocation as Display group 1		
to						
42534	Word				Reserve	
to					Reserve	
42541	Word				Reserve	

Register No.	Data type	Memory contents	Read-out data / Write-in data setting range	Remarks	
42542	Word	Totalize cycle	0 to 9 (Please refer to Table 10)		
42543	Word			Reserve	
42544	Word	Monthly base day	1 to 31 (1 to 31 days)		
42545	Word			Reserve	
42546	Word			Reserve	
42547	Word	External input	0 to 129 (Please refer to Table 8)		
42548	Word	H-P, L-P timer cycle	1 to 32767 (1 to 32767 min)		
42549	Word	AVG timer cycle	1 to 32767 (1 to 32767 min)		
42550	Word	SUM timer cycle	1 to 32767 (1 to 32767 min)		
42551	Word	Math CH 19 setting (36 words)	1st calculation	(Please refer to Table 11)	
42552	Word		Formula 1	Argument 1	
42553	Word			Argument 2	
42554	Word		Formula 1	2nd calculation	
42555	Word			Argument 1	
42556	Word		Argument 2		
42557	Word		Formula 1	3rd calculation	
42558	Word			Argument 1	
42559	Word		Argument 2		
42560	Word		Formula 2	1st calculation	
42561	Word			Argument 1	
42562	Word		Argument 2		
to					
42584	Word		Formula 4	3rd calculation	
42585	Word			Argument 1	
42586	Word			Argument 2	
42587	Word	Math channel 20 setting	Same allocation as Channel 19		
to					
42623	Word	Math channel 21 setting	Same allocation as Channel 19		
to					
42659	Word	Math channel 22 setting	Same allocation as Channel 19		
to					
42695	Word	Math channel 23 setting	Same allocation as Channel 19		
to					
42731	Word	Math channel 24 setting	Same allocation as Channel 19		
to					
42767	Word	Math channel 25 setting	Same allocation as Channel 19		
to					
42803	Word	Math channel 26 setting	Same allocation as Channel 19		
to					
42839	Word	Math channel 27 setting	Same allocation as Channel 19		
to					
42875	Word	Math channel 28 setting	Same allocation as Channel 19		
to					
42911	Word	Math channel 29 setting	Same allocation as Channel 19		
to					
42947	Word	Math channel 30 setting	Same allocation as Channel 19		
to					
42983	Word	Constant 1	Value	-32767 to 32767 (Please refer to Table 12)	
42984	Word		Decimal point	0 to 4	
to					

Register No.	Data type	Memory contents		Read-out data / Write-in data setting range	Remarks
43021	Word	Constant 20	Value	-32767 to 32767 (Please refer to Table 12)	
43022	Word		Decimal point	0 to 4	
43023	Word				Reserve
to					Reserve
43032	Word	Time setting	Time set request	1: Time set request. (Automatically clear)	Attention: Don't change the time absolutely during recording and totalizing.
43033	Word		Year	1 to 99 (2001 to 2099 year)	
43034	Word		Month	1 to 12 (1 to 12 month)	
43035	Word		Day	1 to 31 (1 to 31 day)	
43036	Word		Hour	0 to 23 (0 to 23 hour)	
43037	Word		Minute	0 to 59 (0 to 59 minute)	
43038	Word				Reserve
43039	Word				Reserve
43040	Word	Refreshment cycle		0 to 19 (Please refer to Table 13)	
43041	Word				Reserve
43042	Word	LCD lights-out time		0 to 60 (0: ON all the time, 1 to 60: 1 to 60 min)	
43043	Word	File division cycle		0 to 4 (Please refer to Table 14)	
43044	Word	Memory full alarm		0 to 28 (0: None, 1 to 28: DO 1 to 28)	
43045	Word	Record data format		0: ASCII, 1: Binary	
43046	Word	FValue calculation	Target temperature	-32767 to 32767 (-3276.7 to 3276.7°C)	
43047	Word		Z value	-32767 to 32767 (-3276.7 to 3276.7°C)	
43048	Word		Decimal point	0 to 4 (Please refer to Table 15)	
43049	Word				Reserve
43050	Word		Reset temperature	-32767 to 32767 (-3276.7 to 3276.7°C)	
43051	Word	Battery alarm		0 to 28 (0: None, 1 to 28: DO 1 to 28)	
43052	Word				Reserve
43053	Word	File overwrite		0: OFF, 1: ON	
43054	Word	Trend display compression		0: 1/1, 1: 1/10, 2: 1/30, 3: 1/60	
43055	Word				Reserve
43056	Word	Alarm hysteresis		0 to 10000 (0.00 to 100.00%)	
43057	Word	Alarm latch		0: OFF, 1: ON	
43058	Word	MODBUS Station No.		0 to 255 (0: Communication OFF)	
43059	Word	MODBUS baud rate		0: 9600 bps, 1: 19200 bps	
43060	Word	MODBUS parity		0: None, 1: Odd, 2: Even	
43061	Word	Configuration password		0 to 9999	
43062	Word	CF manager password		0 to 9999	
43063	Word	Record password		0 to 9999	
43064	Word				Reserve
43065	Word				Reserve
43066	Word				Reserve
43067	Word	Trend back color		0: White, 1: Black	
43068	Word	Historical back color		0: White, 1: Black	
to					Reserve
43081	Byte	Message No. 1 setting (22 Words)	Message	1st, 2nd characters	Set Message (32 characters) by the ASCII code.
43082	Byte			3rd, 4th characters	
43083	Byte			5th, 6th characters	
43084	Byte			7th, 8th characters	
43085	Byte			9th, 10th characters	
43086	Byte			11th, 12th characters	
43087	Byte			13th, 14th characters	
43088	Byte			15th, 16th characters	

Register No.	Data type	Memory contents		Read-out data / Write-in data setting range	Remarks
43089	Byte	Message No. 1 setting (22 Words)	Message	17th, 18th characters	
43090	Byte			19th, 20th characters	
43091	Byte			21st, 22nd characters	
43092	Byte			23rd, 24th characters	
43093	Byte			25th, 26th characters	
43094	Byte			27th, 28th characters	
43095	Byte			29th, 30th characters	
43096	Byte			31st, 32nd characters	
43097	Word				Reserve
43098	Word				Reserve
43099	Word		Message timing	0 to 2 (Please refer to Table 16)	
43100	Word		Message timing argument 1	0 to 9/0 to 29 (Please refer to Table 16)	
43101	Word		Message timing argument 2	0 to 3 (Please refer to Table 16)	
43102	Word				Reserve
43103	Word	Message No. 2 setting		Same allocation as Message No. 1	
to					
43125	Word	Message No. 3 setting		Same allocation as Message No. 1	
to					
43147	Word	Message No. 4 setting		Same allocation as Message No. 1	
to					
43169	Word	Message No. 5 setting		Same allocation as Message No. 1	
to					
43191	Word	Message No. 6 setting		Same allocation as Message No. 1	
to					
43213	Word	Message No. 7 setting		Same allocation as Message No. 1	
to					
43235	Word	Message No. 8 setting		Same allocation as Message No. 1	
to					
43257	Word	Message No. 9 setting		Same allocation as Message No. 1	
to					
43279	Word	Message No. 10 setting		Same allocation as Message No. 1	
to					
43301	Byte	Original unit 1 setting	1st, 2nd characters	Set original unit (7 characters) by the ASCII code.	
43302	Byte		3rd, 4th characters		
43303	Byte		5th, 6th characters		
43304	Byte		7th characters		
43305	Byte				Reserve
43306	Byte				Reserve
43307	Byte				Reserve
43308	Byte	Original unit 2 setting		Same allocation as Original unit 1	
to					
43315	Byte	Original unit 3 setting		Same allocation as Original unit 1	
to					
43322	Byte	Original unit 4 setting		Same allocation as Original unit 1	
to					
43329	Byte	Original unit 5 setting		Same allocation as Original unit 1	
to					
43336	Byte	Original unit 6 setting		Same allocation as Original unit 1	
to					
43343	Byte	Original unit 7 setting		Same allocation as Original unit 1	

Register No.	Data type	Memory contents		Read-out data / Write-in data setting range	Remarks
to					
43350	Byte	Original unit 8 setting		Same allocation as Original unit 1	
to					
43357	Byte	Original unit 9 setting		Same allocation as Original unit 1	
to					
43364	Byte	Original unit 10 setting		Same allocation as Original unit 1	
to					
43371	Byte	Original unit 11 setting		Same allocation as Original unit 1	
to					
43378	Byte	Original unit 12 setting		Same allocation as Original unit 1	
to					
43385	Word				Reserve
to					Reserve
43496	Word	DI 1 function		0 to 5 (Please refer to Table 17)	
43497	Word	DI 2 function		0 to 5	
43498	Word	DI 3 function		0 to 5	
43499	Word	DI 4 function		0 to 5	
43500	Word	DI 5 function		0 to 5	
43501	Word	DI 6 function		0 to 5	
43502	Word	DI 7 function		0 to 5	
43503	Word	DI 8 function		0 to 5	
43504	Word	DI 9 function		0 to 5	
43505	Word	DI 10 function		0 to 5	
43506	Word				Do not write
to					Do not write
44001	Byte	PILC data	1st, 2nd characters		Do not write
44002	Byte		3rd, 4th characters		Do not write
44003	Byte		5th, 6th characters		Do not write
44004	Byte		7th, 8th characters		Do not write
44005	Byte		9th, 10th characters		Do not write
44006	Byte		11th, 12th characters		Do not write
44007	Byte		13th, 14th characters		Do not write
44008	Byte		15th, 16th characters		Do not write
44009	Byte		17th, 18th characters		Do not write
44010	Byte		19th, 20th characters		Do not write
44011	Byte		21st, 22nd characters		Do not write
44012	Byte		23rd, 24th characters		Do not write
44013	Byte		25th, 26th characters		Do not write
44014	Byte		27th, 28th characters		Do not write
44015	Byte		29th, 30th characters		Do not write
44016	Byte		31st, 32nd characters		Do not write
44017	Byte	Serial number	1st, 2nd characters		Do not write
44018	Byte		3rd, 4th characters		Do not write
44019	Byte		5th, 6th characters		Do not write
44020	Byte		7th, 8th characters		Do not write
44021	Byte		9th, 10th characters		Do not write
44022	Byte		11th, 12th characters		Do not write
44023	Byte		13th, 14th characters		Do not write
44024	Byte		15th, 16th characters		Do not write
44025	Word				Do not write

Register No.	Data type	Memory contents	Read-out data / Write-in data setting range	Remarks
to				Do not write
Following register No. 45000 to 45500 will not be recorded in the main unit.				
45000	Word	Register data request	1: Register data (Automatically clear)	
45001	Word			Reserve
45002	Word	Fvalue calculation reset request	1: Fvalue reset (Automatically clear)	
45003	Word	Prohibiting the writing to the memory card	0: Writing permission, 1: Writing prohibition	
45004	Bit	Recorder control	(Please refer to Table 18)	
45005	Bit	Message request	(Please refer to Table 19)	
45006	Word	Totalize reset request	1: Totalize reset (Automatically clear)	
45007	Word	Alarm latch clear request	1: Alarm latch clear (Automatically clear)	
45008	Word			Do not write
to				Do not write
45051	Bit	Totalize reset request of each channel	Channel 1 to 16	(Please refer to Table 20)
45052	Bit		Channel 17 to 30	
45053	Word			Reserve
to				Reserve
45061	Word	Communication input 1: M01	-32767 to 32767	
45062	Word	Communication input 2: M02	-32767 to 32767	
45063	Word	Communication input 3: M03	-32767 to 32767	
45064	Word	Communication input 4: M04	-32767 to 32767	
45065	Word	Communication input 5: M05	-32767 to 32767	
45066	Word	Communication input 6: M06	-32767 to 32767	
45067	Word	Communication input 7: M07	-32767 to 32767	
45068	Word	Communication input 8: M08	-32767 to 32767	
45069	Word	Communication input 9: M09	-32767 to 32767	
45070	Word	Communication input 10: M10	-32767 to 32767	
45071	Word	Communication input 11: M11	-32767 to 32767	
45072	Word	Communication input 12: M12	-32767 to 32767	
to				Do not write
The following addresses are recorded in the main unit.				
45501	Word			Reserve
45502	Word	E-mail function	0: OFF, 1: ON	
45503	Word	FTP server function	0: OFF, 1: ON	
45504	Word	FTP access control	0: OFF, 1: ON	
45505	Word	Web server function	0: OFF, 1: ON	
45506	Word			Reserve
45507	Word			Reserve
45508	Word	MODBUS TCP/IP function	0: OFF, 1: ON	
45509	Word	IP address	1st number	0 to 255
45510	Word		2nd number	0 to 255
45511	Word		3rd number	0 to 255
45512	Word		4th number	0 to 255
45513	Word	Subnet mask	1st number	0 to 255
45514	Word		2nd number	0 to 255
45515	Word		3rd number	0 to 255
45516	Word		4th number	0 to 255

Register No.	Data type	Memory contents	Read-out data / Write-in data setting range	Remarks	
45517	Word	Default gateway	1st number	0 to 255	
45518	Word		2nd number	0 to 255	
45519	Word		3rd number	0 to 255	
45520	Word		4th number	0 to 255	
45521	Word	SMTP IP address	1st number	0 to 255	
45522	Word		2nd number	0 to 255	
45523	Word		3rd number	0 to 255	
45524	Word		4th number	0 to 255	
45525	Byte	Sender's mail address	1st, 2nd characters	Set address (64 characters) by the ASCII code.	
45526	Byte		3rd, 4th characters		
45527	Byte		5th, 6th characters		
45528	Byte		7th, 8th characters		
45529	Byte		9th, 10th characters		
45530	Byte		11th, 12th characters		
45531	Byte		13th, 14th characters		
45532	Byte		15th, 16th characters		
45533	Byte		17th, 18th characters		
45534	Byte		19th, 20th characters		
45535	Byte		21st, 22nd characters		
45536	Byte		23rd, 24th characters		
45537	Byte		25th, 26th characters		
45538	Byte		27th, 28th characters		
45539	Byte		29th, 30th characters		
45540	Byte		31st, 32nd characters		
45541	Byte		33rd, 34th characters		
45542	Byte		35th, 36th characters		
45543	Byte		37th, 38th characters		
45544	Byte		39th, 40th characters		
45545	Byte		41st, 42nd characters		
45546	Byte		43rd, 44th characters		
45547	Byte		45th, 46th characters		
45548	Byte		47th, 48th characters		
45549	Byte		49th, 50th characters		
45550	Byte		51st, 52nd characters		
45551	Byte		53rd, 54th characters		
45552	Byte		55th, 56th characters		
45553	Byte		57th, 58th characters		
45554	Byte		59th, 60th characters		
45555	Byte		61st, 62nd characters		
45556	Byte		63rd, 64th characters		
45557	Byte	Sender's mail name	1st, 2nd characters	Set name (32 characters) by the ASCII code.	
45558	Byte		3rd, 4th characters		
45559	Byte		5th, 6th characters		
45560	Byte		7th, 8th characters		
45561	Byte		9th, 10th characters		
45562	Byte		11th, 12th characters		
45563	Byte		13th, 14th characters		
45564	Byte		15th, 16th characters		
45565	Byte		17th, 18th characters		
45566	Byte		19th, 20th characters		

Register No.	Data type	Memory contents	Read-out data / Write-in data setting range	Remarks
45567	Byte	Sender's mail name	21st, 22nd characters	
45568	Byte		23rd, 24th characters	
45569	Byte		25th, 26th characters	
45570	Byte		27th, 28th characters	
45571	Byte		29th, 30th characters	
45572	Byte		31st, 32nd characters	
45573	Byte	Receiver's mail address 1	1st, 2nd characters	Set address (64 characters) by the ASCII code.
45574	Byte		3rd, 4th characters	
45575	Byte		5th, 6th characters	
45576	Byte		7th, 8th characters	
45577	Byte		9th, 10th characters	
45578	Byte		11th, 12th characters	
45579	Byte		13th, 14th characters	
45580	Byte		15th, 16th characters	
45581	Byte		17th, 18th characters	
45582	Byte		19th, 20th characters	
45583	Byte		21st, 22nd characters	
45584	Byte		23rd, 24th characters	
45585	Byte		25th, 26th characters	
45586	Byte		27th, 28th characters	
45587	Byte		29th, 30th characters	
45588	Byte		31st, 32nd characters	
45589	Byte		33rd, 34th characters	
45590	Byte		35th, 36th characters	
45591	Byte		37th, 38th characters	
45592	Byte		39th, 40th characters	
45593	Byte		41st, 42nd characters	
45594	Byte		43rd, 44th characters	
45595	Byte		45th, 46th characters	
45596	Byte		47th, 48th characters	
45597	Byte		49th, 50th characters	
45598	Byte		51st, 52nd characters	
45599	Byte		53rd, 54th characters	
45600	Byte		55th, 56th characters	
45601	Byte		57th, 58th characters	
45602	Byte		59th, 60th characters	
45603	Byte		61st, 62nd characters	
45604	Byte		63rd, 64th characters	
45605	Byte	Receiver's mail address 2	Same allocation as Receiver's mail address 1	
to				
45637	Byte	Receiver's mail address 3	Same allocation as Receiver's mail address 1	
to				
45669	Byte	Receiver's mail address 4	Same allocation as Receiver's mail address 1	
to				
45701	Byte	Receiver's mail address 5	Same allocation as Receiver's mail address 1	
to				
45733	Byte	Receiver's mail address 6	Same allocation as Receiver's mail address 1	
to				
45765	Byte	Receiver's mail address 7	Same allocation as Receiver's mail address 1	
to				

Register No.	Data type	Memory contents		Read-out data / Write-in data setting range	Remarks	
45797	Byte	Receiver's mail address 8		Same allocation as Receiver's mail address 1		
to						
45829	Word				Reserve	
to					Reserve	
45901	Byte	User 1 setting	User name	1st, 2nd characters	Set name (16 characters) by the ASCII code.	
45902	Byte			3rd, 4th characters		
45903	Byte			5th, 6th characters		
45904	Byte			7th, 8th characters		
45905	Byte			9th, 10th characters		
45906	Byte			11th, 12th characters		
45907	Byte			13th, 14th characters		
45908	Byte			15th, 16th characters		
45909	Byte		Password	1st, 2nd characters	Set password (8 characters) by the ASCII code.	
45910	Byte			3rd, 4th characters		
45911	Byte			5th, 6th characters		
45912	Byte			7th, 8th characters		
45913	Word		User level		0: Administrator, 1: Guest	
45914	Word					Reserve
45915	Byte	User 2 setting		Same allocation as User 1		
to						
45929	Byte	User 3 setting		Same allocation as User 1		
to						
45943	Byte	User 4 setting		Same allocation as User 1		
to						
45957	Byte	User 5 setting		Same allocation as User 1		
to						
45971	Byte	User 6 setting		Same allocation as User 1		
to						
45985	Byte	User 7 setting		Same allocation as User 1		
to						
45999	Byte	User 8 setting		Same allocation as User 1		
to						
46013	Word				Reserve	
to					Reserve	
46101	Byte	E-mail trigger 1 setting	Title	1st, 2nd characters	Set title (32 characters) by the ASCII code.	
46102	Byte			3rd, 4th characters		
46103	Byte			5th, 6th characters		
46104	Byte			7th, 8th characters		
46105	Byte			9th, 10th characters		
46106	Byte			11th, 12th characters		
46107	Byte			13th, 14th characters		
46108	Byte			15th, 16th characters		
46109	Byte			17th, 18th characters		
46110	Byte			19th, 20th characters		
46111	Byte			21st, 22nd characters		
46112	Byte			23rd, 24th characters		
46113	Byte			25th, 26th characters		
46114	Byte			27th, 28th characters		
46115	Byte			29th, 30th characters		
46116	Byte			31st, 32nd characters		

Register No.	Data type	Memory contents	Read-out data / Write-in data setting range	Remarks
46117	Byte	Text 1	1st, 2nd characters	Set text 1 (32 characters) by the ASCII code.
46118	Byte		3rd, 4th characters	
46119	Byte		5th, 6th characters	
46120	Byte		7th, 8th characters	
46121	Byte		9th, 10th characters	
46122	Byte		11th, 12th characters	
46123	Byte		13th, 14th characters	
46124	Byte		15th, 16th characters	
46125	Byte		17th, 18th characters	
46126	Byte		19th, 20th characters	
46127	Byte		21st, 22nd characters	
46128	Byte		23rd, 24th characters	
46129	Byte		25th, 26th characters	
46130	Byte		27th, 28th characters	
46131	Byte		29th, 30th characters	
46132	Byte		31st, 32nd characters	
46133	Byte	Text 2	1st, 2nd characters	Set text 2 (32 characters) by the ASCII code.
46134	Byte		3rd, 4th characters	
46135	Byte		5th, 6th characters	
46136	Byte		7th, 8th characters	
46137	Byte		9th, 10th characters	
46138	Byte		11th, 12th characters	
46139	Byte		13th, 14th characters	
46140	Byte		15th, 16th characters	
46141	Byte		17th, 18th characters	
46142	Byte		19th, 20th characters	
46143	Byte		21st, 22nd characters	
46144	Byte		23rd, 24th characters	
46145	Byte		25th, 26th characters	
46146	Byte		27th, 28th characters	
46147	Byte		29th, 30th characters	
46148	Byte		31st, 32nd characters	
46149	Word	Trigger timing	(Please refer to Table 21)	
46150	Word	Trigger timing argument 1		
46151	Word	Trigger timing argument 2		
46152	Word	PV value affixation	0: OFF, 1: ON	
46153	Word	Receiver's mail address No.	(Please refer to Table 22)	
46154	Word			Reserve
46155	Byte	E-mail trigger 2 setting	Same allocation as E-mail trigger 1	
to				
46209	Byte	E-mail trigger 3 setting	Same allocation as E-mail trigger 1	
to				
46263	Byte	E-mail trigger 4 setting	Same allocation as E-mail trigger 1	
to				
46317	Byte	E-mail trigger 5 setting	Same allocation as E-mail trigger 1	
to				
46371	Byte	E-mail trigger 6 setting	Same allocation as E-mail trigger 1	
to				
46425	Byte	E-mail trigger 7 setting	Same allocation as E-mail trigger 1	
to				

Register No.	Data type	Memory contents	Read-out data / Write-in data setting range	Remarks
46479	Byte	E-mail trigger 8 setting	Same allocation as E-mail trigger 1	
to				
46533	Byte	E-mail trigger 9 setting	Same allocation as E-mail trigger 1	
to				
46587	Byte	E-mail trigger 10 setting	Same allocation as E-mail trigger 1	
to				
46641	Word			Reserve
to				Reserve
47000	Word	Final address		Reserve

7.2.2 Word data [read-out only] : Function code [04H]

Register No.	Data type	Memory contents	Read-out data	Remarks
3 xxxx				
30001	Bit	System information	(Please refer to Table 23)	
30002	Bit			Reserve
30003	Bit	DO information	DO 1 to 16	(Please refer to Table 24)
30004	Bit		DO 17 to 28	
30005	Bit			Reserve
30006	Bit	DI information		(Please refer to Table 25)
to				Reserve
30086	Word	Memory cord utilization	0 to 1000 (0.00 to 100.0%, 100.0% = Memory FULL)	
to				Reserve
30093	Bit	Channel alarm information	Channel 1 to 4	(Please refer to Table 26)
30094	Bit		Channel 5 to 8	
30095	Bit		Channel 9 to 12	
30096	Bit		Channel 13 to 16	
30097	Bit		Channel 17 to 20	
30098	Bit		Channel 21 to 24	
30099	Bit		Channel 25 to 28	
30100	Bit		Channel 29 to 30	
30101	Word	Measured value	Channel 1	-32767 to 32767 (No decimal point)
30102	Word		Channel 2	-32767 to 32767 (No decimal point)
30103	Word		Channel 3	-32767 to 32767 (No decimal point)
to				
30129	Word		Channel 29	-32767 to 32767 (No decimal point)
30130	Word		Channel 30	-32767 to 32767 (No decimal point)
30131	Word	Channel status	Channel 1	0: Normal, 1: Burnout, 2: Over, 3: Under, 4: Error
30132	Word		Channel 2	0: Normal, 1: Burnout, 2: Over, 3: Under, 4: Error
30133	Word		Channel 3	0: Normal, 1: Burnout, 2: Over, 3: Under, 4: Error
to				
30160	Word		Channel 30	0: Normal, 1: Burnout, 2: Over, 3: Under, 4: Error
30161	Long	Totalizing value	Channel 1	-999999999 to 999999999 (No decimal point)
30162	Long		Channel 1	
30163	Long		Channel 2	-999999999 to 999999999 (No decimal point)
30164	Long		Channel 2	
to				

Register No.	Data type	Memory contents		Read-out data	Remarks
30219	Long		Channel 30	-999999999 to 999999999 (No decimal point)	
30220	Long		Channel 30		
30221	Long	Totalizing start time	Channel 1	Greenwich Time	
30222	Long		Channel 1		
30223	Long		Channel 2	Greenwich Time	
30224	Long		Channel 2		
to					
30279	Long		Channel 30	Greenwich Time	
30280	Long		Channel 30		
30281	Long	Totalizing end time	Channel 1	Greenwich Time	
30282	Long		Channel 1		
30283	Long		Channel 2	Greenwich Time	
30284	Long		Channel 2		
to					
30339	Long		Channel 30	Greenwich Time	
30340	Long		Channel 30		
30341	Long	Previous totalized value	Channel 1	-999999999 to 999999999 (No decimal point)	
30342	Long		Channel 1		
30343	Long		Channel 2	-999999999 to 999999999 (No decimal point)	
30344	Long		Channel 2		
to					
30399	Long		Channel 30	-999999999 to 999999999 (No decimal point)	
30400	Long		Channel 30		
30401	Long	Previous totalized start time	Channel 1	Greenwich Time	
30402	Long		Channel 1		
30403	Long		Channel 2	Greenwich Time	
30404	Long		Channel 2		
to					
30459	Long		Channel 30	Greenwich Time	
30460	Long		Channel 30		
30461	Long	Previous totalized end time	Channel 1	Greenwich Time	
30462	Long		Channel 1		
30463	Long		Channel 2	Greenwich Time	
30464	Long		Channel 2		
to					
30519	Long		Channel 30	Greenwich Time	
30520	Long		Channel 30		
30521	Word				Reserve
to					Reserve
32000	Word	Final address			Reserve

- Notes) • The area marked (Do not write) is a system area. Do not write in there.
• Write 0 into the areas without data.

7.3 Additional Explanation of Address Map

Table 1 Channel color code

Data	color
1	Red
2	Blue
3	Violet
4	Green
5	Sky blue
6	Yellow
7	Gray
8	Indigo
9	Dark red
10	Purple
11	Deep green
12	Pale blue
13	Yellowish green
14	Silver

Table 2 Input type code

Data	Input type		Initial decimal point
0	Skip	Skip	0
1	K-Type TC	Thermocouple	1
2	E-Type TC		
3	J-Type TC		
4	T-Type TC		
5	R-Type TC		
6	S-Type TC		
7	B-Type TC		
8	N-Type TC		
9	W-Type TC		
10	L-Type TC		
11	U-Type TC		
12	PN-Type TC		
20	Pt100	Resistance bulb	1
21	JPt100		
30	50 mV	DC voltage	2
31	500 mV		1
32	1-5 V		3
33	0-5 V		
40	Other channel	Other channel	0

Note) When position of decimal point varies with input type, initialize it.

Table 3 Unit code

Data	Unit	Data	Unit	Data	Unit	Data	Unit	Data	Unit
0	°C	18	t/min	36	mPa	54	mm2	72	ppm
1	°F	19	kg/min	37	Pa	55	cm2	73	ppmNH3
2	%RH	20	g/min	38	kPa	56	m2	74	ppmSO2
3	vol%	21	m3/min	39	MPa	57	g	75	ppmH2S
4		22	l/min	40		58	kg	76	ppmCO
5		23		41		59	t	77	ppmO2
6	t/d	24	t/s	42	mm	60	g/cm3	78	ppmNOx
7	kg/d	25	kg/s	43	cm	61	kg/cm3	79	ppb
8	g/d	26	g/s	44	m	62	g/m3	80	pH
9	m3/d	27	m3/s	45		63	kg/m3	81	mol
10	l/d	28	l/s	46		64		82	%
11		29		47		65		83	%H2
12	t/h	30	mbar	48	ml	66	g/l	84	%CO2
13	kg/h	31	bar	49	L	67	kg/l	85	%He
14	g/h	32	N/mm2	50	kl	68	g/ml	86	%Ar
15	m3/h	33	N/m2	51	mm3	69		87	%O2
16	l/h	34		52	cm3	70		88	%NaCl
17		35		53	m3	71		89	%CO

Data	Unit	Data	Unit	Data	Unit	Data	Unit	Data	Unit
90	mN	108	us	126	Var	144	uSv/h	162	*Unit 7
91	N	109	ms	127	kVar	145	mSv/h	163	*Unit 8
92	N · m	110	s	128	uS/cm	146	nGy/h	164	*Unit 9
93	J	111	min	129	uF	147	uGy/h	165	*Unit 10
94	kJ	112	h	130	F	148	um	166	*Unit 11
95		113	day	131	C	149		167	*Unit 12
96	mm/s	114	mV	132	mH	150	Pa · s		
97	mm/min	115	V	133	H	151	mPa · s		
98	mm/h	116	kV	134	m ohm	152			
99	m/s	117	uA	135	ohm	153			
100	m/min	118	mA	136	k ohm	154			
101	m/h	119	A	137	M ohm	155			
102	rps	120	Hz	138	lx	156	*Unit 1		
103	rpm	121	dB	139	cd	157	*Unit 2		
104	rph	122	W	140	lm	158	*Unit 3		
105	m/s2	123	kW	141	cd/m2	159	*Unit 4		
106	rad/s	124	VA	142		160	*Unit 5		
107	km/h	125	kVA	143		161	*Unit 6		

* The unit that was made in Unit 1 to 12: Original unit definition is selected.

Table 4 Measuring start, measuring end setting limit

Input type	Measuring start, measuring end limit
50 mV	-1000 to 5500 (-10.00 to 55.00 mV)
500 mV	-100 to 5500 (-10.0 to 550.0 mV)
1-5 V	500 to 5500 (0.500 to 5.500 V)
0-5 V	-100 to 5500 (-0.100 to 5.500 V)

Table 5 Decimal point code

Decimal point data	Setting data
0	-32767 to 32767
1	-3276.7 to 3276.7
2	-327.67 to 327.67
3	-32.767 to 32.767
4	-3.2767 to 3.2767

Table 6 Data setting limit

- With Fvalue calculation OFF

Input type TC, Pt

Input type	°C (Centigrade)	°F (Fahrenheit)
	Range start, Range end Alarm No.1 to 4 set point Totalize cut value	Range start, Range end Alarm No.1 to 4 set point Totalize cut value
K-Type TC	-2300 to 14000 (-230.0 to 1400.0°C)	-3820 to 25520 (-382.0 to 2552.0°F)
E-Type TC	-2300 to 8300 (-230.0 to 830.0°C)	-3820 to 15260 (-382.0 to 1526.0°F)
J-Type TC	-2300 to 11300 (-230.0 to 1130.0°C)	-3820 to 20660 (-382.0 to 2066.0°F)
T-Type TC	-2300 to 4300 (-230.0 to 430.0°C)	-3820 to 8060 (-382.0 to 806.0°F)
R-Type TC	-300 to 17900 (-30.0 to 1790.0°C)	-220 to 32540 (-22.0 to 3254.0°F)
S-Type TC	-300 to 17900 (-30.0 to 1790.0°C)	-220 to 32540 (-22.0 to 3254.0°F)
B-Type TC	3700 to 17900 (370.0 to 1790.0°C)	6980 to 32540 (698.0 to 3254.0°F)
N-Type TC	-300 to 13300 (-30.0 to 1330.0°C)	-220 to 24260 (-22.0 to 2426.0°F)
W-Type TC	-300 to 17900 (-30.0 to 1790.0°C)	-220 to 32540 (-22.0 to 3254.0°F)
L-Type TC	-2300 to 9300 (-230.0 to 930.0°C)	-3820 to 17060 (-382.0 to 1706.0°F)
U-Type TC	-2300 to 4300 (-230.0 to 430.0°C)	-3820 to 8060 (-382.0 to 806.0°F)
PN-Type TC	-300 to 13300 (-30.0 to 1330.0°C)	-220 to 24260 (-22.0 to 2426.0°F)
Pt100	-2300 to 6300 (-230.0 to 630.0°C)	-3820 to 11660 (-382.0 to 1166.0°F)
JPt100	-2300 to 6300 (-230.0 to 630.0°C)	-3820 to 11660 (-382.0 to 1166.0°F)

Input type Volt

Input type	Scaling OFF	Scaling ON
	Range start, Range end Alarm No.1 to 4 set point Totalize cut value	Range start, Range end Alarm No.1 to 4 set point Totalize cut value
50 mV	-1000 to 5500 (-10.00 to 55.00 mV)	-32767 to 32767 (Please refer to Table 5)
500 mV	-100 to 5500 (-10.0 to 550.0 mV)	
1-5 V	500 to 5500 (0.500 to 5.500 V)	
0-5 V	-100 to 5500 (-0.100 to 5.500 V)	

- With Fvalue calculation ON or Input type other channel

Input type	Range start, Range end Alarm No.1 to 4 set point Totalize cut value
All type	-32767 to 32767 (Please refer to Table 15)

Table 7 Totalize type code

Data	Totalize type
0	Daily
1	Monthly
3	Annual
6	External
15	OFF

Table 8 Totalize input and External input code

Data	Input	Data	Input
0	DI 1	10	CH 1 Alarm No.1
1	DI 2	11	CH 1 Alarm No.2
2	DI 3	12	CH 1 Alarm No.3
3	DI 4	13	CH 1 Alarm No.4
4	DI 5	14	CH 2 Alarm No.1
5	DI 6		?
6	DI 7	126	CH30 Alarm No.1
7	DI 8	127	CH30 Alarm No.2
8	DI 9	128	CH30 Alarm No.3
9	DI 10	129	CH30 Alarm No.4

Table 9 Totalize reset input code

Data	Input	Data	Input
0	None	11	CH 1 Alarm No.1
1	DI 1	12	CH 1 Alarm No.2
2	DI 2	13	CH 1 Alarm No.3
3	DI 3	14	CH 1 Alarm No.4
4	DI 4	15	CH 2 Alarm No.1
5	DI 5		∅
6	DI 6		∅
7	DI 7	127	CH30 Alarm No.1
8	DI 8	128	CH30 Alarm No.2
9	DI 9	129	CH30 Alarm No.3
10	DI 10	130	CH30 Alarm No.4

Table 10 Totalize cycle code

Data	Totalize type
0	10 min
1	20 min
2	30 min
3	1 hour
4	2 hour
5	3 hour
6	4 hour
7	6 hour
8	12 hour
9	24 hour

Table 11 Formula code

Calculation data = four rules calculation data + function data * 256

Data	Function data	Data	Four rules calculation data
0	None	0	Formula end
1	ABS	1	+ (Please set it to the 1st calculation)
2	POW	2	-
3	SQR	3	*
4	LOG	4	/
5	LN		
6	EXP		
7	RH		
8	MAX		
9	MIN		
10	H-P		
11	L-P		
12	AVG		
13	SUM		

Argument 1, 2 data = argument type * 256 + data number

Data	Argument type	Data number limit
0	Input channel	0 to 29 (Channel 1 to 30: C01 to C30)
1	Totalizer input	0 to 29 (Channel totalizer 1 to 30: T01 to T30)
2	Digital input	0 to 9 (DI 1 to 10: D01 to D10)
3	Communication input	0 to 11 (Communication input 1 to 12: M01 to M12)
4	Constant	0 to 19 (Constant 1 to 20: K01 to K20)
5	Temporary data	0 to 2 (Temporary data 1 to 3: B01 to B03)

Ex.) When setting “POW (C01, T02)*K03” in Formula 1 of Channel 19, set the following data.

Address	Data	Display	Breakdown
42551	513	(+)POW	Four rules calc. data: “+” (1) + Function data: “POW”(2 * 256)
42552	0	C01	Argument type: Input channel (0 * 256) + Data number: 1 (0)
42553	257	T02	Argument type: Totalizer input (1 * 256) + Data number: 2 (1)
42554	3	*	Four rules calc. data: “*” (3) + Function data: none (0 * 256)
42555	1026	K03	Argument type: Constant (4 * 256) + Data number: 3 (2)
42556	0	(none)	
42557	0	(End)	
42558	0	(none)	
42559	0	(none)	

Table12 Constant data

Decimal point data	Constant data
0	-32767 to 32767
1	-3276.7 to 3276.7
2	-327.67 to 327.67
3	-32.767 to 32.767
4	-3.2767 to 3.2767

Table 13 Refreshment cycle code

Data	Refreshment cycle
0	1 sec
1	2 sec
2	3 sec
3	5 sec
4	10 sec
5	20 sec
6	30 sec
7	1 min
8	2 min
9	3 min
10	5 min
11	10 min
12	20 min
13	30 min
14	1 hour
15	2 hour
16	3 hour
17	4 hour
18	6 hour
19	12 hour

Table14 File division cycle code

Data	File division cycle
0	No division
1	1 hour
2	1 day
3	1 week
4	1 month

Table15 FValue calculation decimal point code

Decimal point data	FValue calculation ON channel data
0	-32767 to 32767
1	-3276.7 to 3276.7
2	-327.67 to 327.67
3	-32.767 to 32.767
4	-3.2767 to 3.2767

Table 16 Message timing data

Message timing argument 1 and 2 have a significant difference according to the contents of Message timing.

Data	Message timing	Argument 1 (DI No./Alarm channel)	Argument 2 (Alarm No.)
0	None	None	None
1	DI ON	0 to 9 (DI1 to 10)	None
2	DI OFF	0 to 9 (DI1 to 10)	None
3	Alarm ON	0 to 29 (Channel 1 to 30)	0 to 3 (Alarm No.1 to 4)
4	Alarm OFF	0 to 29 (Channel 1 to 30)	0 to 3 (Alarm No.1 to 4)

Table 17 DI function code

Data	DI function
0	Function invalid
1	Rec start/Rec stop
2	Fvalue calc. reset
3	Totalize start/stop
4	Totalize reset
5	LCD ON

Table 18 Recorder control

Bit	Contents	Write data
0	Record start/stop	0: Record stop, 1: Record start
1	Reserve	
2	Totalize start/stop	0: Totalize stop, 1: Totalize start
3	LCD Lighting	0: No change, 1: LCD Lighting
4	Reserve	
5	Reserve	
6	Reserve	
7	Reserve	
8	Reserve	
9	Reserve	
10	Reserve	
11	Reserve	
12	Reserve	
13	Reserve	
14	Reserve	
15	Reserve	

Table 19 Message request

Bit	Contents	Write data
0	Message No.1 request	0: No change, 1: Message request
1	Message No.2 request	0: No change, 1: Message request
2	Message No.3 request	0: No change, 1: Message request
3	Message No.4 request	0: No change, 1: Message request
4	Message No.5 request	0: No change, 1: Message request
5	Message No.6 request	0: No change, 1: Message request
6	Message No.7 request	0: No change, 1: Message request
7	Message No.8 request	0: No change, 1: Message request
8	Message No.9 request	0: No change, 1: Message request
9	Message No.10 request	0: No change, 1: Message request
10	Reserve	
11	Reserve	
12	Reserve	
13	Reserve	
14	Reserve	
15	Reserve	

Table 20 Totalize reset request per channel

Write data 0: No change, 1: Totalize reset request

Bit	Address 45051	Address 45052
0	Channel 1	Channel 17
1	Channel 2	Channel 18
2	Channel 3	Channel 19
3	Channel 4	Channel 20
4	Channel 5	Channel 21
5	Channel 6	Channel 22
6	Channel 7	Channel 23
7	Channel 8	Channel 24
8	Channel 9	Channel 25
9	Channel 10	Channel 26
10	Channel 11	Channel 27
11	Channel 12	Channel 28
12	Channel 13	Channel 29
13	Channel 14	Channel 30
14	Channel 15	Reserve
15	Channel 16	Reserve

Table 21 E-mail trigger timing data

Argument 1 and 2 have a significant difference according to the contents of E-mail trigger timing.

Data	Trigger timing	Argument 1	Argument 2
0	None	None	None
1	DI ON	0 to 9 (DI 1 to 10)	None
2	DI OFF	0 to 9 (DI 1 to 10)	None
3	Alarm ON	0 to 29 (Channel 1 to 30)	0 to 3 (Alarm No. 1 to 4)
4	Alarm OFF	0 to 29 (Channel 1 to 30)	0 to 3 (Alarm No. 1 to 4)
5	Warning	0 to 3 0: Alarm ON (All ch) 1: All warning 2: No battery 3: CF full	None
6	Timer cycle	0 to 6 0: 1 hour 1: 2 hour 2: 3 hour 3: 4 hour 4: 6 hour 5: 12 hour 6: 1 day	0 to 23 (Base time 0:00 to 23:00)

Table 22 Receiver's mail address No.

Bit	Contnets	Data
0	E-mail address No. 1	0: No receive; 1: Address to receive
1	E-mail address No. 2	0: No receive; 1: Address to receive
2	E-mail address No. 3	0: No receive; 1: Address to receive
3	E-mail address No. 4	0: No receive; 1: Address to receive
4	E-mail address No. 5	0: No receive; 1: Address to receive
5	E-mail address No. 6	0: No receive; 1: Address to receive
6	E-mail address No. 7	0: No receive; 1: Address to receive
7	E-mail address No. 8	0: No receive; 1: Address to receive
8	Reserve	
9	Reserve	
10	Reserve	
11	Reserve	
12	Reserve	
13	Reserve	
14	Reserve	
15	Reserve	

Table 23 System information

Bit	Contents	Read data
0	Recording status	0: Stop, 1: Recording
1	CF card capacity	0: Capacity available, 1: No capacity
2	Channel alarming status	0: OFF, 1: ON
3	Reserve	
4	Reserve	
5	LCD state	0: ON, 1: OFF
6	Reserve	
7	Totalizing condition	0: Stop, 1: Totalizing
8	Battery condition	0: Provided, 1: Not provided
9	Reserve	
10	CF card status	0: None, 1: Exist
11	Reserve	
12	Reserve	
13	Reserve	
14	Reserve	
15	Reserve	

Table 24 DO information

Bit	Address 30003		Address 30004	
	Contents	Read data	Contents	Read data
0	DO 1 information	0: OFF, 1: ON	DO 17 information	0: OFF, 1: ON
1	DO 2 information	0: OFF, 1: ON	DO 18 information	0: OFF, 1: ON
2	DO 3 information	0: OFF, 1: ON	DO 19 information	0: OFF, 1: ON
3	DO 4 information	0: OFF, 1: ON	DO 20 information	0: OFF, 1: ON
4	DO 5 information	0: OFF, 1: ON	DO 21 information	0: OFF, 1: ON
5	DO 6 information	0: OFF, 1: ON	DO 22 information	0: OFF, 1: ON
6	DO 7 information	0: OFF, 1: ON	DO 23 information	0: OFF, 1: ON
7	DO 8 information	0: OFF, 1: ON	DO 24 information	0: OFF, 1: ON
8	DO 9 information	0: OFF, 1: ON	DO 25 information	0: OFF, 1: ON
9	DO 10 information	0: OFF, 1: ON	DO 26 information	0: OFF, 1: ON
10	DO 11 information	0: OFF, 1: ON	DO 27 information	0: OFF, 1: ON
11	DO 12 information	0: OFF, 1: ON	DO 28 information	0: OFF, 1: ON
12	DO 13 information	0: OFF, 1: ON	Reserve	
13	DO 14 information	0: OFF, 1: ON	Reserve	
14	DO 15 information	0: OFF, 1: ON	Reserve	
15	DO 16 information	0: OFF, 1: ON	Reserve	

Table 25 DI information

Bit	Contents	Read data
0	DI 1 information	0:OFF, 1:ON
1	DI 2 information	0:OFF, 1:ON
2	DI 3 information	0:OFF, 1:ON
3	DI 4 information	0:OFF, 1:ON
4	DI 5 information	0:OFF, 1:ON
5	DI 6 information	0:OFF, 1:ON
6	DI 7 information	0:OFF, 1:ON
7	DI 8 information	0:OFF, 1:ON
8	DI 9 information	0:OFF, 1:ON
9	DI 10 information	0:OFF, 1:ON
10	Reserve	
11	Reserve	
12	Reserve	
13	Reserve	
14	Reserve	
15	Reserve	

Table 26 Channel Alarm information

All data 0: Alarm OFF, 1: Alarm ON

Bit	Address 30093		Address 30094		Address 30095		Address 30096	
0	Channel 1	Alarm No.1	Channel 5	Alarm No.1	Channel 9	Alarm No.1	Channel 13	Alarm No.1
1		Alarm No.2		Alarm No.2		Alarm No.2		Alarm No.2
2		Alarm No.3		Alarm No.3		Alarm No.3		Alarm No.3
3		Alarm No.4		Alarm No.4		Alarm No.4		Alarm No.4
4	Channel 2	Alarm No.1	Channel 6	Alarm No.1	Channel 10	Alarm No.1	Channel 14	Alarm No.1
5		Alarm No.2		Alarm No.2		Alarm No.2		Alarm No.2
6		Alarm No.3		Alarm No.3		Alarm No.3		Alarm No.3
7		Alarm No.4		Alarm No.4		Alarm No.4		Alarm No.4
8	Channel 3	Alarm No.1	Channel 7	Alarm No.1	Channel 11	Alarm No.1	Channel 15	Alarm No.1
9		Alarm No.2		Alarm No.2		Alarm No.2		Alarm No.2
10		Alarm No.3		Alarm No.3		Alarm No.3		Alarm No.3
11		Alarm No.4		Alarm No.4		Alarm No.4		Alarm No.4
12	Channel 4	Alarm No.1	Channel 8	Alarm No.1	Channel 12	Alarm No.1	Channel 16	Alarm No.1
13		Alarm No.2		Alarm No.2		Alarm No.2		Alarm No.2
14		Alarm No.3		Alarm No.3		Alarm No.3		Alarm No.3
15		Alarm No.4		Alarm No.4		Alarm No.4		Alarm No.4

Bit	Address 30097		Address 30098		Address 30099		Address 30100	
0	Channel 17	Alarm No.1	Channel 21	Alarm No.1	Channel 25	Alarm No.1	Channel 29	Alarm No.1
1		Alarm No.2		Alarm No.2		Alarm No.2		Alarm No.2
2		Alarm No.3		Alarm No.3		Alarm No.3		Alarm No.3
3		Alarm No.4		Alarm No.4		Alarm No.4		Alarm No.4
4	Channel 18	Alarm No.1	Channel 22	Alarm No.1	Channel 26	Alarm No.1	Channel 30	Alarm No.1
5		Alarm No.2		Alarm No.2		Alarm No.2		Alarm No.2
6		Alarm No.3		Alarm No.3		Alarm No.3		Alarm No.3
7		Alarm No.4		Alarm No.4		Alarm No.4		Alarm No.4
8	Channel 19	Alarm No.1	Channel 23	Alarm No.1	Channel 27	Alarm No.1	Reserve	
9		Alarm No.2		Alarm No.2		Alarm No.2	Reserve	
10		Alarm No.3		Alarm No.3		Alarm No.3	Reserve	
11		Alarm No.4		Alarm No.4		Alarm No.4	Reserve	
12	Channel 20	Alarm No.1	Channel 24	Alarm No.1	Channel 28	Alarm No.1	Reserve	
13		Alarm No.2		Alarm No.2		Alarm No.2	Reserve	
14		Alarm No.3		Alarm No.3		Alarm No.3	Reserve	
15		Alarm No.4		Alarm No.4		Alarm No.4	Reserve	

8. SAMPLE PROGRAM

This section concerns data read-out/write-in sample program by GW-BASIC*1 which operated on Windows 98*1 MS-DOS*1 PROMPT.

Note that the program shown here is for reference for you to create a program and not for guaranteeing all actions. Before executing the program, make sure of the communication conditions in the following procedure.

- Communication speed (baud rate), data length, stop bits and parity bit:
Set in this program. Match the conditions with this instrument.

*1: GW-BASIC, Windows 98 and MS-DOS are the registered trademarks of Microsoft Corporation.

(a) Example of data read-out

Operation : allows measured values in Channel 1 to 9 to be read out at a time.

(Continuous word read-out from read-out only area)

Used function code : 04H
Read-out start register No. : 30101
Read-out word number : 9

```
1000 '-----  
1010 ' READ CONTINUOUS WORDS SAMPLE PROGRAM  
1020 '-----  
1030 '  
1040 '  
1050 '  
1060 CLS  
1070 DIM CC(255)  
1080 '  
1100 '----- Send data setting -----  
1110 CC(1)=&H01 'Station No. = 1  
1120 CC(2)=&H04 'Function code = 04H  
1130 CC(3)=&H00 'Upper byte of relative address(0064H) of resister No.30101  
1140 CC(4)=&H64 'Lower byte of relative address(0064H) of resister No.30101  
1150 CC(5)=&H00 'Upper byte of read-out word number(0009H)  
1160 CC(6)=&H09 'Lower byte of read-out word number(0009H)  
1170 COUNT=6  
1200 '  
1210 '----- CRC code calculation of send data -----  
1220 GOSUB 3020  
1230 CC(7)=CRC.L 'Lower byte of CRC calculation result -> Upper byte in message  
1240 CC(8)=CRC.H 'Upper byte of CRC calculation result -> Lower byte in message  
1250 COUNT=COUNT+2  
1300 '  
1310 '----- Send data -----  
1320 PRINT "Sending data > ";  
1330 OPEN "COM1:9600,0,8,1" AS #1 '9600bps, Odd parity, Data Length=8, Stop bit=1  
1340 FOR I=1 TO COUNT  
1350 PRINT #1,CHR$(CC(I)); 'Writing in transmission port  
1360 PRINT RIGHT$("0"+HEX$(CC(I)),2);" "; 'Displaying on screen  
1370 NEXT I  
1380 '  
1390 FOR I=0 TO 300000 :NEXT I 'Interval time  
1500 '  
1510 '----- Data receive -----  
1520 PRINT  
1530 LENGTH=LOC(1) 'Number of data in receiving buffer  
1540 IF LENGTH=0 THEN PRINT "No answer" :END  
1550 PRINT "Receiving data < ";  
1560 FOR I=1 TO LENGTH  
1570 X$=INPUT$(1,#1) 'Taking data from receiving buffer  
1580 CC(I)=ASC(X$) 'Digitizing and storing  
1590 PRINT RIGHT$("0"+HEX$(CC(I)),2);" "; 'Displaying on screen  
1600 NEXT I  
1610 CLOSE #1  
1620 COUNT=LENGTH-2  
1630 GOSUB 3020 'GOSUB *CRC.CALC  
1700 '  
1710 '----- Transmission error check -----  
1720 PRINT  
1730 CRC.L$=RIGHT$("0"+HEX$(CRC.L),2)  
1740 CRC.H$=RIGHT$("0"+HEX$(CRC.H),2)  
1750 PRINT "CRC calculation = ";CRC.L$;" ";CRC.H$  
1760 IF CC(LENGTH-1)<>CRC.L THEN GOTO 1790 'GOTO *ER.MESSAGE  
1770 IF CC(LENGTH)<>CRC.H THEN GOTO 1790 'GOTO *ER.MESSAGE  
1780 GOTO 1920 'GOTO *PRT.RESULT  
1790 '*ER.MESSAGE  
1800 PRINT "Communication error"  
1810 END  
1900 '  
1910 '----- Display of result -----  
1920 '*PRT.RESULT  
1930 ' In case of decimal point position = 1 and unit = mV  
1940 PRINT
```

```

1950 CH1$=HEX$(CC(4))+RIGHT$("0"+HEX$(CC(5)),2) '2byte -> lword
1960 CH2$=HEX$(CC(6))+RIGHT$("0"+HEX$(CC(7)),2) '2byte -> lword
1970 CH3$=HEX$(CC(8))+RIGHT$("0"+HEX$(CC(9)),2) '2byte -> lword
1980 CH4$=HEX$(CC(10))+RIGHT$("0"+HEX$(CC(11)),2) '2byte -> lword
1990 CH5$=HEX$(CC(12))+RIGHT$("0"+HEX$(CC(13)),2) '2byte -> lword
2000 CH6$=HEX$(CC(14))+RIGHT$("0"+HEX$(CC(15)),2) '2byte -> lword
2010 CH7$=HEX$(CC(16))+RIGHT$("0"+HEX$(CC(17)),2) '2byte -> lword
2020 CH8$=HEX$(CC(18))+RIGHT$("0"+HEX$(CC(19)),2) '2byte -> lword
2030 CH9$=HEX$(CC(20))+RIGHT$("0"+HEX$(CC(21)),2) '2byte -> lword
2040 PRINT "CH1 =";VAL("&H"+CH1$)/10;"mV" '1 place of decimal
2050 PRINT "CH2 =";VAL("&H"+CH2$)/10;"mV" '1 place of decimal
2060 PRINT "CH3 =";VAL("&H"+CH3$)/10;"mV" '1 place of decimal
2070 PRINT "CH4 =";VAL("&H"+CH4$)/10;"mV" '1 place of decimal
2080 PRINT "CH5 =";VAL("&H"+CH5$)/10;"mV" '1 place of decimal
2090 PRINT "CH6 =";VAL("&H"+CH6$)/10;"mV" '1 place of decimal
2100 PRINT "CH7 =";VAL("&H"+CH7$)/10;"mV" '1 place of decimal
2110 PRINT "CH8 =";VAL("&H"+CH8$)/10;"mV" '1 place of decimal
2120 PRINT "CH9 =";VAL("&H"+CH9$)/10;"mV" '1 place of decimal
2130 END
3000 '
3010 '----- CRC calculation -----
3020 '*CRC.CALC 'For contents, refer to CRC calculation flow chart
3030 CR=&HFFFF
3040 FOR I=1 TO COUNT
3050 CR=CR XOR CC(I)
3060 FOR J=1 TO 8
3070 CT=CR AND &H1
3080 IF CR<0 THEN CH=1 ELSE CH=0:GOTO 3100
3090 CR=CR AND &H7FFF
3100 '*CRC.CALC.10
3110 CR=INT(CR/2)
3120 IF CH=1 THEN CR=CR OR &H4000
3130 IF CT=1 THEN CR=CR XOR &HA001
3140 NEXT J
3150 NEXT I
3160 CRC.L=CR AND &HFF 'Lower byte of CRC calculation
3170 CRC.H=(CR AND &HFF00)/256 AND &HFF 'Upper byte of CRC calculation
3180 RETURN

```

(b) Data write-in example

Operation : allows alarm latch in Station No. 1 to be released via communication.

(Word write-in)

Used function code : 10H
Write-in start register No. : 45007
Write-in word number : 1
Write-in data : 1 (Alarm latch clear)

```
1000 '-----
1010 '  WRITE CONTINUOUS WORDS   SAMPLE PROGRAM
1020 '-----
1030 '
1040 '
1050 '
1060 CLS
1070 DIM CC(255)
1080 '
1100 '----- Send data setting -----
1110 CC(1)=&H01      'Station No. = 1
1120 CC(2)=&H10      'Function code = 10H
1130 CC(3)=&H13      'Upper byte of relative address(138EH) of resister No.45007
1140 CC(4)=&H8E      'Lower byte of relative address(138EH) of resister No.45007
1150 CC(5)=&H00      'Upper byte of write-in word number(0001H)
1160 CC(6)=&H01      'Lower byte of write-in word number(0001H)
1170 CC(7)=&H02      'Write-in word number * 2
1180 CC(8)=&H00      'Upper byte of write-in data(0001H)
1190 CC(9)=&H01      'Lower byte of write-in data(0001H)
1200 COUNT=9
1210 '----- CRC code calculation of send data -----
1220 GOSUB 3020
1230 CC(10)=CRC.L    'Lower byte of CRC calculation result -> Upper byte in
message
1240 CC(11)=CRC.H    'Upper byte of CRC calculation result -> Lower byte in
message
1250 COUNT=COUNT+2
1300 '
1310 '----- Send data -----
1320 PRINT "Sending data > ";
1330 OPEN "COM1:9600,o,8,1" AS #1 '9600bps, Odd parity, Data Length=8, Stop bit=1
1340 FOR I=1 TO COUNT
1350   PRINT #1,CHR$(CC(I));           'Writing in transmission port
1360   PRINT RIGHT$("0"+HEX$(CC(I)),2);" "; 'Displaying on screen
1370 NEXT I
1380 '
1390 FOR I=0 TO 300000 :NEXT I          'Interval time
1500 '
1510 '----- Data receive -----
1520 PRINT
1530 LENGTH=LOC(1)                      'Number of data in receiving buffer
1540 IF LENGTH=0 THEN PRINT "No answer" :END
1550 PRINT "Receiving data < ";
1560 FOR I=1 TO LENGTH
1570   X$=INPUT$(1,#1)                   'Taking data from receiving buffer
1580   CC(I)=ASC(X$)                     'Digitizing and storing
1590   PRINT RIGHT$("0"+HEX$(CC(I)),2);" "; 'Displaying on screen
1600 NEXT I
1610 CLOSE #1
1620 COUNT=LENGTH-2
1630 GOSUB 3020                          'GOSUB *CRC.CALC
1700 '
1710 '----- Transmission error check -----
1720 PRINT
1730 CRC.L$=RIGHT$("0"+HEX$(CRC.L),2)
1740 CRC.H$=RIGHT$("0"+HEX$(CRC.H),2)
1750 PRINT "CRC calculation = ";CRC.L$;" ";CRC.H$
1760 IF CC(LENGTH-1)<>CRC.L THEN GOTO 1790 'GOTO *ER.MESSAGE
1770 IF CC(LENGTH)<>CRC.H THEN GOTO 1790 'GOTO *ER.MESSAGE
1780 GOTO 1920                            'GOTO *PRT.RESULT
1790 '*ER.MESSAGE
1800 PRINT "Communication error"
1810 END
```

```

1900 '
1910 '----- Display of result -----
1920 '*PRT.RESULT
1930 PRINT
1940 PRINT "Completion of alarm latch clear"
1950 END
3000 '
3010 '----- CRC calculation -----
3020 '*CRC.CALC          'For contents, refer to CRC calculation flow chart
3030 CR=&HFFFF
3040 FOR I=1 TO COUNT
3050 CR=CR XOR CC(I)
3060 FOR J=1 TO 8
3070 CT=CR AND &H1
3080 IF CR<0 THEN CH=1 ELSE CH=0:GOTO 3100
3090 CR=CR AND &H7FFF
3100 '*CRC.CALC.10
3110 CR=INT(CR/2)
3120 IF CH=1 THEN CR=CR OR &H4000
3130 IF CT=1 THEN CR=CR XOR &HA001
3140 NEXT J
3150 NEXT I
3160 CRC.L=CR AND &HFF
3170 CRC.H=((CR AND &HFF00)/256 AND &HFF)
3180 RETURN

```

```

'Lower byte of CRC calculation
'Upper byte of CRC calculation

```

9. ETHERNET COMMUNICATION FUNCTIONS

FTP server function, web server function, E-mail send function and MODBUS TCP/IP function can be used for Ethernet communication.

Setting of IP address, etc. is essential for connection of a paperless recorder to Ethernet. Be sure to consult with the system manager of your company.

9.1 LAN port specification

Item	Specification
Transmission rate	10 Mbps
Transmission method	Base band
Maximum network length or maximum node interval	500 m (cascade in 4 stages)
Maximum segment length	100 m (between node and hub)
Cable for connection	UTP (twisted-pair cable without shield) 22-26 AWG
Protocol	TCP/IP

9.2 Connection to the terminal

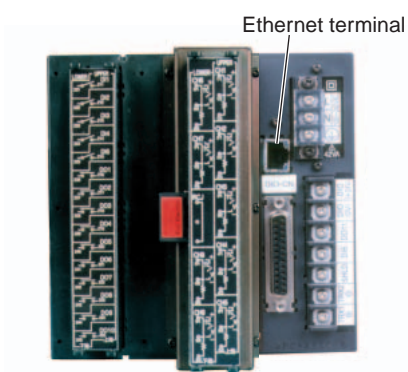

9.3 Connection

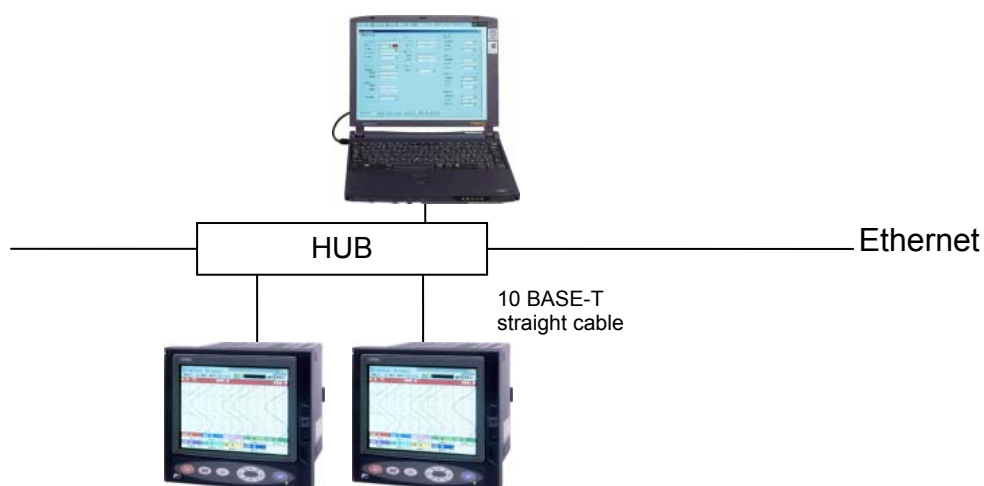

Node to hub distance:	Up to 100 m
Maximum number of nodes per network:	100 nodes
Recommended cable:	10 BASE-T twisted-pair cable, Category 5

9.4 Setting Ethernet communicating conditions

- Set IP address, subnet mask and default gateway for connection of the paperless recorder to Ethernet. (Consult with the system manager of your company for the values to be set.)

- Communicating conditions setting items

Item	Value at delivery	Setting range	Remarks
IP address	192.168. 1. 1	0 to 255 for each digit	Turn ON the power again after setting change.
Subnet mask	255.255.255. 0	0 to 255 for each digit	
Default gateway	0. 0. 0. 0	0 to 255 for each digit	

9.5 Ethernet communicating conditions setting operation

- (1) Select "Main unit" → "Ethernet communication setting" on the parameter setting screen, and the "Ethernet communication setting" screen appears.

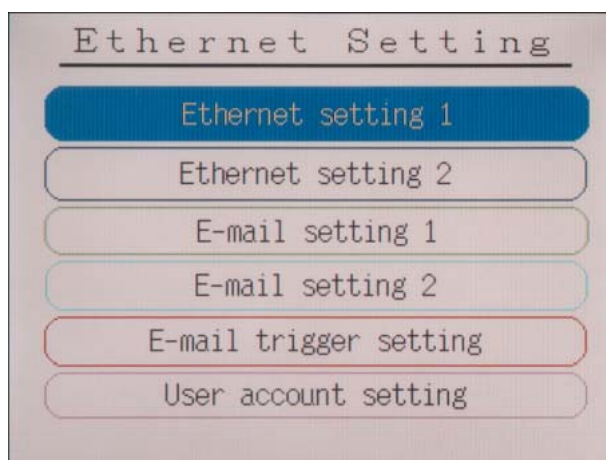

- (2) Select "Ethernet setting 1", and the following screen appears.

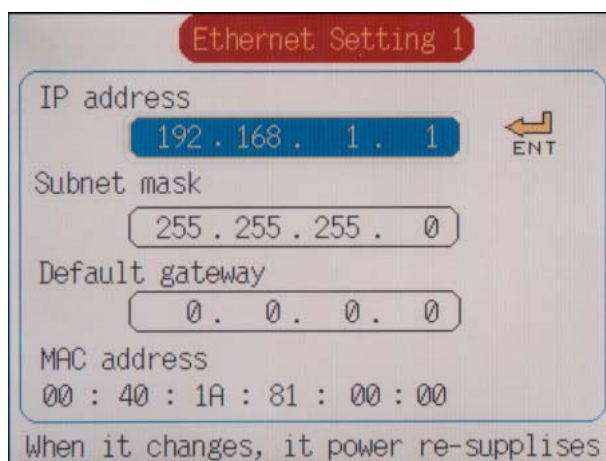

- (3) Move the cursor to "IP address" and set an IP address.
- (4) Move the cursor to "Subnet mask", and set a subnet mask.
- (5) Move the cursor to "Default gateway", and set a default gateway.

10. FTP SERVER FUNCTION

10.1 Description of FTP server function

- This function permits take-out of record files from the compact flash of the recorder, using browser or DOS prompt.
- This function permits take-out of record data from the internal memory of the recorder, using browser or DOS prompt.
- This function permits deletion of record files from the compact flash of the recorder, using browser or DOS prompt. (Users of Administrator, Engineer and Operator level can be deleted.)
- This function permits changing names of record files recorded on the compact flash of the recorder, using browser or DOS prompt. (Users of Administrator, Engineer and Operator level can be changed.)
- Use Internet Explorer made by Microsoft as the personal computer's browser.
- Up to eight (8) user names and passwords may be set for those who are permitted to log in the FTP server.
- If the FTP server access verify function is OFF, log-in to the FTP server is permitted with common user name “ftp” (without password).
- When log-in or log-off to/from the FTP server is executed, the subject information is displayed on the Ethernet communication log screen.
- The FTP server permits log-in by one user only at a time.
- Record data in the internal memory of recorder becomes binary format regardless of “Record data format” setting in the main body.
- The folder configuration of FTP server is shown in the next page.

[Caution]

- The communication automatically disconnects, if no FTP communication request is made for 10 minutes.
- The display motion of the paperless recorder may slow down when taking out a file of large size.
- While the compact flash of the paperless recorder is accessed by FTP communication, do not take out the compact flash.
Furthermore, when the FTP server function is used, inhibit access to the compact flash in the “Memory card abstract” screen, before taking out the compact flash.
- Do not delete or change the name of a file while the file is being recorded or integrated.
- Attributes of all files in the FTP server are displayed as read-only as hidden files.
- If the Ethernet communication is shut down while the FTP server is in log-in status, log-in is not permitted until the communication is automatically disconnected ten (10) minutes later.

FTP server folder configuration

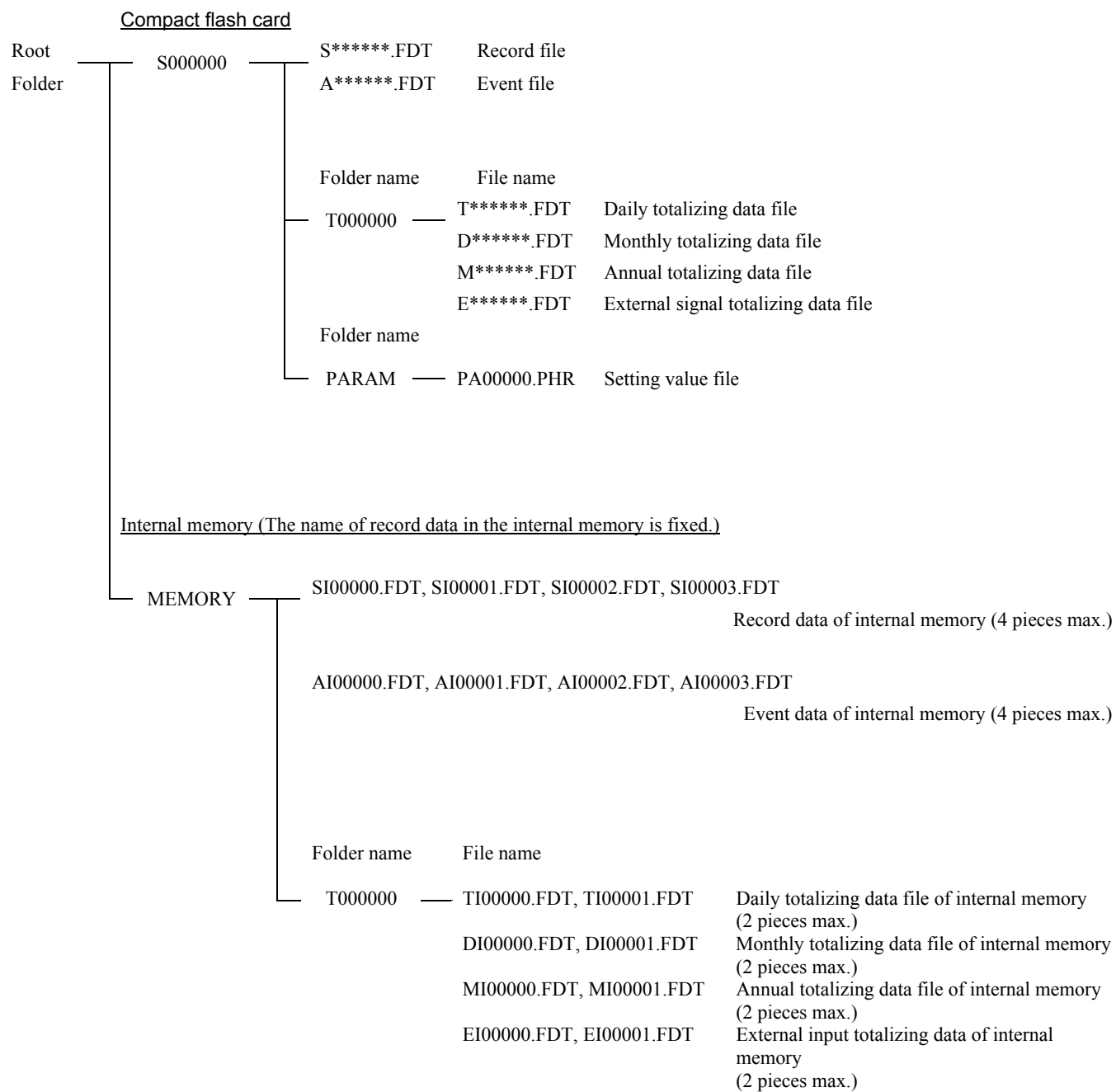

10.2 Setting FTP server function

- Execute setting of FTP server function and of access verification, for using the FTP server function. Furthermore, set names and passwords of those who use the FTP server function.

- FTP server function setting items

Item	Value at delivery	Setting range	Remarks
FTP server function	OFF	ON, OFF	Turn ON the power again after setting is changed.
FTP access control	OFF	ON, OFF	

- User name setting items

Item	Value at delivery	Setting range	Remarks
User 1 to 8 name	(Blank)	Up to 16 letters may be set.	
User 1 to 8 password	(Blank)	Up to 8 letters may be set.	
User 1 to 8 level	Administrator	Administrator, guest	

10.3 FTP server function setting operation

- FTP server function setting**

- Select “Main unit” → “Ethernet communication setting” → “Ethernet setting 2” on the parameter setting screen, and the following screen appears.

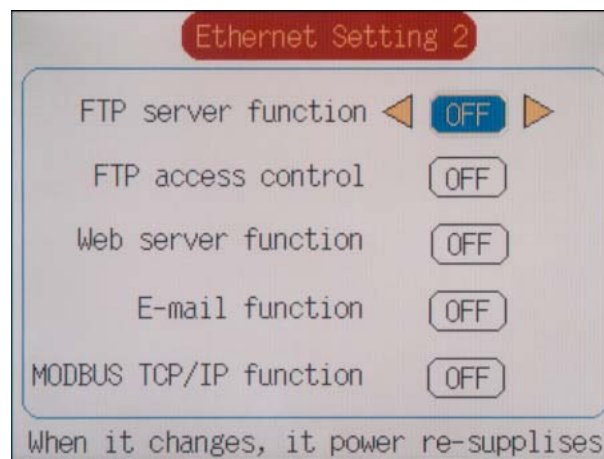

- Move the cursor to “FTP server function”, and select FTP server function ON/OFF. The FTP server function can be used, if ON is set.
- Move the cursor to “FTP access control”, and select FTP access control function ON/OFF. No password is required at the time of log-in to the FTP server, if OFF is set.

- **User name setting**

- (1) Select “Main unit” → “Ethernet communication setting” → “User account setting” on the parameter setting screen, and the following screen appears.



- (2) Select a user No. to be set.
- (3) Set a user name using up to 16 letters.
- (4) Set a password using up to 8 letters.
- (5) Select a user access level out of “administrator” and “guest”.
If “guest” was selected, file deletion is not permitted, although log-in to the FTP server is permitted.

10.4 FTP server operation

- Connect the FTP server to the paperless recorder from the browser, by performing operation in the sequence indicated below.
 - (1) Start Internet Explorer from a personal computer on Ethernet.
 - (2) Enter the IP address of the paperless recorder in the address column in the following manner.
FTP: //(paperless recorder's IP address)
Enter FTP: //192.168.1.2 in case the IP address of the paperless recorder is 192.168.1.2.
 - (3) The screen that requests entry of user name and password appears. Enter a user name and password.
 - (4) The “S000000” and “MEMORY” directories are displayed on the browser.
Select the “S000000” folder to display the recorded files in the compact flash.
Select the “MEMORY” folder to display the recorded data in the internal memory.
 - (5) The files recorded in the browser are displayed.
 - (6) Select a desired file and copy it to an arbitrary folder in the personal computer.
 - (7) If the compact flash was selected, you can delete the recorded files. Select a desired file and delete it.

11. Web server function

11.1 Description of web server function

- The web server function permits monitoring of measured values and event log in the paperless recorder using personal computer's browser.
- Use Internet Explorer made by Microsoft as the personal computer's browser.

[Caution] • Monitoring from cell phone's browser is not permitted. If connection to recorder's web server is made from a cell phone, the recorder may halt in the worst case. Do not attempt to monitor data in the paperless recorder from a cell phone.

- An error may arise depending on the circumstances of the communication, as the period of update of the browser is 10 seconds.

The screen of the PC is displayed again, if the update button of the browser is pressed in such a case.

- The characters may not be displayed normally depending on the setting of the browser.
- With the type of 9-channel specifications, 0.0°C is displayed as the reading of channels 10 to 18 on the measured value display screen.

11.2 Setting web server function

- Set the web server function for permitting its use.
- Set items

Item	Value at delivery	Setting range	Remarks
Web server function	OFF	ON, OFF	Turn ON the power again after setting is changed.

11.3 Web server function setting operation

- (1) Select “Main unit” → “Ethernet communication setting” → “Ethernet setting 2” on the parameter setting screen, and the follow screen appears.

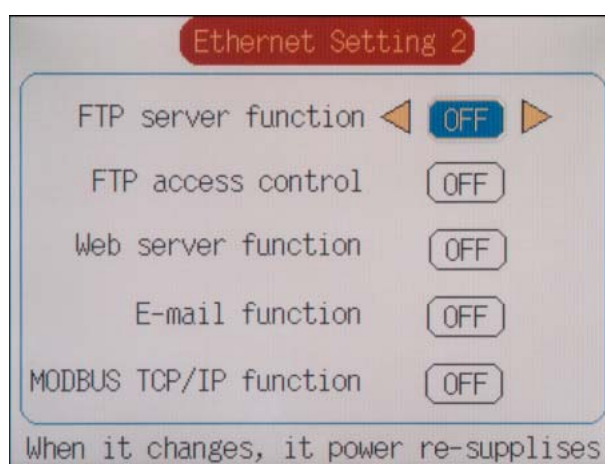

- (2) Move the cursor to “Web server function”, and select web server function ON/OFF. Use of the web server function is permitted if ON is set.

11.4 Web server operation

- Connect the web server to the paperless recorder from the personal computer's browser, by performing operation in the sequence indicated below.
 - (1) Start Internet Explorer from a personal computer on Ethernet.
 - (2) Enter the IP address of the paperless recorder in the address column in the following manner.
http: //(paperless recorder's IP address)
Enter http: //192.168.1.2 in case the IP address of the paperless recorder is 192.168.1.2.
 - (3) The paperless recorder monitor screen is displayed on the browser.

11.5 Web monitor screen

- Connect to the web server of the paperless recorder, and the following screen appears.
 - (1) **Web monitor menu screen**

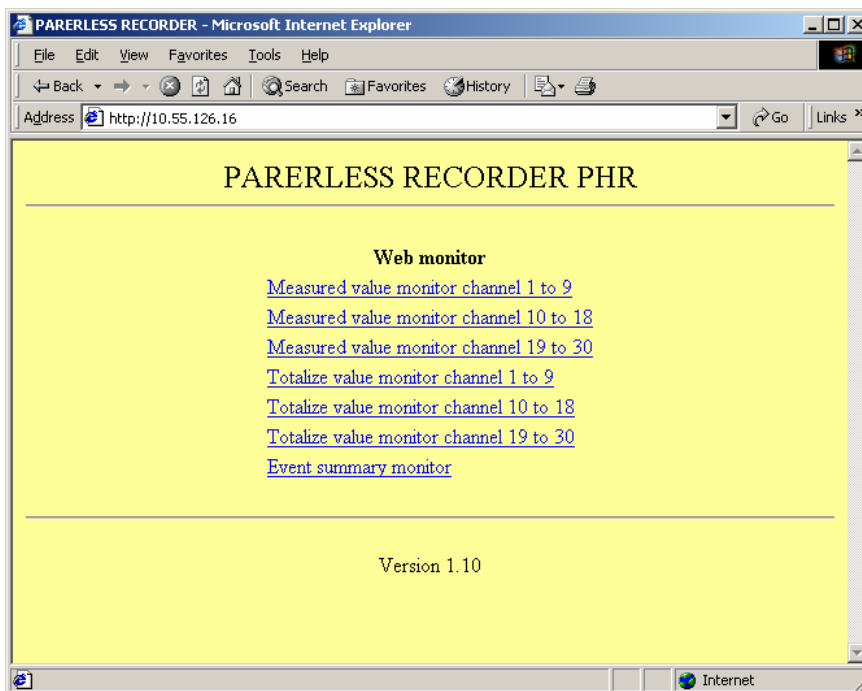

(2) PV display screen

PV display (channel 1 to 9)

DATE 2008/4/15 16:18:40 Record status Stop
 PILC PHR21B14-E10EY Totalize status Stop
 SNO. 0000 Data capacity 80%
 Main status None

CH	Tag	Value	Alarm 1234			
CH 1	Tag 01 Tag 2-01	261.7 m3/h	1	2	3	4
CH 2	Tag 02 Tag 2-02	261.7 mV	1	2	3	4
CH 3	Tag 03 Tag 2-03	1.93E+0 bar	1	2	3	4
CH 4	Tag 04 Tag 2-04	Over V	1	2	3	4
CH 5	Tag 05 Tag 2-05	0.0285 ms	1	2	3	4
CH 6	Tag 06 Tag 2-06	229.3 mV	1	2	3	4
CH 7	Tag 07 Tag 2-07	1.35E+1 Pa	1	2	3	4
CH 8	Tag 08 Tag 2-08	112.0 mV	1	2	3	4
CH 9	Tag 09 Tag 2-09	Over	1	2	3	4

(3) Totalize display screen

Totalize display (channel 1 to 9)

DATE 2008/4/3 20:58:43 Record status Stop
 PILC PHR21B14-N10EY Totalize status Totalizing
 SNO. 0000 Data capacity 90%
 Main status None

CH	STAG	Total	Start time	End time
CH 1	STAG 01	0.0	2008/4/3 20:00:00	2008/4/3 20:58:43
CH 2	STAG 02	0.00	2008/4/3 20:00:00	2008/4/3 20:58:43
CH 3	STAG 03	2592	2008/4/3 20:00:00	2008/4/3 20:58:43
CH 4	STAG 04	0.1066	2008/4/3 20:00:00	2008/4/3 20:58:43
CH 5	STAG 05	0.000	2008/4/3 20:00:00	2008/4/3 20:58:43
CH 6	STAG 06	0.000	2008/4/3 20:00:00	2008/4/3 20:58:43
CH 7	STAG 07	110.6	2008/4/3 20:00:00	2008/4/3 20:58:43
CH 8	STAG 08	109.5	2008/4/3 20:00:00	2008/4/3 20:58:43
CH 9	STAG 09	0.0	2008/4/3 20:00:00	2008/4/3 20:58:43

(4) Event Summary display screen

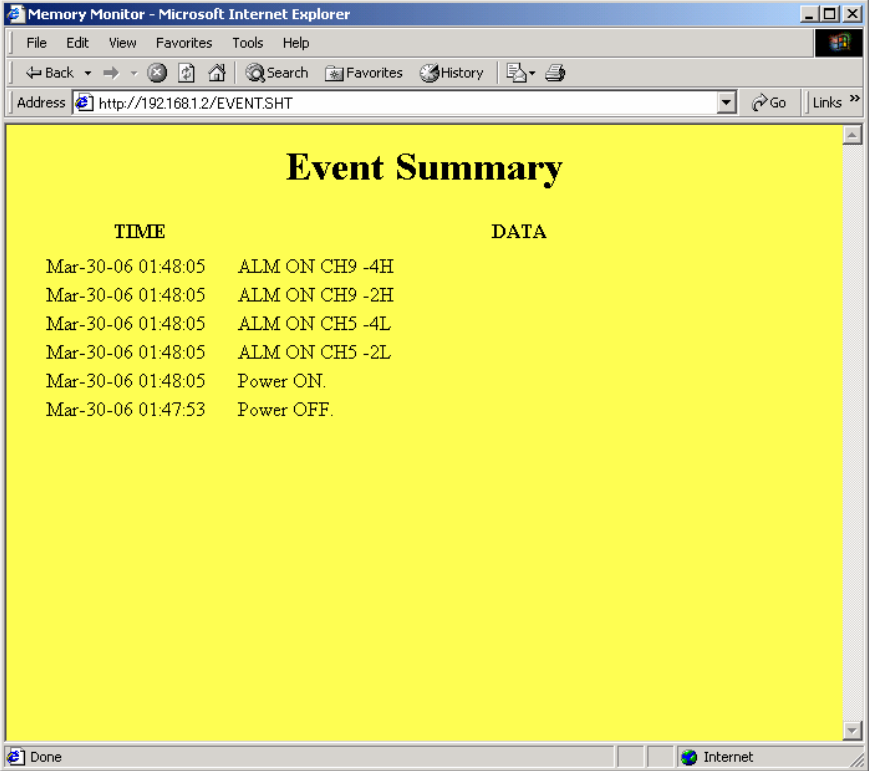

12. E-MAIL SEND FUNCTION

12.1 Description of E-mail send function

- E-mails can be transmitted from the paperless recorder. (Receipt of E-mails is not permitted.)
- E-mails can be transmitted in any of the states indicated below.
 - (1) An alarm arose or was cancelled.
 - (2) An external input (DI) was ON or OFF.
 - (3) Any error occurred to the main unit. (When battery end, memory card full, or one of the alarms of all the channels should occur)
 - (4) Once every fixed period (The period may be selected out of 1 hour, 2 hours, 3 hours, 4 hours, 6 hours, 12 hours and 24 hours.)
- Up to eight (8) addresses can be registered for transmission of E-mails.
- Measured values of each channel can be attached to each E-mail.
- E-mail transmission test can be conducted in the E-mail trigger setting screen.

[Caution]

- Up to sixteen (16) E-mail send requests can be transmitted continuously, but not more than 16. No transmission will be implemented if the number of E-mail send requests exceeds 16. Therefore, make setting so that E-mail send requests will not occur continuously.
- For sending E-mails, it is necessary to register the paperless recorder in the mail server. Consult with the system manager of your company, for registration to the mail server.
- If E-mail send fails, the E-mail send requests are cancelled.
- Even if E-mail is sent, there is a possibility where the E-mail does not reach the destination because of incorrect address, etc.
- If two or more E-mail addresses are set as send destinations in the E-mail trigger setting, the error message is not recorded on the Ethernet log screen unless all the attempts to send E-mails fail.

12.2 Setting E-mail function

- Set E-mail send/receive addresses and E-mail send trigger, for permitting use of the E-mail function. (Consult with the system manager of your company, for the values to be set.)

- E-mail function set items

Item	Value at delivery	Setting range	Remarks
E-mail function	OFF	ON, OFF	Turn ON the power again after setting change.

- E-mail send/receive address set items

Item	Value at delivery	Setting range	Remarks
SMTP IP address	0. 0. 0. 0	0 to 255 for each digit	
Sender's mail address	(Blank)	Up to 64 letters may be set.	
Sender's mail name	(Blank)	Up to 32 letters may be set.	
Receiver's mail address 1 to 8	(Blank)	Up to 64 letters may be set.	

- E-mail send trigger set items

Item	Value at delivery	Setting range	Remarks
Title	(Blank)	Up to 32 letters may be set.	
Trigger timing	None	None, DI ON, DI OFF, Alarm ON, Alarm OFF, Warning, Timer cycle	
DI No.	DI 1	DI 1 to 10	Trigger timing = DI ON, DI OFF
Alarm Channel	Channel 1	Channel 1 to 18	Trigger timing = Alarm ON, OFF
Alarm No.	1	1 to 4	
Warning type	Alarm ON (All ch)	Alarm ON (All ch), All warning, No battery, CF full	Trigger timing = Warning
Time cycle	1 hour	1, 2, 3, 4, 6, 12 hour, 1 day	Trigger timing = Timer cycle
Time base (hour)	0:00	0:00 to 23:00	
Text 1	(Blank)	Up to 32 letters may be set.	
Text 2	(Blank)	Up to 32 letters may be set.	
PV value affixation	OFF	ON, OFF	
Receiver's add No.	None	Receiver's address No. 1, 2, 3, 4, 5, 6, 7, 8	

12.3 E-mail function setting operation

- Setting E-mail function**

(1) Select “Main unit” → “Ethernet communication setting” → “Ethernet setting 2” on the parameter setting screen, and the following screen appears.

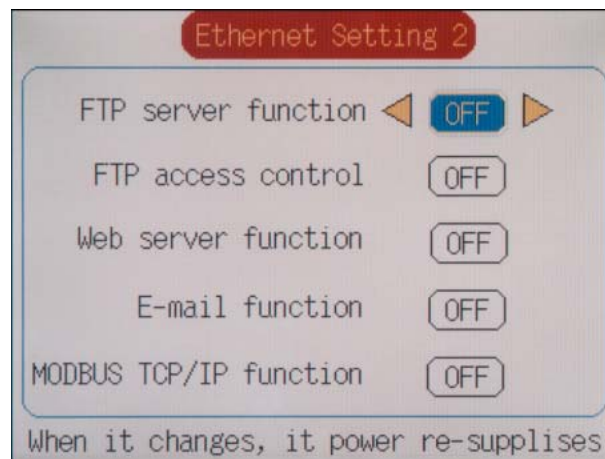

(2) Move the cursor to “E-mail function”, and select E-mail function ON/OFF. The E-mail send function can be used, if ON is set.

- **Setting E-mail send/receive addresses**

- (1) Select “Main unit” → “Ethernet communication setting” → “E-mail setting 1” on the parameter setting screen, and the following screen appears.

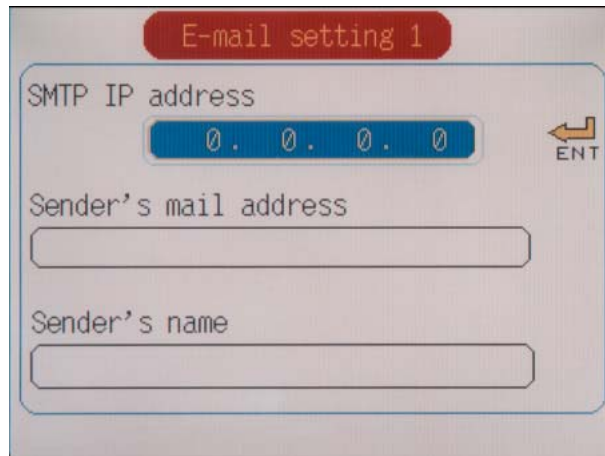

- (2) Move the cursor to “SMTP IP address”, and set the IP address of the mail server.
- (3) Move the cursor to “Sender’s mail Add”, and set the sender's mail address.
- (4) Move the cursor to “Sender’s mail Name”, and set the sender's name.
- (5) Select “Main unit” → “Ethernet communication setting” → “E-mail setting 2” on the parameter setting screen, and the following screen appears.

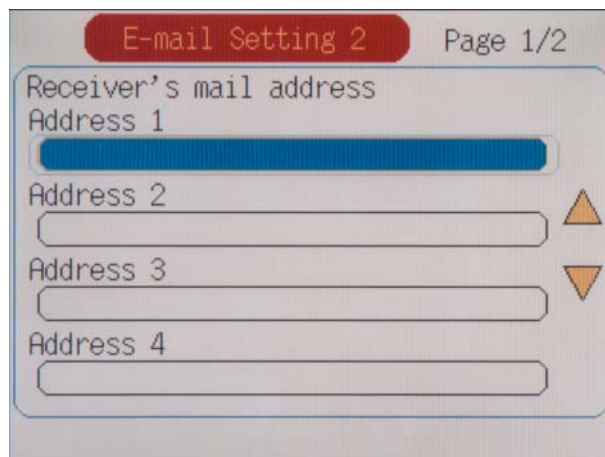

- (6) Move the cursor to “Receiver’s mail Add”, and set up to eight (8) receivers' mail addresses.

- **Setting E-mail send trigger**

(1) Select “Main unit” → “Ethernet communication setting” → “E-mail trigger setting” on the parameter setting screen, and the following screen appears.

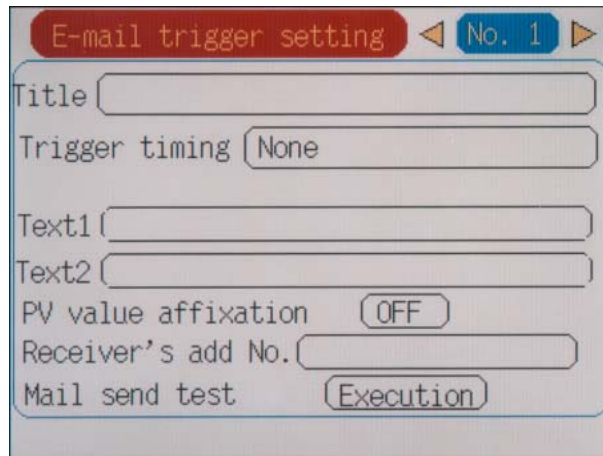

(2) Up to ten (10) patterns of E-mail send timing may be set.

Select a send timing to be selected, and press the [ENT] key.

(3) Move the cursor to “Title”, and set the E-mail title.

(4) Move the cursor to “Trigger timing”, and select an E-mail send timing.

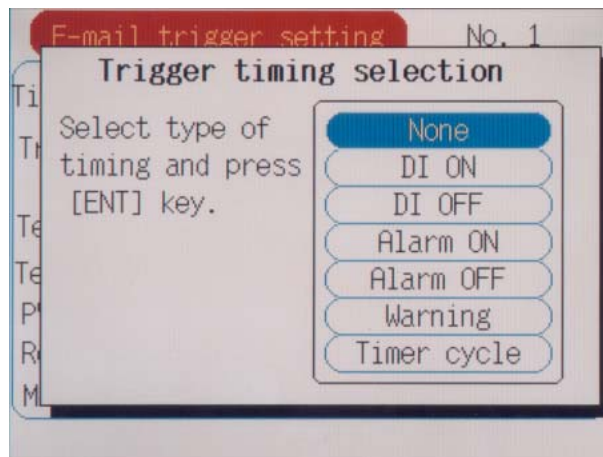

Select one of the followings as an E-mail send timing.

When a timing is selected, particulars set items are displayed for each timing type. Set these items also.

1) DI ON, DI OFF

E-mails can be sent by DI ON/OFF.

When DI ON/OFF timing is selected, set items for the DI No. to be used are displayed. Set the DI No. to be used for judgment.

2) Alarm ON, Alarm OFF

E-mails can be sent by the alarm occur/cancel information.

When alarm ON/OFF timing is selected, set items for the channel No. and alarm No. to be used are displayed. Set the channel No. and alarm No. to be used for judgment.

3) Warning

E-mails can be sent by warning occur information.

When warning is selected, set items for the warning information to be used are displayed. Set the warning information to be used for judgment.

4) Timer cycle

E-mails can be sent in a fixed period.

When timer cycle is selected, set items for the send period and reference time are displayed. Set the E-mail send period and reference time.

(5) Move the cursor to “Text 1”, “Text 2”, and set a comment of two (2) lines to be described in the E-mail.

(6) Move the cursor to “PV value affixation”, and set whether to indicate measured values of all the channels in the E-mail. All the channels can be indicated, ON is set.

(7) Move the cursor to “Receiver’s add No.”, and select an address No. to receive the E-mail.

The E-mail is sent to each address No. for which ON was set.

12.4 E-mail send test operation

- Conduct an E-mail send test with the paperless recorder, by performing operation in the sequence indicated below.

(1) Select “Main unit” → “Ethernet communication setting” → “E-mail trigger setting”.

(2) Select an E-mail trigger setting No. to conduct a send test.

(3) Move the cursor to “Mail send test”, and press the [ENT] key. Then, an E-mail send test can be conducted.

12.5 E-mail send contents

- The paperless recorder sends an E-mail with following contents.

From: LY-E04	←	Sender's mail name
Date: Wednesday, April 03, 2002 8:00 PM		
To: m-test2 ; m-test8		
Subject: Timer cycle	←	Mail title

2002/ 4/ 3 20:00:00 Operational report ← Mail trigger timing & time

1hour ← Mail text 1

PVON ← Mail text 2

CH1 = 862.6mH ← PV value

CH2 = 862.5mm/s

CH3 = 862.5mV

CH4 = 862.5mV

CH5 = 6.270V

CH6 = 6.270V

CH7 = 6.270V

CH8 = 6.270V

CH9 = 6.270V

13. MODBUS TCP/IP FUNCTION

13.1 Description of MODBUS TCP/IP function

- The MODBUS TCP/IP protocol permits use of MODBUS protocol (MODBUS RTU), which is used with RS-485 interface, on an Ethernet interface.
* See Chapter 5 through Chapter 7 for MODBUS protocol (MODBUS RTU) of RS-485 interface.
- MODBUS TCP/IP communication is executed through port 502.
- The MODBUS TCP/IP function permits read/write of set values from/to the paperless recorder.

13.2 Setting MODBUS TCP/IP function

- Make MODBUS TCP/IP function setting to permit the use of MODBUS TCP/IP function.
- Specify station No. to evaluate the device with which communication is to be carried out.
- Set items

Item	Factory default	Setting range	Remarks
MODBUS TCP/IP	OFF	ON, OFF	Turn on the power after the setting is changed.
MODBUS Station NO.	1	0 to 255	Communication is not carried out if 0 is selected.

13.3 MODBUS TCP/IP function setting operation

- (1) Select Select “Main unit” → “Ethernet communication setting” → “Ethernet setting 2” on the parameter setting screen, and the following screen appears.

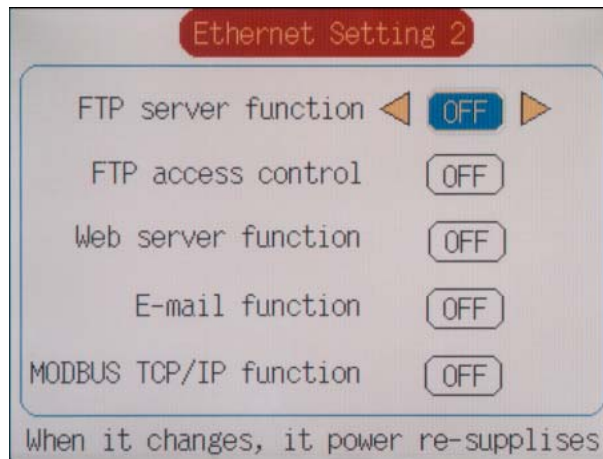

- (2) Move the cursor to “MODBUS TCP/IP”, and select MODBUS TCP/IP function ON/OFF. The MODBUS TCP/IP function can be used, if ON is set.
- (3) Select “Main unit” → “RS485 communication setting” on the parameter setting screen.
- (4) Move the cursor to “MODBUS Station No.” and select a desired station No.

13.4 MODBUS TCP/IP communication protocol

- The MODBUS TCP/IP communication protocol permits use of MODBUS protocol, which is used with RS-485 interface, on the same interface.
* See Chapter 5 through Chapter 7 for MODBUS protocol (MODBUS RTU) of RS-485 interface.
- MODBUS TCP/IP communication is executed through port 502.
- A message used by the MODBUS TCP/IP communication protocol is what is produced by deleting two bytes of error check code MODBUS TCP/IP from a message used by MODBUS RTU and by adding a 6-byte header. A MODBUS RTU message can be converted to a message for MODBUS TCP/IP as indicated below.

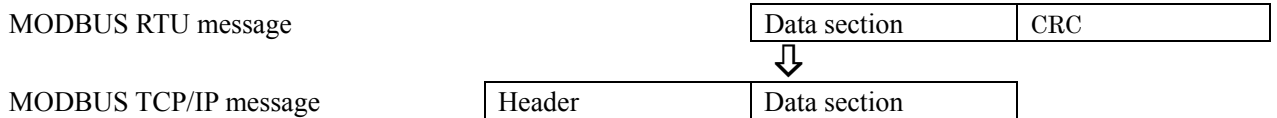

- The header of a MODBUS TCP/IP message is composed of transfer ID, protocol ID and total number of bytes of the data section.

Byte No.	0	1	2	3	4	5
Data content	Transaction Identifier		Protocol Identifier		Length Unit Identifier	

Data meaning:

Transaction Identifier: Identification of a MODBUS Request/Response transaction.

Protocol Identifier: Set 0 for MODBUS TCP/IP.

Length Unit Identifier: Number of bytes of data part

- Conversion of what is shown in Chapter 6.2 (3) Message transmission (example) into a MODBUS TCP/IP message, for instance, can be accomplished as described below.

For reading the measured value of channel 2 from station No. 1:

Relative address of channel 2 measured value: 0065H (register No. 30102), number of data: 01H

Composition of command message (bytes)

MODBUS RTU message (bytes)

Data section	Station No.	01H	
	Function code	04H	
	Read start No. (relative address)	More significant	00H
		Less significant	65H
	Number of read data	More significant	00H
Less significant		01H	
CRC	CRC data	More significant	21H
		Less significant	D5H

MODBUS TCP/IP message (bytes)

Header	Transfer ID	More significant	00H
		Less significant	00H
	Protocol ID	More significant	00H
		Less significant	00H
	Number of bytes	More significant	00H
		Less significant	06H
Data section	Station No.		01H
	Function code		04H
	Read start No. (relative address)	More significant	00H
		Less significant	65H
	Number of read data	More significant	00H
		Less significant	01H

Composition of response message (bytes)

MODBUS RTU message (bytes)

Data section	Station No.		01H
	Function code		04H
	Number of bytes of read data		02H
	Contents of first word data	More significant	01H
Less significant		4FH	
CRC	CRC data	More significant	F9H
		Less significant	54H

MODBUS TCP/IP message (bytes)

Header	Transfer ID	More significant	00H
		Less significant	00H
	Protocol ID	More significant	00H
		Less significant	00H
	Number of bytes	More significant	00H
		Less significant	05H
Data section	Station No.		01H
	Function code		04H
	Number of bytes of read data		02H
	Contents of first word data	More significant	01H
		Less significant	4FH

- The following error code is returned on occurrence of a communication error.

Error code	Content	Explanation
01H	Illegal function code	Non-actual function code is designated. Check for the function code.
02H	Illegal data address	A relative address of a register number to which the designated function code can not be used.
03H	Illegal data number	Because the designation of number is too much, the area where register numbers do not exist is designated.
04H	Device error	Communication with slave equipment failed. Check the communication specification for the slave equipment.

14. TROUBLESHOOTING

If the communication is unavailable, check the following items.

Case of RS-485 MODBUS communication

- Whether the power is turned ON again after communication setup change.
- Whether all devices related to communication are turned on.
- Whether connections are correct.
- Whether the number of connected instruments and connection distance are as specified.
- Whether communication conditions coincide between the master station (host computer) and slave stations (PHR).
 - Transmission speed : 9600bps
 19200bps
 - Data length : 8 bits
 - Stop bit : 1 bit
 - Parity : odd
 even
 none
- Whether send/receive signal timing conforms to Section 5.4 in this manual.
- Whether the station No. designated as send destination by the master station coincides with the station No. of the connected PHR.
- Whether more than one instrument connected on the same transmission line shares the same station No.
- Whether the station No. of instruments is set at other than 0.
If it is 0, the communication function does not work.
- Whether the 12th digit of type cord of this Recorder is R or W ?

(PHR □□□□□-□□□ $\begin{matrix} R \\ W \end{matrix}$ □-□)

Case of Ethernet communication (common to FTP, web, E-mail and MODBUS TCP/IP)

- Whether the power is turned ON again after communication setup change.
- Whether all devices related to communication are turned ON.
- Whether connections are correct.
- Whether the number of connected instruments and connection distance are as specified.
- Whether conditions for communication are correct.
 - IP address
 - Subnet mask
 - Default gateway
- Whether the 12th digit of type code of this Recorder is E or W?

(PHR □□□□□-□□□ $\begin{matrix} E \\ W \end{matrix}$ □-□)

Case of FTP server function

- Whether the user name, the password, and the user level are correct?
- Whether a compact flash has been inserted to the main unit.

Case of E-mail send function

- Whether conditions for communication are correct.
 - SMTP address
 - Sender's mail address
 - Receiver's mail address
- Whether E-mail send conditions are correct.

Case of MODBUS TCP/IP communication function

- Whether the station No. designated as send destination by the master station coincides with the station No. of this Recorder been connected.
- Whether the station No. of this Recorder is set other than 0.
If it is 0, the communication function does not work.

Fuji Electric Co., Ltd.

International Sales Div Sales Group

Gate City Ohsaki, East Tower, 11-2, Osaki 1-chome,
Shinagawa-ku, Tokyo 141-0032, Japan
<http://www.fujielectric.com>
Phone: 81-3-5435-7280, 7281 Fax: 81-3-5435-7425
<http://www.fujielectric.com/products/instruments/>
