

USER'S MANUAL
Rev. 01/2007

CD3000 *S*-2PH THYRISTOR UNIT

from 125A to 700A



CD Automation S.r.l.

Via Picasso 34/36 - 20025 - Legnano (MI) - ITALY

Tel +39 0331 577479 - Fax +39 0331 579479

E-Mail: info@cdautomation.com - WEB: www.cdautomation.com

SUMMARY

1 Important warnings for safety	5
2 Introduction	7
3 Quick Start	8
4 CD3000S Sizing	8
5 Identification and Order Code	9
5.1 Identification of the unit	9
5.2 Order Code	10
6 Installation	11
6.1 Environmental installation conditions	11
6.2 Dimensions and Weight	12
6.3 Fixing holes	13
7 Wiring instructions	14
7.1 Removing the cover	14
7.2 Wiring details	15
7.3 Power Terminals	17
7.4 Command Terminals	18
7.5 Diagram of control connection	19
8 Power output features	20
8.1 Derating curve	20
8.2 Cooling fans	20
9 Led status and Alarms	21
9.1 LED Status Table	21
10 Firing type	21
10.1 Zero Crossing (ZC)	21
11 Connection description	22
11.1 Access to the Electronic boards	22
11.2 Supply the Electronic Board	23
11.3 Input command	24
11.4 Digital Input	24

12 Internal Fuse	25
12.1 Fuse Code	25
13 Maintenance	26
13.1 Trouble Shooting	26
13.2 Fans	27
13.3 Maintenance	27
13.4 Repairing procedure	27
13.5 Warranty condition	27

1 Important warnings for safety

This chapter contains important information for the safety. The not observance of these instructions may result in serious personal injury or death and can cause serious damages to the Thyristor unit and to the components system included.

The installation should be performed by qualified persons.



The Thyristor unit are integral part of industrial equipments. When it is supply, the Thyristor unit is subject to dangerous tensions.

- Don't remove the protection Cover.
- Don't use these unit in aerospace applications and/ or nuclear.



The nominal current corresponds to use at temperature not superior to 45°C.

- The Thyristor unit must be mounted in vertical position and without obstruction above and below to allow a good flow ventilation.
- The hot air of one thyristor unit must not invest the unit positioned above.
- For side by side placed leave a space of 15mm between the unit.



A suitable device must ensure that the unit can be electrically isolated from the supply, this allows the qualified people to work in safety.



Protection (Protection, Protezione)

The unit have IP20 protection rating as defined by the specific international. Is necessary consider the place of installation.



Earth (Terre, Messa a terra)

For safety, the Thyristor unit with isolated heat-sink must be connected to earth. Earth impedance should be correspondent to local earth regulation. Periodically the earth efficiency should be inspected.



Electronic supply (Alimentation électronique, Alimentazione elettronica)

The electronic circuit of the Thyristor unit must be supplied by dedicated voltage for all electronic circuits and not in parallel with coil contactors, solenoids and other.

It's recommended to use a shielded transformer.



Electric Shock Hazard (Risque de choque électrique, Rischi di scosse elettriche)

When the Thyristor unit is energized, after the power supply is shut off, wait least a minute for allow the discharge of the internal capacitors where there is a dangerous tension. Before working, make sure that:

- Only authorized personnel must perform maintenance, inspection, and replacement operations.
- The authorized personnel must read this manual before to have access to the unit.
- Unqualified People don't perform jobs on the same unit or in the immediate vicinities.

**Important warnings (Attention, Avvertenze importanti)**

During the operations with units under tension, local regulations regarding electrical installation should be rigidly observed:

- Respect the internal safety rules.
- Don't bend components to maintain insulation distances.
- Protect the units from high temperature humidity and vibrations.
- Don't touch components to prevent electrostatic discharges on them.
- Verify that the size is in line with real needs.
- To measure voltage current etc. on unit, remove rings and other jewels from fingers and hands.
- Authorized personnel that work on thyristor unit under power supply voltage must be on insulated board

This listing does not represent a complete enumeration of all necessary safety cautions.

**Electromagnetic compatibility****(Compatibilità elettromagnétique, Compatibilità elettromagnetica)**

Our thyristor units have an excellent immunity to electromagnetic interferences if all suggestions contained in this manual are respected. In respect to a good Engineering practice, all inductive loads like solenoids contactor coils should have a filter in parallel.

**Emissions (Emission, Emissioni)**

All solid-state power controllers emit a certain amount of radio-frequency energy because of the fast switching of the power devices.

The CD Automation's Thyristor unit are in accord with the EMC norms, CE mark.

In most installations, near by electronic systems will experience no difficulty with interference. If very sensitive electronic measuring equipment or low-frequency radio receivers are to be used near the unit, some special precautions may be required. These may include the installation of a line supply filter and the use of screened (shielded) output cable to the load.

Note

Warning: This icon is present in all the operational procedures where the Improper operation may result in serious personal injury or death



Caution: This icon is present in all the operational procedures where the Improper operation can cause damage for the Thyristor unit.

CD Automation reserves the right to modify the own products and this manual without any advise.



2 Introduction

A thyristor unit is semiconductor device which acts as a switch formed by two thyristors in antiparallel. To switch on the alternating current the input signal will be on and the thyristor will switch off at first Zero Crossing voltage with no input signal.

The benefits of thyristor units compared with electromechanical contactors are numerous: no moving parts, no maintenance and capacity to switch very fast. Thyristors are the only solution to control transformers and special loads that change resistance with temperature and with age.

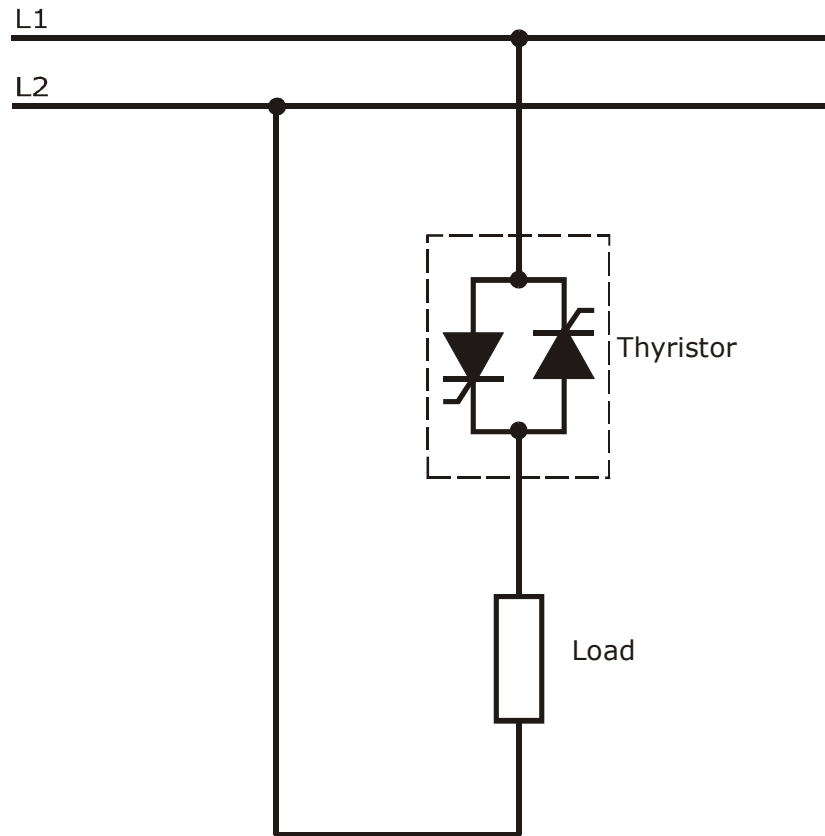

3 Quick Start



Caution: this procedure must be performed only by qualified persons.

If the Order Code of the Thyristor unit is in line with what you really need, then CD3000S has been already configured in Factory and you just need to do the following steps:

1. Verify the CD3000S Sizing. Making sure that:
 - The load current is equal or less than the MAX current of CD3000S.
 - The load voltage is equal or less than the MAX voltage of CD3000S.
 (see par. 4)
2. Verify the Order Code
(see par. 5.2)
3. Verify the Installation
(see par. 6)
4. Verify the Diagram of control connection:
 - All auxiliary connections must be done in line with wirings on this manual.
 - Verify that there isn't a short circuit on the load.
 - Verify that the Reset Contact on terminal 7 and 8 are closed.
 (see par. 7.5)
5. Supply the Electronic boards
(see Order Code)
6. Supply the Fan at 230VAC $\pm 15\%$ 50/60Hz (110VAC $\pm 15\%$ 50/60Hz Optional)
(see par. 8.2)

The CD3000S Thyristor unit is ready to start.

4 CD3000S Sizing

4.1.1 Star wiring with resistive load

$$I = \frac{P}{1,73V}$$

V = Nominal voltage phase to phase

I = Nominal current of the load

P = Nominal power of the load

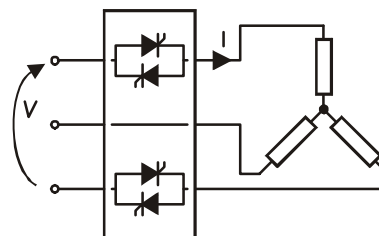

4.1.2 Delta wiring with resistive load

$$I = \frac{P}{1,73V}$$

V = Nominal voltage phase to phase

I = Nominal current of the load

P = Nominal power of the load

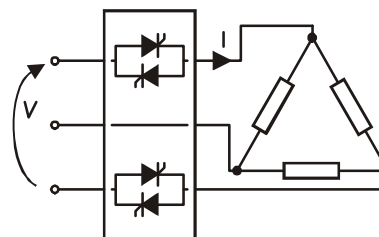

5 Identification and Order Code

5.1 Identification of the unit



Caution: Before to install, make sure that the Thyristor unit have not damages. If the product has a fault, please contact the dealer from which you purchased the product.

The identification's label give all the information regarding the factory settings of the Thyristor unit, this label is on the unit, like represented in figure.

Verify that the product is the same thing as ordered (see par. 5.2).

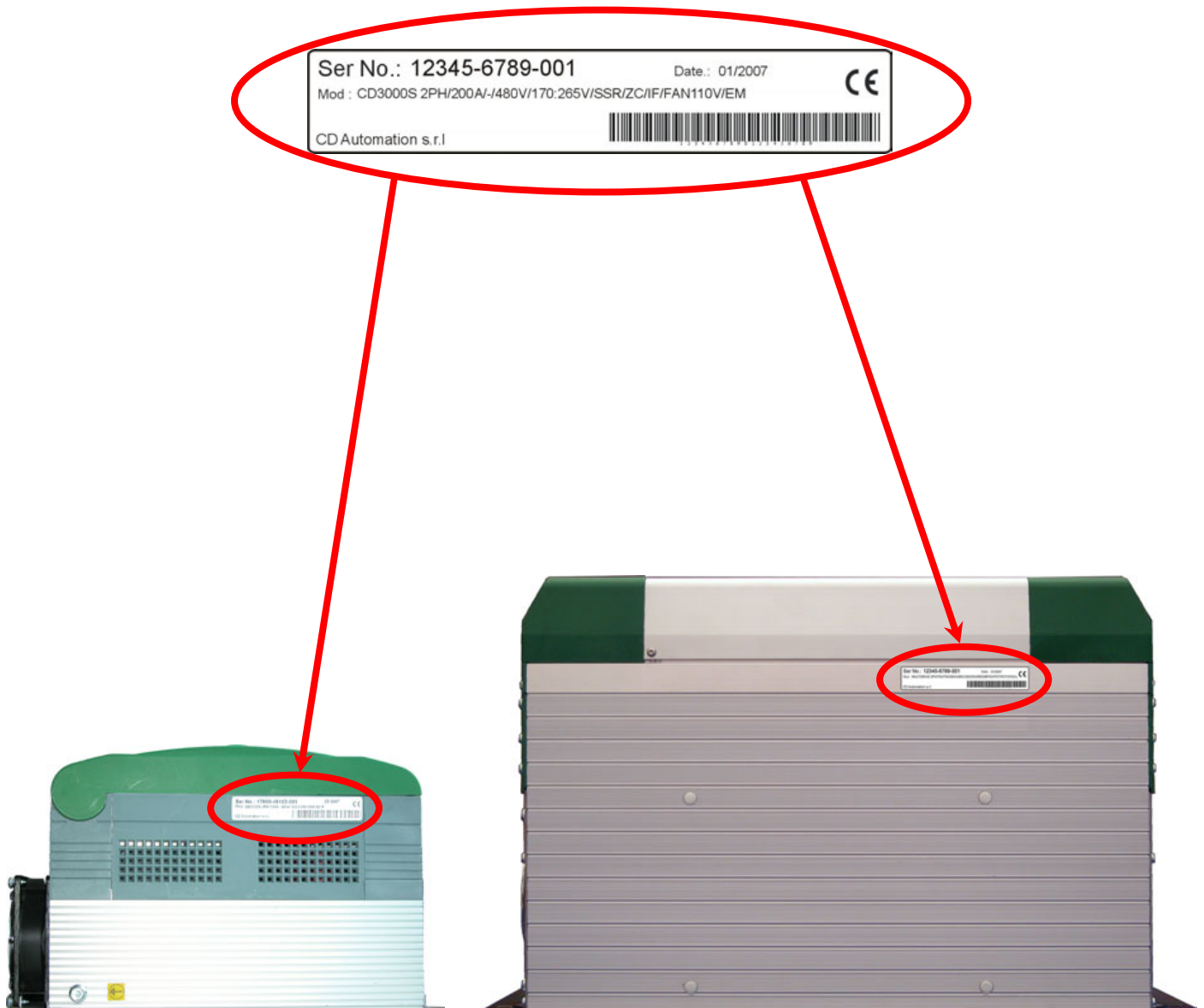

5.2 Order Code

Model	1	2	3	4	5	6	7
CD3000S-2PH							

1	Max Current of CD3000S											
	125A		200A		400A		500A		700A			
	150A		275A		450A		600A					
The Max Current must be equal or more than Load Current												

2	Load Voltage											
Specify this value to configure the unit in CD Automation												

3	Max Voltage of CD3000S											
	480V											
	600V											
The Max Voltage must be equal or more than Load Voltage												

4	Voltage supply for the Electronic boards											
	90:130	From 90 to 130Vac; 10VA										
	170:265	From 170 to 265Vac; 10VA										
	230:345	From 230 to 345Vac; 10VA										
	300:530	From 300 to 530Vac; 10VA										
	510:690	From 510 to 690Vac; 10VA										

5	Input											
	SSR	4÷30Vdc										

6	Firing Type											
	ZC	Zero Crossing										

7	Option											
	IF	Internal Fuse (standard)										
	NF	Without Fuse										
	110Fan	Fan voltage supply 110VAC ± 15% (std 230VAC ± 15%) 50/60Hz										
	UL	UL Certification										

6 Installation



Caution: Don't install near the hot elements or near the units that could give electromagnetic interferences.

The CD3000 Thyristor unit must be always mounted in vertical position to improve air cooling on heat-sink. Maintain the minimum distances in vertical and in horizontal as represented.

When more unit has mounted inside the cabinet maintain the air circulation like represented in figure. Sometimes is necessary installing a fan to have better air circulation.

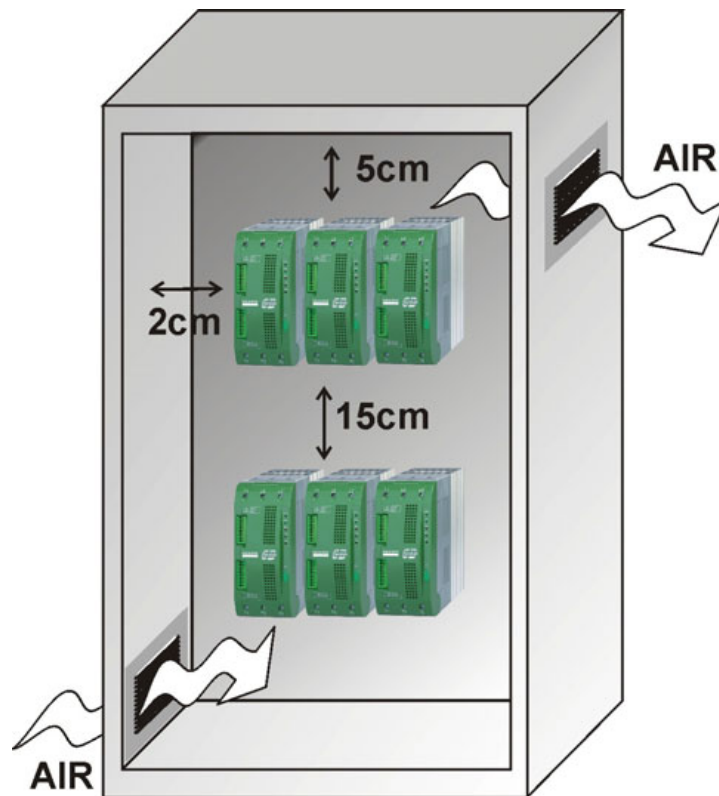

6.1 Environmental installation conditions

Ambient temperature	0-45°C at nominal current. Over 45°C use the derating curve (see par. 8.1)
Storage temperature	-25°C to 70°C
Installation place	Don't install at direct sun light, where there are conductive dust, corrosive gas, vibration or water and also in salty environmental.
Altitude	Up to 1000 meter over sea level. For higher altitude reduce the nominal current of 2% for each 100m over 1000m
Humidity	From 5 to 95% without condense and ice

6.2 Dimensions and Weight

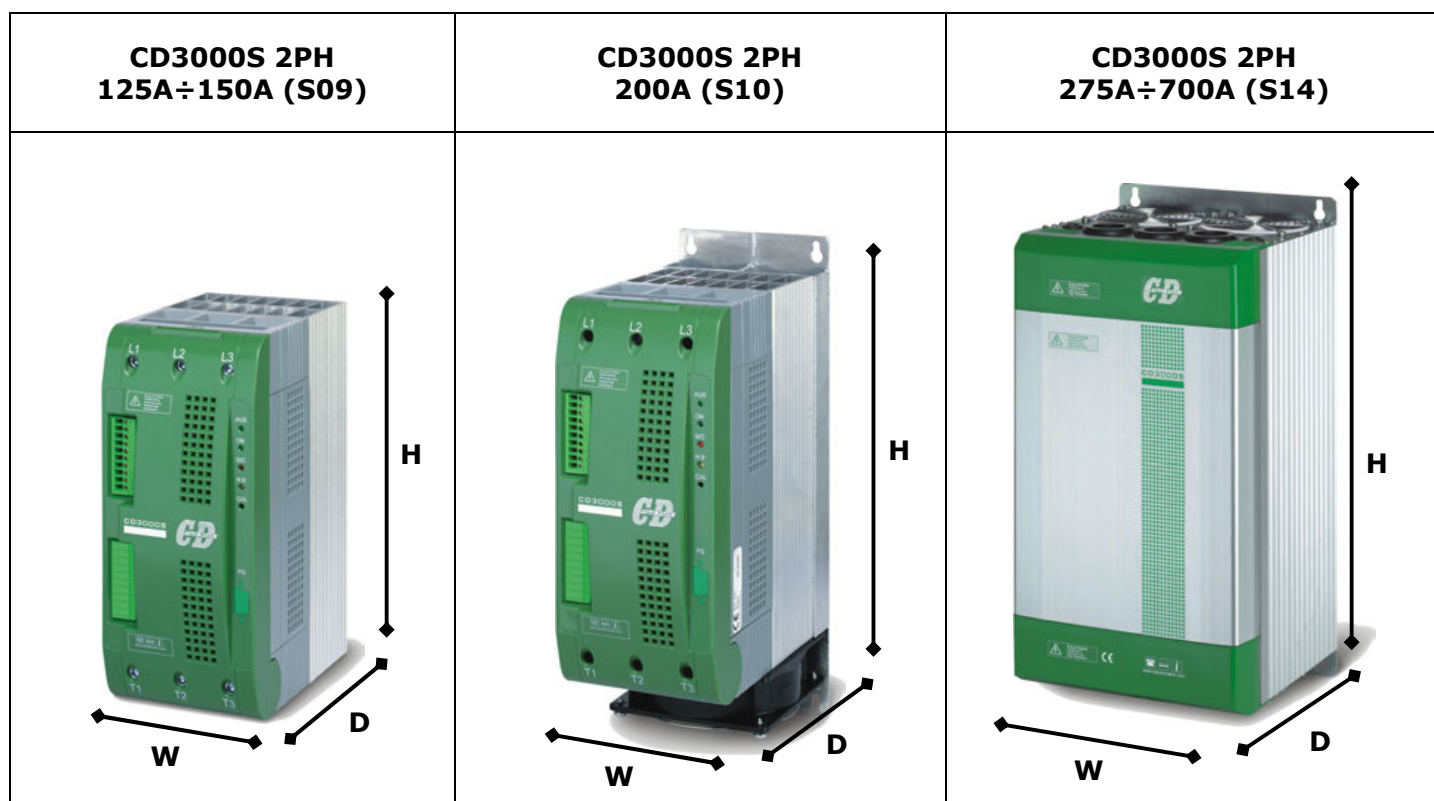

Size	W(mm)	H(mm)	D(mm)	Weight (kg)
125A (S09)	116	316	187	5
150A (S09)	116	316	187	5
200A (S10)	120	350	220	5,5
275A (S14)	262	520	270	22,5
400A (S14)	262	520	270	22,5
450A (S14)	262	520	270	22,5
500A (S14)	262	520	270	22,5
600A (S14)	262	520	270	22,5
700A (S14)	262	520	270	22,5

6.3 Fixing holes

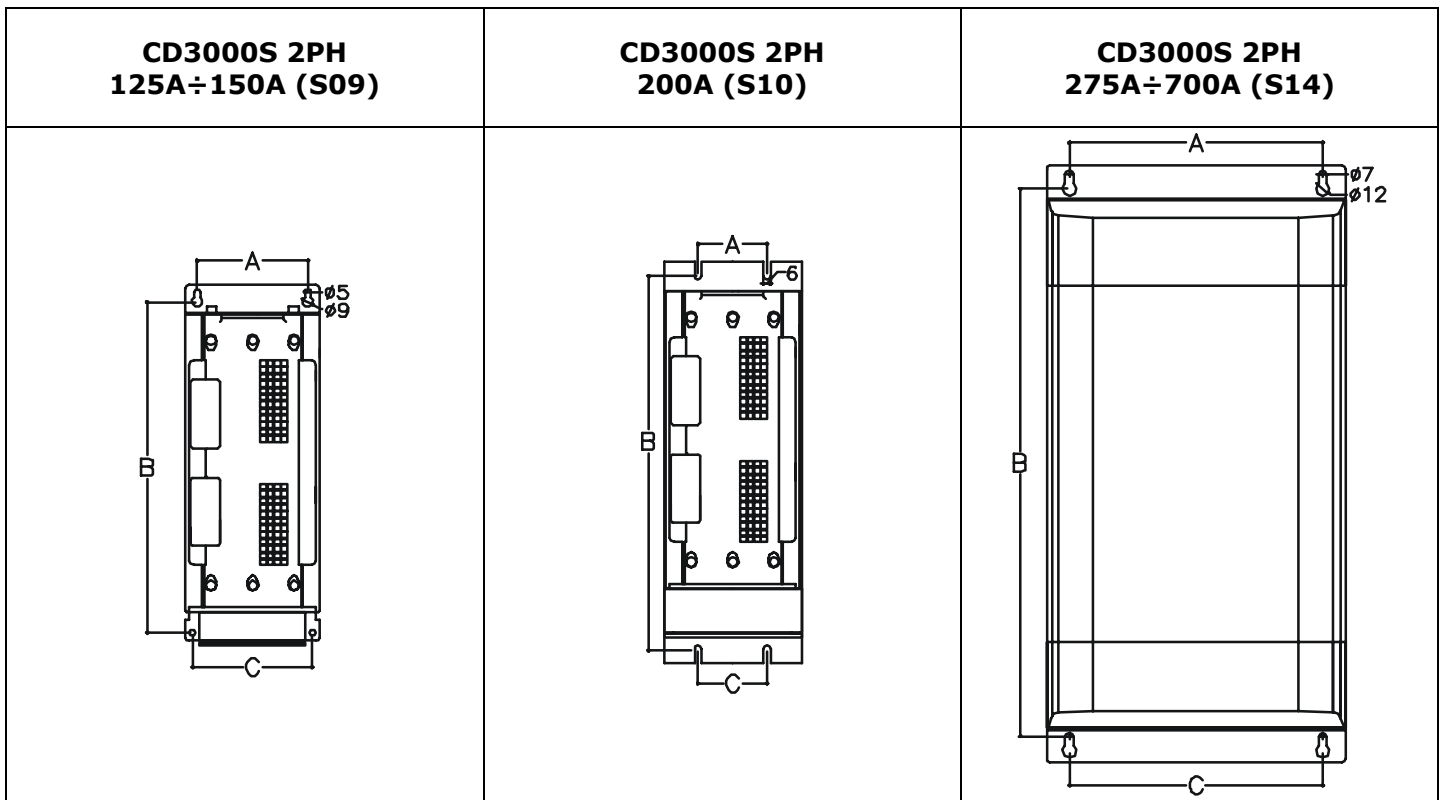

Size	A(mm)	B(mm)	C(mm)
125A (S09)	96	290	104
150A (S09)	96	290	104
200A (S10)	60	326	60
275A (S14)	222	490	222
400A (S14)	222	490	222
450A (S14)	222	490	222
500A (S14)	222	490	222
600A (S14)	222	490	222
700A (S14)	222	490	222

7 Wiring instructions



Caution: this procedure must be performed only by qualified persons.

The Thyristor unit could be susceptible to interferences lost by near equipments or by the power supply, for this reason in accord to the fundamental practices rules is opportune take some precautions:

- The electronic circuit of the Thyristor unit must be supplied from a dedicated voltage and not with inductive or capacitive loads. We recommend the use of a screened transformer.
- The coil contactor, the relays and other inductive loads must be equipped with opportune RC filter.
- Use shielded bipolar cables for all the input and output signals.
- The signal cables must not be near and parallel to the power cables.
- Local regulations regarding electrical installation should be rigidly observed.

For safety connect the heat-sink to the earth with his terminal.

7.1 Removing the cover

Instructions for open the thyristor unit size S9 and S10



Instructions for open the thyristor unit size S14



7.2 Wiring details

Use copper cables and wires rated for use at 75°C only.

7.2.1 Power cable torque (suggested)

Current	Connector Type	Torque Lb-in (N-m)	Wire Range AWG / kcmil	Wire Terminal
125A, 150A, 200A,	Terminal Block M8	265 (30.0)	1 3/0	Copper wire Compact (Solid) Stranded
275A	Bus Bar with M8 screw	505 (57.0)	2x1/0 300	UL Listed (ZMVV) Copper Tube Crimp. Lug
400A	Bus Bar with M10 screw	505 (57.0)	2x3/0 600	UL Listed (ZMVV) Copper Tube Crimp. Lug
450A	Bus Bar with M10 screw	505 (57.0)		Bus bar 30x6mm
500A	Bus Bar with M10 screw	505 (57.0)		Bus bar 60x4mm
600A	Bus Bar with M10 screw	505 (57.0)		Bus bar 60x5mm
700A	Bus Bar with M10 screw	505 (57.0)		Bus bar 60x6mm

7.2.2 Power cable dimensions (suggested)

Current	Supply			Load		
	Cable		Screw M	Cable		Screw M
	mm ²	AWG		mm ²	AWG	
125A (S09)	50	1	M8	50	1	M8
150A (S09)	70	1/0	M8	70	1/0	M8
200A (S10)	95	3/0	M8	95	3/0	M8
275A (S14)	2 x 70	2 x 1/0	M8	2 x 70	2 x 1/0	M8
400A (S14)	2 x 95	2 x 3/0	M10	2 x 95	2 x 3/0	M10
450A (S14)	Bus Bar		30 x 6 mm	Bus Bar		30 x 6 mm
500A (S14)	Bus Bar		60 x 4 mm	Bus Bar		60 x 4 mm
600A (S14)	Bus Bar		60 x 5 mm	Bus Bar		60 x 5 mm
700A (S14)	Bus Bar		60 x 6 mm	Bus Bar		60 x 6 mm

7.2.3 Cable dimensions (suggested) of Earth and of the Command Terminals

Current	Earth			Command Terminals		
	Cable		Screw M	Cable		
	mm ²	AWG		mm ²	AWG	
125A (S09)	16	6	M6	0,50	18	
150A (S09)	16	6	M6	0,50	18	
200A (S10)	25	4	M6	0,50	18	
275A (S14)	50	1	M8	0,50	18	
400A (S14)	50	1	M8	0,50	18	
450A (S14)	70	1/0	M8	0,50	18	
500A (S14)	70	1/0	M8	0,50	18	
600A (S14)	70	1/0	M8	0,50	18	
700A (S14)	70	1/0	M8	0,50	18	

7.3 Power Terminals



Warning: Before connecting or disconnecting the unit check that power and control cables are isolated from voltage sources.

Terminal	Description
L1	Line Input Phase 1
L2	Line Input Phase 2
L3	Line Input Phase 3
T1	Load Output Phase 1
T2	Load Output Phase 2 - Not controlled by the thyristor
T3	Load Output Phase 3

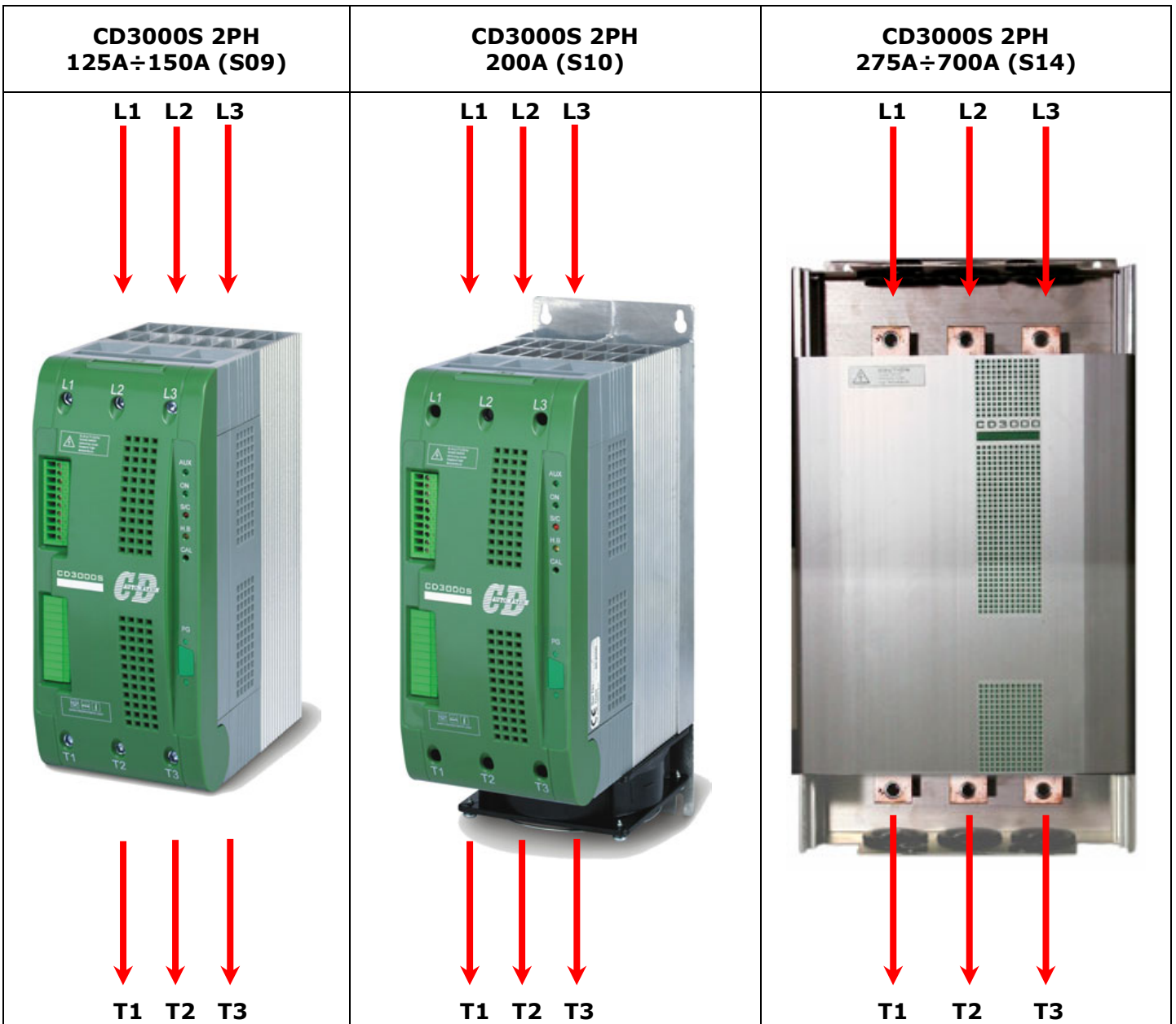

7.4 Command Terminals



Warning: Before connecting or disconnecting the unit check that power and control cables are isolated from voltage sources.

Standard Terminals

Terminal	Description
1	Voltage Supply for Electronic Boards (see par. 11.2)
2	Not Used
3	Voltage Supply for Electronic Boards (see par. 11.2)
4	Earth
5	Fan supply voltage (see par. 8.2)
6	Fan supply voltage (see par. 8.2)
7	RESET
8	RESET
9	(+)Input command signal SSR
10	(-)Input command signal SSR

Additional Terminals (only for size S14)

Terminal	Description
11	0V GND
12	Output +8Vdc stabilized 1 mA MAX
13	(+)Output command for Slave unit
14	(-)Output command for Slave unit
15	Not Used
16	Not Used
17	Not Used
18	Not Used
19	Not Used
20	Not Used



7.5 Diagram of control connection



Caution: this procedure must be performed only by qualified persons.

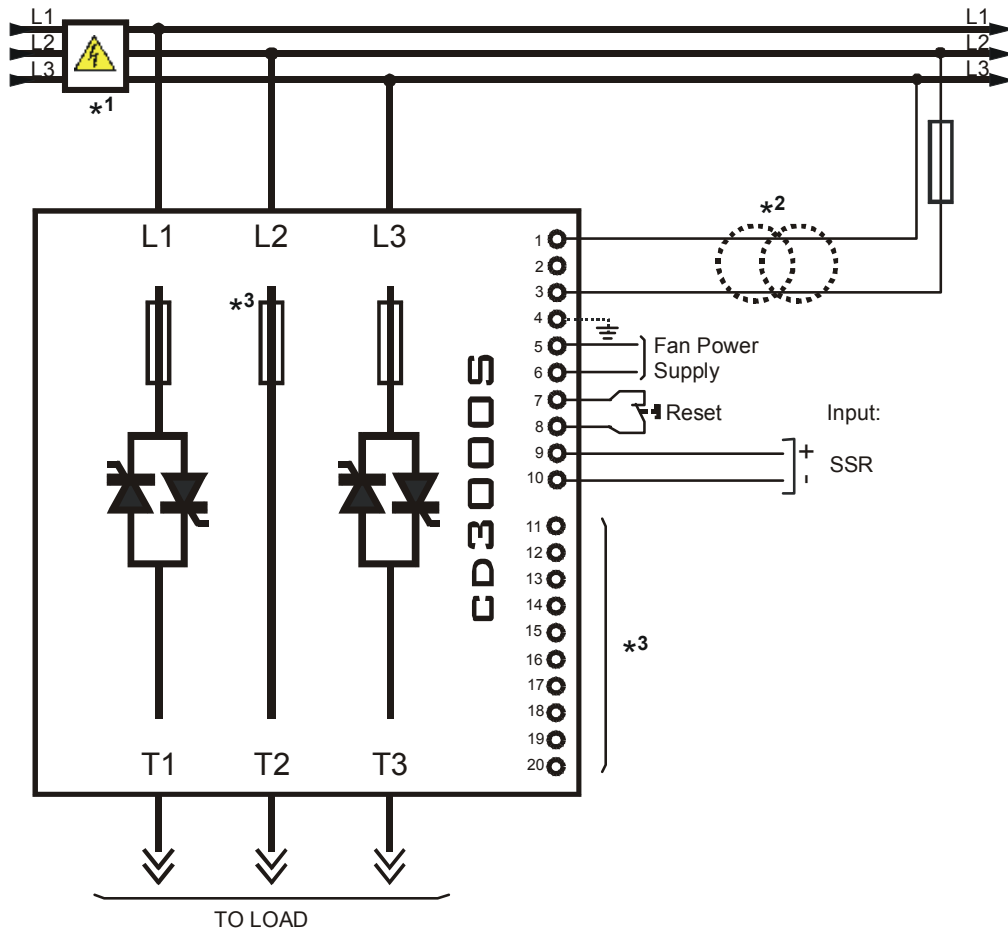

NOTE:

- *1 The user installation must be protecting by electromagnetic circuit breaker or by fuse isolator.
- *2 Use an appropriate external transformer based on the voltage supply of the electronic board (see the identification label)
- *3 only for size S14
- To work, the Reset Contact on terminal 7 and 8 must be closed.

Load Type

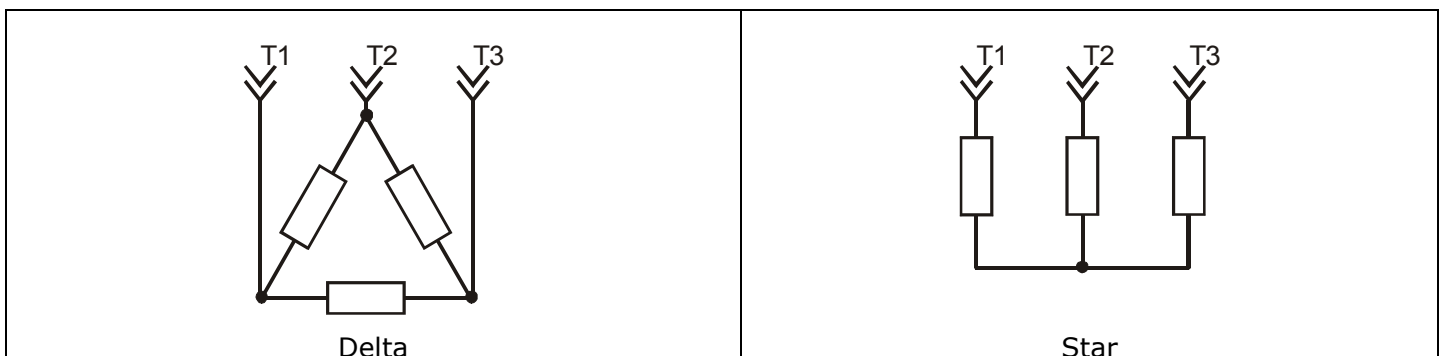

8 Power output features

Current (A)	Voltage range (V)	Repetitive peak reverse voltage		Latching current (mAeff)	Max peak one cycle (10msec.) (A)	Leakage current (mAeff)	I ² T value max tp=10msec	Frequency range (Hz)	Power loss I=Inom (W)	Isolation Voltage Vac
		(480V)	(600V)							
125A	24÷600	1200	1600	450	2000	15	19100	47÷70	255	2500
150A	24÷600	1200	1600	300	5250	15	128000	47÷70	268	2500
200A	24÷600	1200	1600	300	5250	15	128000	47÷70	380	2500
275A	24÷600	1200	1600	300	4800	15	108000	47÷70	623	2500
400A	24÷600	1200	1600	200	7800	15	300000	47÷70	875	2500
450A	24÷600	1200	1600	200	7800	15	300000	47÷70	1021	2500
500A	24÷600	1200	1600	200	8000	15	306000	47÷70	1061	2500
600A	24÷600	1200	1600	1000	17800	15	1027000	47÷70	1178	2500
700A	24÷600	1200	1600	1000	17800	15	1027000	47÷70	1425	2500

8.1 Derating curve

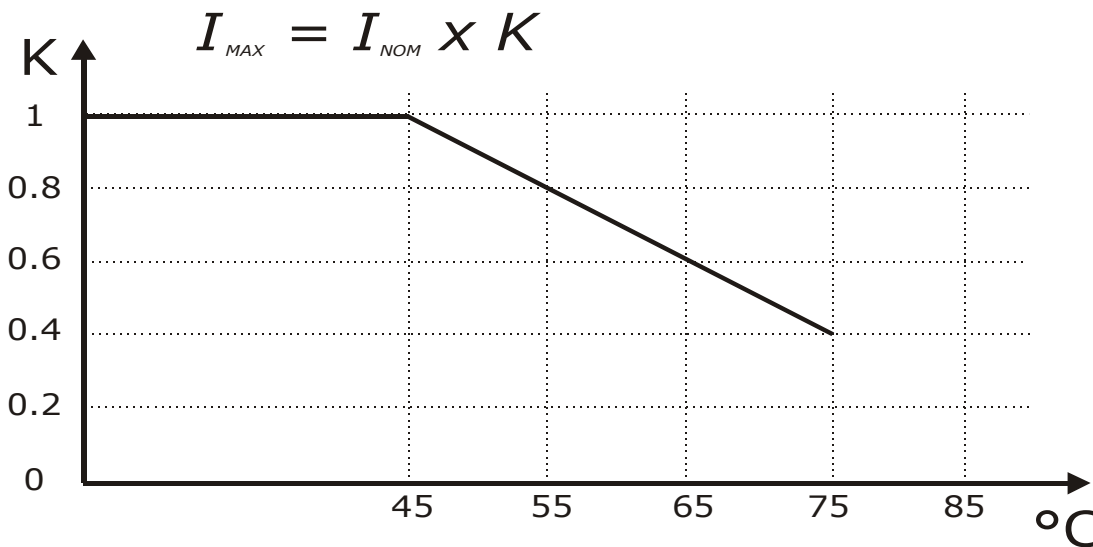

8.2 Cooling fans

The CD3000S thyristor unit is equipped with a cooling fans. The supply voltage is standard 230VAC ±15% 50/60Hz or optional 110VAC ±15% 50/60Hz.

The fan's power consumption is below listed:

Size	CE Number of fans	cUL us LISTED Number of fans
125A, 150A, 200A	One Fan - 14W	One Fan - 14W
400A, 500A, 600A	Two Fans - 30W	Four Fan - 60W
275A, 450A, 700A	Four Fan - 60W	Four Fan - 60W

9 Led status and Alarms

9.1 LED Status Table

On the CD3x00 Electronic board there are two LED that indicates the state of the Electronic cards:

LED For All size	STATUS	DESCRIPTION
Aux	○	The power supply is not connected or fault on the electronic board
	●	Power supply and Electronic board is OK
ON	○	OFF Condition(Load IS NOT Powered)
	●	ON Condition(Load IS Powered)
	○	= OFF
	●	= ON

10 Firing type

The firing type has already configured in line with customer requirements that are defined in the Order Code. The Order Code is written on the identification label.

10.1 Zero Crossing (ZC)

ZC firing mode is used with Logic Output from temperature controllers and the Thyristor operates like a contactor.

The Cycle time is performed by temperature controller. ZC minimizes interferences because the Thyristor unit switches ON-OFF at zero voltage.

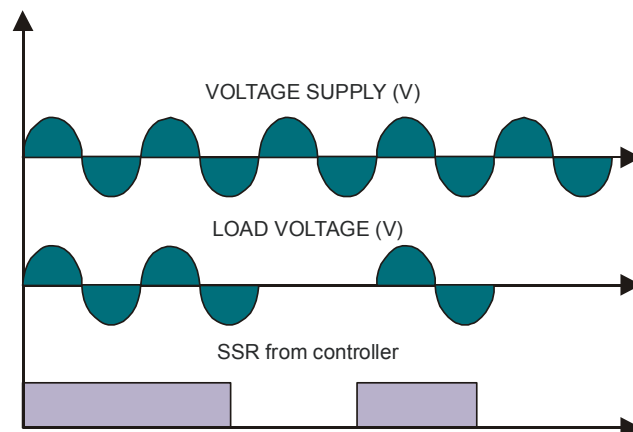

11 Connection description

11.1 Access to the Electronic boards

To have access to the electronic boards the user must removing the unit's cover (see par.7.1)



Warning: Before operate, be sure that power and control cables are isolated from voltage sources

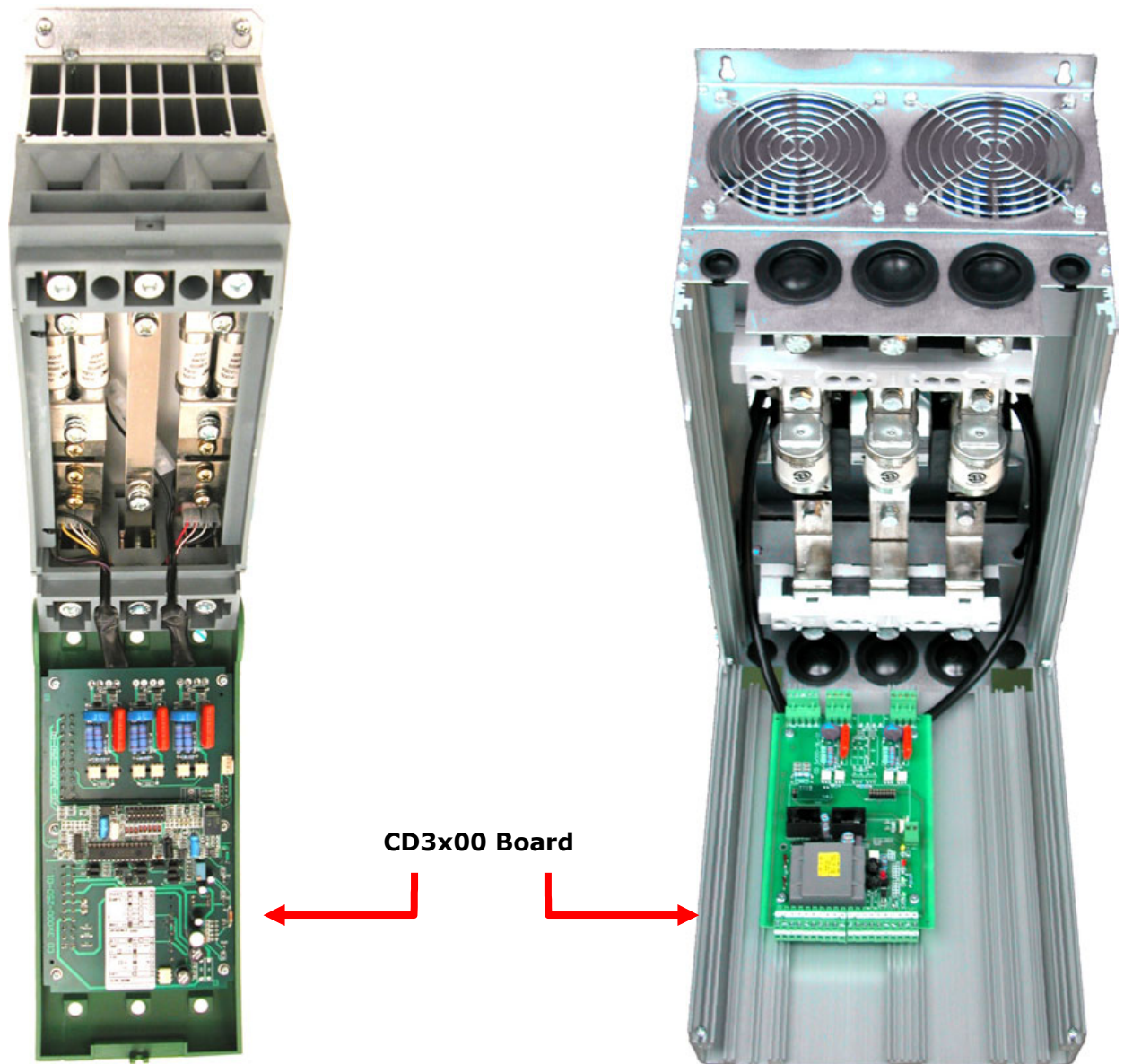

11.2 Supply the Electronic Board

The CD3000S thyristor unit, to work, requires a voltage supply for the electronic board.
The consumption is 10VA max.

The voltage supply for the electronic board is configured in line with customer requirements that are defined in the Order Code. The Order Code is written on the identification label.



Warning: Before connecting or disconnecting the unit check that power and control cables are isolated from voltage sources.

Terminal	Description
1	Voltage Supply for Electronic Board
2	Not Used
3	Voltage Supply for Electronic Board
4	Earth

To change auxiliary supply voltage sold the correct link-jumper on CD3x00 board
The type of mounted transformer depends of the chosen Voltage in the order code.
(See par. 5.2)

Size S09 and S10		Size S14	
Link-Jumper J9+J11 	Link-Jumper J10 	Link-Jumper J9+J11 	Link-Jumper J10

Transformer Type	Link-Jumper J9+J11	Link-Jumper J10
TR-605 120V	90:130V	-
TR-605 230V	170:265V	300:530V
TR-605 300V	230:345V	510:690V

If the Auxiliary Voltage (written on the identification label) is different from Supply Voltage (to the load), use an external transformer with primary equal to load voltage and secondary equal to the Auxiliary Voltage.

11.3 Input command

The CD3000S thyristor unit have an input of command to drive the output power

11.3.1 Input command signal configuration (Terminals 9 and 10 - see par. 7.4)

The Input command signal is already configured in line with customer requirements that are defined in the complete product code. The product code is written on the identification label. However, if you wish to see the jumper configuration see below:



Caution: this procedure must be performed only by qualified persons

Type	Input features		J7	J13	J16	J17
SSR	Current drain	5mA	OPEN	CLOSE	A-B	A-B
	ON	≥ 4Vdc Max 30Vdc				
	OFF	< 1Vdc				

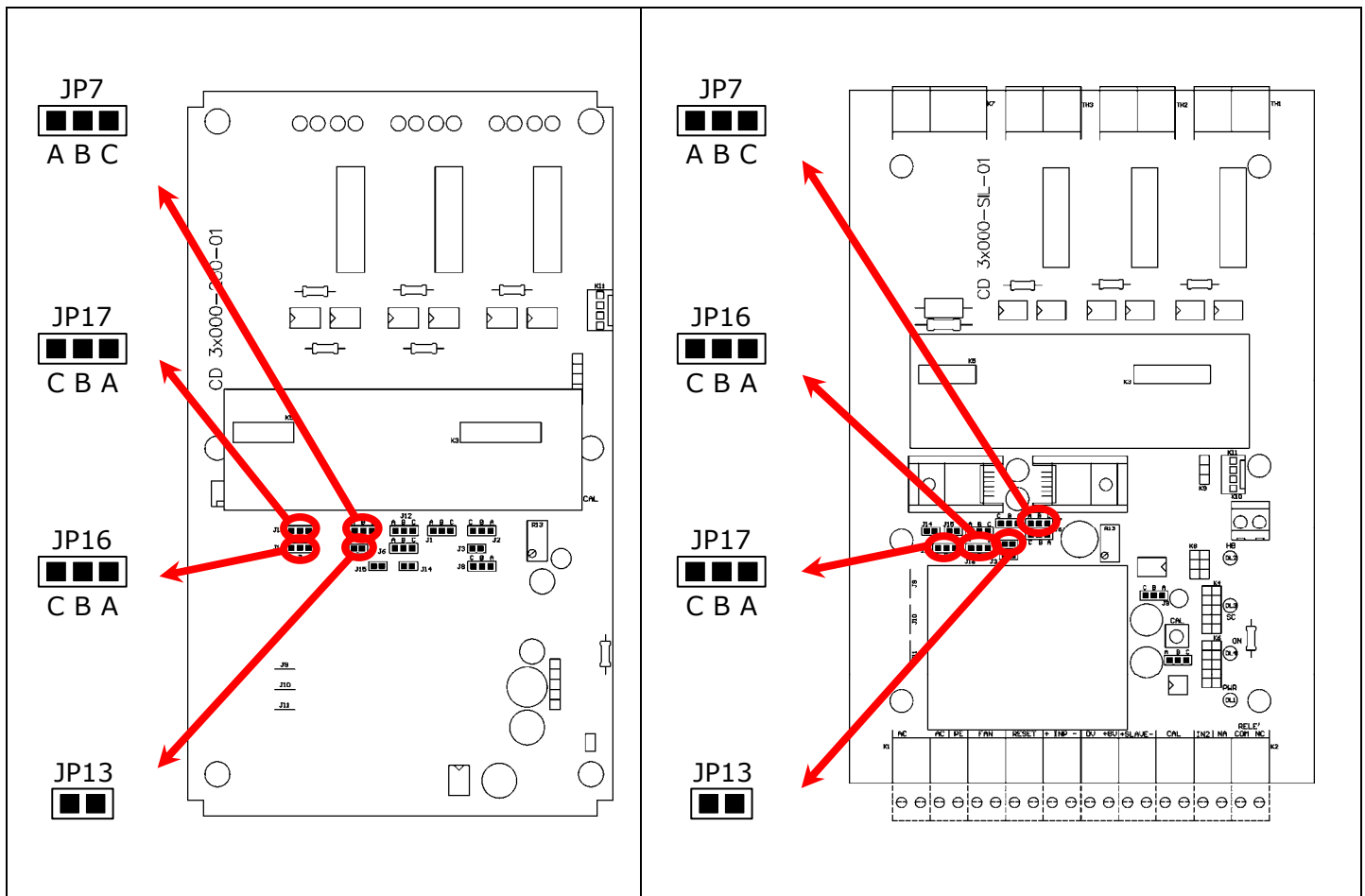

11.4 Digital Input

CD3000S thyristor unit has one digital input.

11.4.1 Reset (Terminals 7 and 8 see par. 7.4)

Open link to terminals 7-8 to stop the CD3000S thyristor unit.

12 Internal Fuse

The CD3000S thyristor unit have internal fuse extrarapid at low I^2t for the thyristor protection of against the short-circuits.

The fuse must have I^2t lower than the thyristor one (I^2t max)



Caution: USE ONLY EXTRARAPID FUSE WITH APPROPRIATE I^2t

12.1 Fuse Code

Size	200 kARMS Symmetrical A.I.C.				Qty
	Fuse CODE	Current (A RMS)	I^2T (A ² sec)	Vac	
125A (S09)	FU200FEE	200	11400	660	2
150A (S09)	FUURB250	250	52000	660	2
200A (S10)	FUURB315	315	82000	660	2
275A (S14)	FUURB315	315	82000	660	3
400A (S14)	FU550FMM	550	215000	660	3
450A (S14)	2xFU315FMM	630	310000	660	3
500A (S14)	2xFU315FMM	630	310000	660	3
600A (S14)	2xFU450FMM	900	420000	660	3
700A (S14)	2xFU450FMM	900	420000	660	3



Caution: The Fuses must have I^2t 20% less than thyristor's I^2t .



Caution: High speed fuses are used only for the thyristor protection and can not be used to protect the installation.



Caution: The warranty of thyristor is null if no proper fuses are used. See tab.



Warning: The user installation must be protected by electromagnetic circuit breaker or by fuse isolator.



13 Maintenance

13.1 Trouble Shooting

Small problems sometimes can be solved locally with the help of the below tab of trouble shooting. If you don't succeed, contact us or your nearest distributor

Symptom	Indication on front unit	Possible reasons of the symptom	Actions
Thyristor unit doesn't go in conduction with input signal	Green LED (Aux) is always light off	<ul style="list-style-type: none"> No voltage auxiliary power 	<ul style="list-style-type: none"> Give auxiliary voltage supply (see wiring diagram)
	Green LED (Aux) light on Green LED (ON) light off	<ul style="list-style-type: none"> No input signal Reversed polarities of input signal Reset contact is open 	<ul style="list-style-type: none"> Provide to give input signal Reverse the input signal polarity Make link on reset terminals (see wiring diagram)
	Green LED (Aux) light on Green LED (ON) light on	<ul style="list-style-type: none"> Fuse failure Load failure Load connection interruption Thyristor faulty and always in open circuit With HB option the yellow led (HB) is light on	<ul style="list-style-type: none"> Substitute the fuse Check the load Check the wiring Substitute the faulty thyristor
Load current flows also with no input signal	Green LED (ON) is always light off.	<ul style="list-style-type: none"> Wrong wiring Short circuit on thyristor If there is HB option the red LED (SC) is light on	<ul style="list-style-type: none"> Check the load wiring Substitute the thyristor
Thyristor unit doesn't work properly		<ul style="list-style-type: none"> Auxiliary voltage supply out of limits 	<ul style="list-style-type: none"> Verify the auxiliary voltage supply

13.2 Fans

The thyristor unit with forced ventilation uses fans that rotate permanently when the unit is supplied. In case of fan failure, the heat-sink can reach high temperature. In this case to give protection to thyristor there is a thermal switch properly setted. The function of this switch is to open the input signal until the heat-sink temperature falls below the setted value. This means that also with input signal in ON condition the unit is switched OFF and the system can not work at full power. For this reason is important to control periodically the fans status checking that are rotating.

13.3 Maintenance

For maintain a correct cooling, the consumer must clean the heat-sink and the protective grate of the fans. The frequency of these operations depends on the atmospheric local pollution. Check also that the screw of the power terminals and earth terminals are shut correctly (see Diagram of control connection).

13.4 Repairing procedure

- Phone to CD Automation.
- Explain to Service Engineer the problem because sometimes it can be solved with a phone call. If this is not possible, ship the unit to CD Automation or to your distributor.
- Write a fault description and give the name of your personnel to which refers.
- Use a rugged packaging to ship the unit.

13.5 Warranty condition

CD Automation gives a 12 months warranty to its products. The warranty is limited to repairing and parts substitution in our factory and does exclude products not properly used and fuses. Warranty does not include products with serial numbers deleted. The faulty product should be shipped to CD Automation at customer's cost and our Service will evaluate if product is under warranty terms. Substituted parts remain of CD Automation property.