

CAL 6000 TEMPERATURE CONTROLLER INSTALLATION AND OPERATING MANUAL

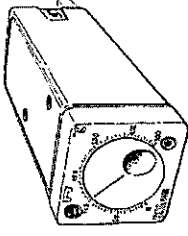

The Model 6000 is a time proportioning analogue temperature controller which will provide stable and reliable control for the majority of applications, with minimum overshoot on warm up.

Installation and Connection Diagram For:

Model 6300 Panel mounting

Model 6200 Plug-in, adjustment on top

Model 6100 Plug-in, remote adjustment

INSTALLATION - IMPORTANT SAFETY INFORMATION PLEASE REVIEW

Designed for use: Within Installation Category II environment and pollution degree 2 as defined in EN61010-1;

To avoid possible hazards, accessible conductive parts of final installation should be protectively earthed in accordance with EN61010 for Class 1 equipment.

Output wiring should be within a grounded cabinet. Sensor sheaths should be bonded to ground or not be accessible. Live parts should not be accessible without use of a tool.

It is the responsibility of the installation engineer to ensure that this equipment's compliance to EN61010 is not impaired when fitted to the final installation, and to use this equipment as specified in this manual. Failure to do so may impair the protection provided.

ELECTRICAL INSTALLATION (follow wiring diagrams and regulations).

CAUTION RISK OF ELECTRICAL SHOCK.

1. Check controller label shows the correct supply voltage for the application.
2. Connections are shown on the side label.
3. For connection to 6300, type Faston receptacles are provided in accessory kit.
4. Recommended wire size for mains voltage 32/0.2, 1.0mm² (18 AWG 0.04"*) rated to 6 Amps/300V at 70°C. (For 10 Amp relay use 10Amp/300V at 70°C)

Ultimate Safety Alarms. Do not use this equipment solely when personal injury or damage may be caused by equipment failure.

Cleaning - if required wipe with damp cloth (water only).

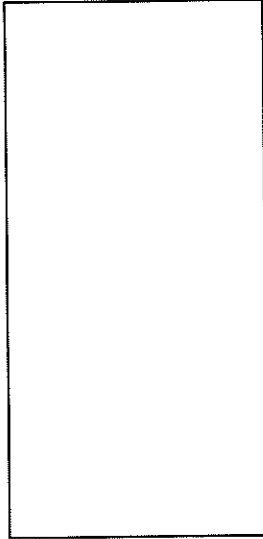

WARRANTY

CAL Controls warrant this product free of defects in workmanship and materials for two (2) years from date of purchase.

1. Should the unit malfunction, return it to the factory. If defective it will be repaired or replaced at no charge.
2. There are no user-serviceable parts in this unit. This warranty is void if the unit shows evidence of being tampered with or subjected to excessive heat, moisture, corrosion or other misuse.
3. Components which wear, or damage with misuse, are excluded e.g. Relays.
4. To comply with this warranty the installation and use must be by suitably qualified personnel.
5. Neither CAL Controls Ltd or CAL Controls Inc shall be responsible for any damage or loss to other equipment however caused, which may be experienced as a result of the installation or use of this product. CAL Controls liability for any breach of this agreement shall not exceed the purchase price paid.

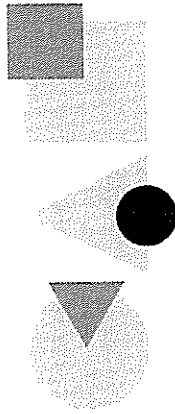

CAL Controls Ltd

Bury Mead Road, Hitchin, Herts. SG5 1RT, UK
Tel: + 44 (0) 1462-436161 Fax: + 44 (0) 1462-451801

CAL Controls Inc

1117 S. Milwaukee Avenue, Libertyville, IL 60048, USA
Tel: (847) 680-7080 Fax: (847) 816-6852

CAL Controls policy of continuous development may cause detail changes to the enclosed information. E & OE

Installation Diagrams

Model 6300

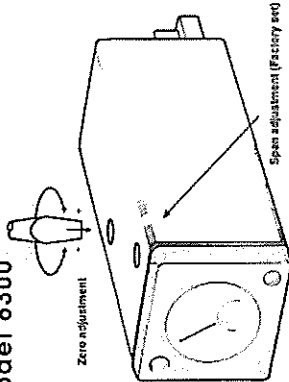

Time proportioning provides smooth control but the actual process temperature may be slightly offset from the setpoint. This error may be removed with the "zero" adjustment. Clockwise to increase and anti-clockwise to decrease the reading.

EITHER through a 45 x 45mm (1.77 x 1.77) DIN panel cutout

OR through 3 x 6mm (0.31) holes

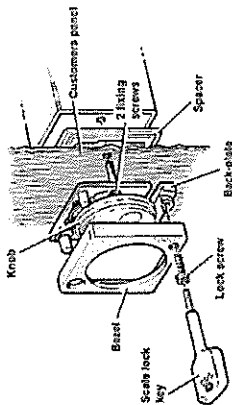
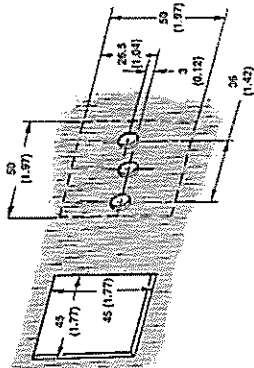

INSTALLATION 61-SA

Model 6200

PLUG IN UNITS

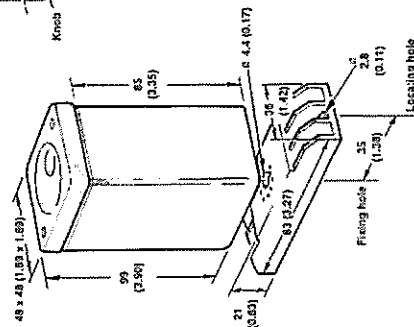

Model 6100

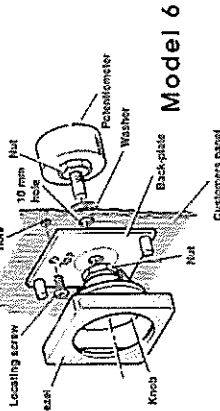

KNOB POSITIONING 61-SA

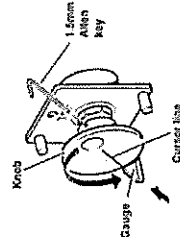

Connection Diagrams

6300

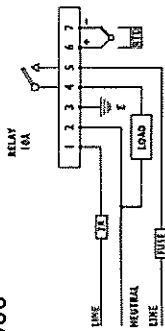

6300

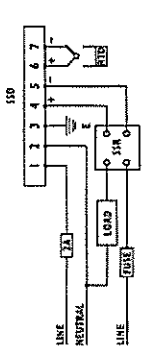

6100/6200

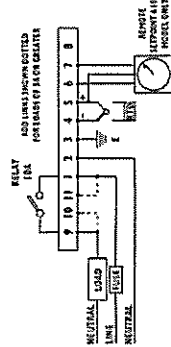

6100/6200

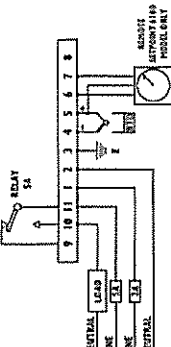

FUSES 250V AC TIME LAG TYPE TO IEC 127

SPECIFICATION

Supply Voltage: 115 or 230 ± 10% 50 TO 60 HZ
Power Consumption: 4VA maximum
Output: Relay 10A/250V SSST
Relay 5A/250V S2D1
S2D 12V at 25mA \pm cc (non isolated)

Inputs: Thermocouples J,K,T,R and S (to be specified when ordered); PT100/RTD 2 wire DIN 43760.

Sensor Load Resistance: 100 Ohms maximum.
Sensor Burnout: Upscale.
C/C Rejection: 15 to 1 Typical.
Common Mode Rejection: Negligible up to 250Vcc.
Signal Mode Rejection: Negligible up to full scale mV.

* Calibration Accuracy: ±2% FS or 4°C which ever is the greater.
* Spanning Linearity: 6100/6300 ± 1%
6200/6300 ± 1%

* Settling Resolution: ±1%
* Control Accuracy: ±0.5% or ±1°C dependant on application.
* Reference Conditions: 22°C ±2% after 30 mins. settling time.

Control: Proportional band fixed 10°C.
Proportional time 25s.
ON/OFF optional. Hysteresis 4°C.
High Brightness red LED.

Indication

Environmental

Safety: EN61010 Installation Category 2, Pollution Degree 2.
EMC: EN50091-1, FCC Rules 15, Sub Part J, Class

Immunity EN60092-1.

A: 0 to 50°C

BMC: 80% maximum.

Humidity: Below 2000M

Altitude: 2000g

Weight: 200g

Construction: Cast. Flame retardant polycarbonate.
Knob/Back-plate: Flame retardant ABS - Nektal Coated

ORDERING INFORMATION

When ordering you are welcome to do so by description or by the code below, also providing a check list. Standard options - indicated by codes in BOLD type.

Series	6000 Mounting 5/7000 Display	Output	Supply, Set Point	Sensor	Range
--------	------------------------------	--------	-------------------	--------	-------

CONTROLLER SERIES

6000	15000	7000
------	-------	------

CODE	6000	15000	7000
Mounting	Plug-in, remote adjustment	1	2
6000	Plug-in, adjustment on top	1	2
5000/7000	Non indicating	1	2
5000/7000	Digital display	1	2
5000/7000	Monitor 5" Digital display	1	2
Output	10A/250vac, relay SPST	0	1
SP1 Master	10A/250vac, relay SPST	1	2
SP1 Master	20A/250vac, relay SPST	1	2
SP1 Master	5A/250vac, relay SPST	3	4
SP1 Master	5A/250vac, relay DPDT	4	5
SP1 Master	2A/250vac, SSR SPST	5	6
SP1 Master	SSD	6	7
SP1 Master	4-20mA linear current	7	8
SP1 Master	Both 5A/250vac, relays SPDT	8	9
SP1 Master	SPECIAL Controller prefix	9	0
Supply	5000/7000	1	2
Supply	Dual voltage	1	2
Supply	115/220V	1	2
Supply	6000	1	2
Supply	Single voltage	1	2
Supply	115V	1	2
Supply	50-60Hz	1	2
Supply	220V	1	2
Supply	24V	1	2
Supply	50-60Hz	1	2
Supply	12Vdc	1	2
Set Points	6000 One set point-No code	1	2
Set Points	5000/7000 One set point	1	2
Set Points	5000/7000 High or Low limit	3	4
Set Points	7000 Out of limits	3	4
Sensor	I-C	J	K
Sensor	NC-NA	J	K
Sensor	PT13%Rh-Pt	J	K
Sensor	PT10%Rh-Pt	J	K
Sensor	CU-CON	J	K
Sensor	PT100 (RTD)	J	K
Range	5000/6000	1	2
Range	-50/150C	1	2
Range	-100/200C	1	2
Range	0/100C	1	2
Range	50/150C	1	2
Range	50/250C	1	2
Range	50/350C	1	2
Range	50/450C	1	2
Range	0/400C	1	2
Range	0/600C	1	2
Range	0/800C	1	2
Range	0/1000C	1	2
Range	0/1200C	1	2
Range	0/1600C	1	2
Range	0/200F	1	2
Range	0/300F	1	2
Range	0/500F	1	2
Range	0/800F	1	2
Range	0/1000F	1	2
Range	0/1500F	1	2

Abbreviations

Tp5 = proportioning time/cycle rate of 5 sec.
 Xp3 = proportioning band/gain of 30C.
 P = proportional
 PD = proportional + derivative
 SPST = single pole single throw contacts
 SPDT = single pole double throw contacts
 (= single pole change-over)
 H4 = on/off 40C switching differential

Examples of Controller Codes

- 6000 controller, 10A relay, panel mounting, 220Vac, proportional mode, NC-NA(K) sensor, range 50-450C, Code 6302KG
- 6000 controller, 2A SSR, plug-in top adjust, 115Vac, proportional mode (cycle rate 2 sec), I/C sensor, range 0/600C, Code 6251JH (Tp2)
- 5000 controller, 20A relay, on/off mode, I/C sensor, range 50/250C, Code 5121JD
- 7000 controller, bar display, 10A relay, PD mode, PT100/RTD sensor, range 0/300F, Code 7211P2
- 7000 controller, digital display, 2 set points, Master (SP1) 10A SPDT relay, PD (cycle rate 5 sec, proportioning band 30C), Second set point (SP2) 5A SPDT relay, PT100 sensor, range 0/100C, Code 7312PB (Tp5 - Xp3)

- Notes:**
- Unless specified otherwise:
 Output relay sense-energised below set point.
 Output relay is de-energised on sensor break.
 - Two set point controllers:
 The 6200 is available with either high/low limit, or in heat/cool mode - see page 22.
 All controllers are available with SSR or Ssd outputs as an alternative on SP1 or SP2.
 Out of limit alarm is available on 7000.
 An independently set SP2 is available on 7300.
 - Special temperature ranges and customised bearings available on quantity orders.

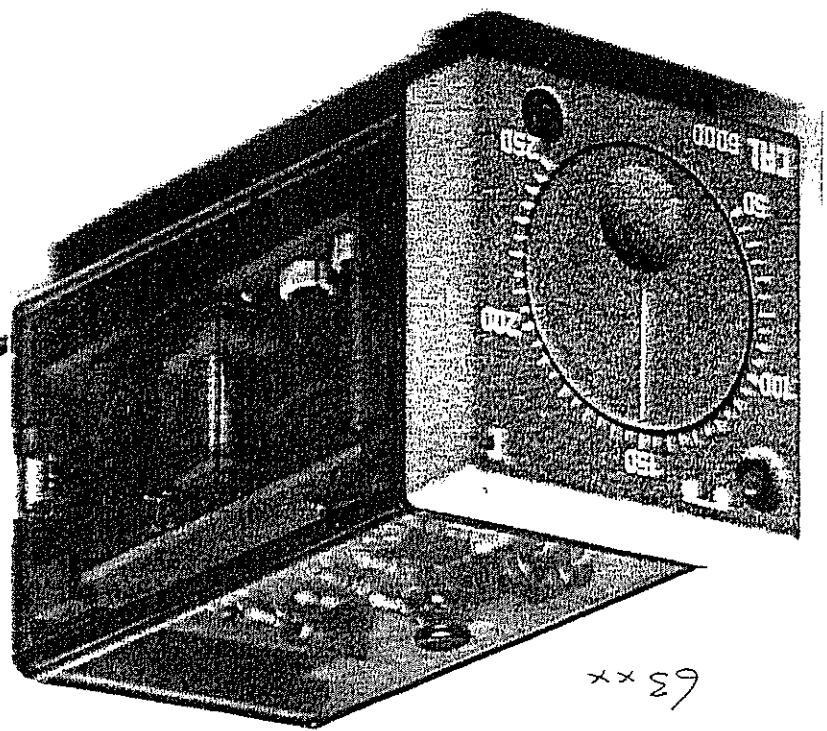

63xx

panel mounting, the most popular model, mounts in a 45 x 45mm cutout or through 3 x 8mm holes. The clear scale (50mm-3.2") is lockable, even when unlocked the unique design minimises accidental movement. LED shows 'heat ON'.

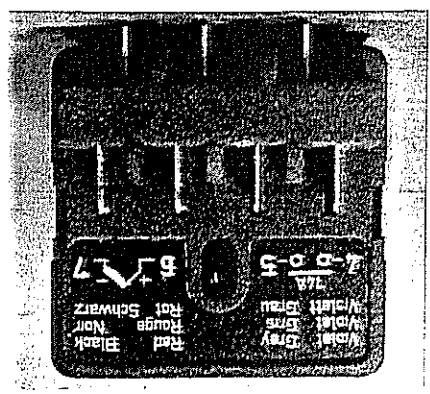

63xx

easy connections, vital as a high volume OEM product. 7 Faston connectors with colour coded boots and clear labelling ensure this.

62xx



WAS R 6102 New 62xx

plug-in or panel mounting, identical to the 63xx but with 11 round pin plug/socket. When not panel mounted, the 62xx can plug into a standard surface or PCB mounted socket. For use as a plug-in panel adjustable controller, fit through a clearance hole in the panel into a socket mounted behind.

plug-in with remote scale (scale 61-SA and 61-Pot illustrated) Mounted on surface or PCB socket. The remote setting potentiometer is panel mounted, either using the customer's own scale or the 61-SA.

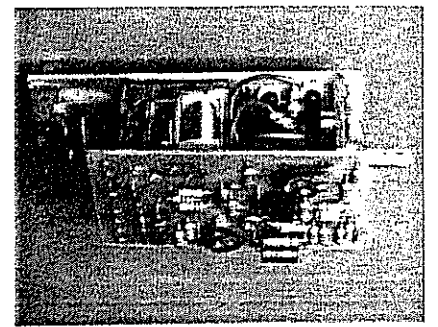

Inside a 6000, although compact, these are quality controllers. The design, components used, manufacturing standards and arduous test and 'burn-in' are geared to provide an accurate and reliable product.

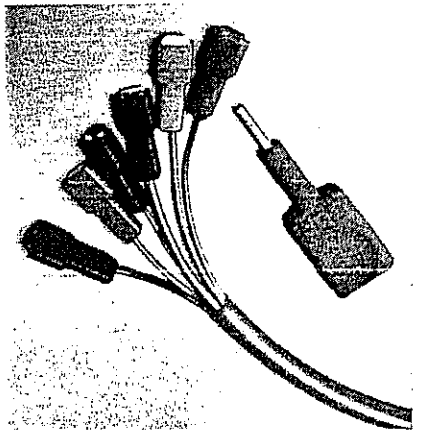

Accessories, scale lock key, tabs, coloured boots and 61-SK socket.

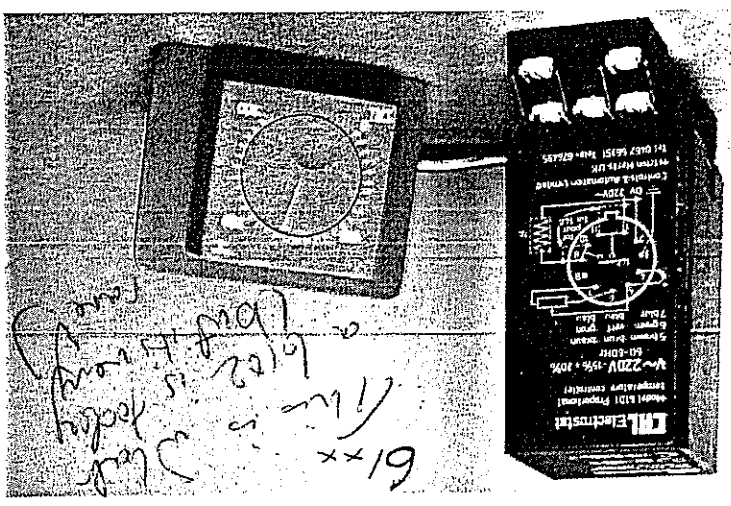

61xx New 6101 New 61xx

WAS R 6101

LTL 6101 New 61xx