

# **Modular Controllersystem Cd vario**

**Functional description**

**9499 040 70511**

**valid from 3/2004**

CD Automation srl  
All rights reserved. No part of this document may be  
reproduced or published in any form or by any means without prior written permission  
by the copyright owner.

A publication of CD Automation srl

Subject to change without notice

CD Automation srl  
Via Picasso 34/36  
Legnano 20025 (MI)  
Italy

Restriction of warranty:

No warranty is given for the complete correctness of this manual, since errors can never be avoided completely despite utmost care. Any hints are welcome and gratefully accepted.

# Functional-Description CD vario

## Contents

(This table of contents was created automatically by the text processing system.  
Consequently, the page numbers might be shifted ( $\pm 1$ ).)

1	Introduction .....	7
2	Creating a project .....	7
2.1	General information for operation of BlueControl .....	8
2.2	Adjusting the start options .....	8
2.2.1	Language .....	8
2.2.2	Options .....	9
2.2.2.1	General settings .....	9
2.2.2.2	Device selection .....	10
2.2.2.3	Windows .....	10
2.3	Signification of icons .....	11
2.3.1	Open an existing project .....	12
2.3.2	Open the last project .....	12
2.3.3	Generate a new project .....	12
3	Connection wizard .....	13
3.1	System configuration .....	14
3.1.1	VARIO module current consumption .....	15
3.2	Controller .....	17
3.3	Inputs .....	17
3.3.1	Input allocation .....	18
3.3.1.1	Unused inputs .....	19
3.4	Changeover signals .....	19
3.5	Outputs .....	19
3.6	Group alarms .....	21
3.6.1	Fail .....	22
3.6.2	Lim1, Lim2, Lim3 .....	22
3.6.3	Loop alarm .....	23
3.7	<i>HC alarm</i> (heating current monitoring) .....	23
3.7.1	Control/alarm words for heating current monitoring .....	28
3.7.2	Heating current measured value per output .....	28
3.7.3	Mains voltage measurement and heating current correction .....	28
4	Configuration .....	29
4.1	Device .....	30
4.1.1	General (Allg) .....	31
4.1.1.1	Switching 50/60Hz (FrEq) .....	31
4.1.1.2	Unit .....	31
4.1.1.3	Standard voltage [V] (U.norm) .....	31
4.1.2	Interface (IF) .....	31
4.1.2.1	Type of field bus (Bus.Typ) .....	31
4.1.2.2	Address (Addr) .....	32
4.1.2.3	Fieldbus Baudrate (bAud) .....	32
4.1.2.4	Parity (PrtY) .....	32
4.1.2.5	Modem delay [ms] (C.dEL) .....	32
4.1.2.6	Answer delay [ms] (deLY) .....	32
4.2	Digital inputs (DinP) .....	33
4.2.1	Input module for switching to SP2 (M.SP2) .....	33
4.2.2	Input for switching to SP2 (I.SP2) .....	33
4.2.3	Function of input switching to SP2 (Fn.SP2) .....	33
4.2.4	Forcing input switching to SP2 .....	34
4.3	External TC (ExtTc) .....	35
4.3.1	Internal TC .....	35
4.3.2	External TC via CD vario .....	35
4.3.3	External TC via thermostat .....	35
4.4	Mains voltage compensation .....	35

## Functional-Description CD vario

4.4.1	Input signal of module (InpMod)	36
4.4.2	Input number (InpInd)	36
4.4.3	Sensor type (S.typ)	36
4.4.4	Forcing	36
4.5	Channel data	37
4.5.1	Cycle time for channel 1 (Cycle1)	37
4.5.2	Control behaviour (C.Fnc)	37
4.5.3	Direction of operation (C.Act)	38
4.5.4	Behaviour at sensor break (FAIL)	38
	4.5.4.1 Outputs off	38
	4.5.4.2 Y2 output	38
	4.5.4.3 Mean correcting value	38
4.5.5	Cooling with SP.2 (SP2C)	39
4.5.6	Switching behaviour (CYCL)	39
4.5.7	Loop alarm (LP.AL)	41
4.5.8	Self-tuning	42
	4.5.8.1 General	42
	4.5.8.2 Self-tuning preparation	42
	4.5.8.3 Self-tuning after start-up or at the setpoint	42
	4.5.8.4 Selection of the method	43
	4.5.8.5 Step function at start-up	43
	4.5.8.6 Impulse function at start-up	44
	4.5.8.7 Self-tuning at the setpoint	44
	4.5.8.8 Optimization at the setpoint procedure	45
	4.5.8.9 Self-tuning at the setpoint for 3-point stepping controller	45
	4.5.8.10 Self-tuning start	46
	4.5.8.11 Self-tuning cancelation	46
	4.5.8.12 Causes of cancelation and error messages	47
	4.5.8.13 Examples for self-tuning attempts	47
	4.5.8.14 Manual self-tuning	48
4.5.9	Group self-tuning (AdtG)	49
4.5.10	Tuning of cycle time t1,t2 (Adt0)	51
4.5.11	Auto-tuning mode (Tune)	52
4.5.12	Start of auto-tuning (Strt)	52
4.5.13	Reaction at bus error (B.FAIL)	52
4.5.14	lower control range (rnGl)	53
4.5.15	upper control range (rnGH)	53
4.6	Input (InP)	53
4.6.1	Input signal of module 1 (InpMod)	53
4.6.2	Input 1 (InpInd)	53
4.6.3	Sensor type (S.tYP)	54
4.6.4	Forcing (Forcing)	57
4.6.5	External TC (Ext.TC)	57
4.6.6	Enable measured value correction (X.korr)	57
4.6.7	Logic (LOGI)	58
4.6.8	Set-point (Setp)	59
	4.6.8.1 Setpoint processing (Setp)	59
	4.6.8.2 Type of input signal (TypEing)	60
	4.6.8.3 Signal source channel (ChnSrc)	60
4.6.9	Limit (Lim)	61
	4.6.9.1 Function of limit 1 (Fcn.x)	61
	4.6.9.2 Source of limit (Src.x)	61
5	Parameter	63
5.1	Device	63
	5.1.1 General	63
	5.1.2 External TC	63
	5.1.3 Line conductor 1 (L1)	63
5.2	Channel data	64
	5.2.1 Controller	65
	5.2.1.1 Proportional band	65
	5.2.1.2 Integral action time	66
	5.2.1.3 Derivative action time	66

## Functional-Description CD vario

	5.2.1.4 min. cycle time 1 [s] (t1) .....	66
	5.2.1.5 min. cycle time 2 [s] (t2) .....	66
	5.2.1.6 min. pulse length [s] (tP) .....	66
	5.2.1.7 Puls water cooling [s] (t.on) .....	67
	5.2.1.8 Min. pulse pause [s] (t.off) .....	67
	5.2.1.9 Characteristic watercooling (F.H20) .....	67
	5.2.1.10 Min. temperature [phys] (E.H20) .....	67
	5.2.1.11 Neutral zone/hysteresis [phys] (SH) .....	67
	5.2.1.12 Hysterese Low [phys] (HYS.L) .....	67
	5.2.1.13 Hysterese High [phys] (HYS.H) .....	67
	5.2.1.14 Motor travel time [s] (tt) .....	67
	5.2.1.15 Additional contact [phys] (d.SP) .....	68
	5.2.1.16 Correcting variable 2 [%] (Y2) .....	68
	5.2.1.17 Output limiting .....	68
	5.2.1.18 Lower output range [%] (Y.Lo) .....	68
	5.2.1.19 Upper output range [%] (Y.Hi) .....	68
	5.2.1.20 Working point [%] (Y.0) .....	68
	5.2.1.21 Max. mean value [%] (Ym.H) .....	68
	5.2.1.22 Max. deviation mean [phys] (L.Ym) .....	68
	5.2.1.23 Start-up actuating value [%] (Y.St) .....	69
	5.2.1.24 Factor for pulse height (F.Yop) .....	69
	5.2.1.25 Monitorig time process at rest [min] (T.Pir) .....	69
	5.2.1.26 Pulse attempt (O.Hk) .....	69
5.3	Parameter set 2 .....	70
	5.3.1 Parameter set 2 (PAR2) .....	70
5.4	Inputs .....	70
	5.4.1 lower input value 1 (InL) .....	70
	5.4.2 lower output value 1 (OuL) .....	71
	5.4.3 upper input value 1 (InH) .....	71
	5.4.4 upper output value 1 (OuH) .....	71
	5.4.5 Filter time 1 [s] (tF) .....	71
	5.4.6 Offset of Tk 1 .....	71
5.5	Setpoint .....	71
	5.5.1 lower setpoint range [phys] (SP.LO) .....	71
	5.5.2 upper setpoint range [phys] (SP.Hi) .....	71
	5.5.3 2nd setpoint [phys] (SP.2) .....	72
	5.5.4 Setpoint ramp [/min] (r.SP) .....	72
	5.5.5 Boost increasing [phys] (SP.bo) .....	72
	5.5.6 Boost duration [min] (t.bo) .....	72
	5.5.7 Start-up circuit .....	72
	5.5.8 Setpoint for start-up [phys] (SP.St) .....	72
	5.5.9 Start-up time [min] (t.St) .....	72
5.6	Controlled setpoint tracking .....	73
	5.6.1 Controlled setpoint tracking (Gef) .....	73
	5.6.2 Internal realization .....	73
	5.6.3 Offset of lead setpoint [-] (Gef.Del) .....	75
	5.6.4 Priorities with controlled setpoint tracking .....	75
	5.6.5 Limit (values) (Lim) .....	76
	5.6.5.1 Lower limit 1 [phys] (L1) .....	76
	5.6.5.2 Upper limit 1 [phys] (H1) .....	76
6	Bus data transmission .....	77
	6.1 Single data transmission .....	77
	6.2 Group data transmission .....	78

## 1 Introduction

This manual is a description of the CD VARIO functions and settings accomplished via the "BlueControl" engineering tool.

Due to the overall hardware and software structure and the inherent high flexibility of the CD VARIO system, only configuration and parameter setting via the "BlueControl" engineering tool are purposeful. In this tool, all exclusivities and internal connections are already taken into account, i.e. configuration errors are largely precluded.

Considering the multitude of possible CD VARIO variations and their combinations or interlockings, manual configuration would be too unclear and faulty.

Process-dependent parameters can always be written and read via the field bus.

The allocation principle of inputs and outputs, or of channels and outputs is illustrated at the example of a CD VARIO T4/UTD.

Each channel has virtual inputs and outputs, which can be connected freely with the hardware inputs and outputs, whereby defined (self-evident) limitations must be taken into account: e.g. a built-in (digital) output in the controller cannot be used as a continuous controller output or as an analog process value display. The analog output function is assigned to an additional analog output module. I.e. inputs and outputs of a function, e.g. controller, need not be in the same module. The input and output allocation is not limited to the module.

A virtual output (the software output of a function) can also control several hardware outputs, e.g. (virtual) output 1 of the controller controls 3 SSRs of a three-phase current heating via the 3 outputs of a digital output card.

Before configuration start, the machine requirements must be known exactly:

- Number and type of input signals (thermocouple, Pt100, mV, mA, R...)

- Number and type of controller outputs (switching, continuous...)

- Number and type of alarms (absolute or relative, norm. open/closed contact)

- Number and type of analog outputs (outputs for analog output of measured variables - transmitter function)

### Channel 1

is a three-point controller (heating -> switching, cooling -> switching), with continuous (analog) process value display, 1 alarm contact and loop alarm.

For channel 1, hardware input 1 is the process value input.

The "heating output" is wired to HW output 1.

The "cooling output" is wired to HW output 2.

"Alarm 1" is wired to HW output 7.

The "loop alarm" is wired to HW output 8.

The continuous output for the process value display cannot be realized with the controller module. For this, an extension module with min. one analog output is required, e.g. VARIO AO 1/SF.

### Channel 2

is a "heating controller" with the input value of HW input 3 and the "heating output" is wired to HW output 3.

## Functional-Description CD vario

### Channel 3

is a "heating controller" with the input value of HW input 4 and the "heating output" is wired to HW output 4.

### Channel 4

is a three-point controller (heating -> switching, cooling -> switching) with the process value of input 2. The outputs are wired to HW outputs 5 and 6.

During every-day operation, the above allocation of inputs, channels and outputs is not purposeful. The allocation should be as "straightforward" as possible. The example is intended only for illustration of the possibilities.

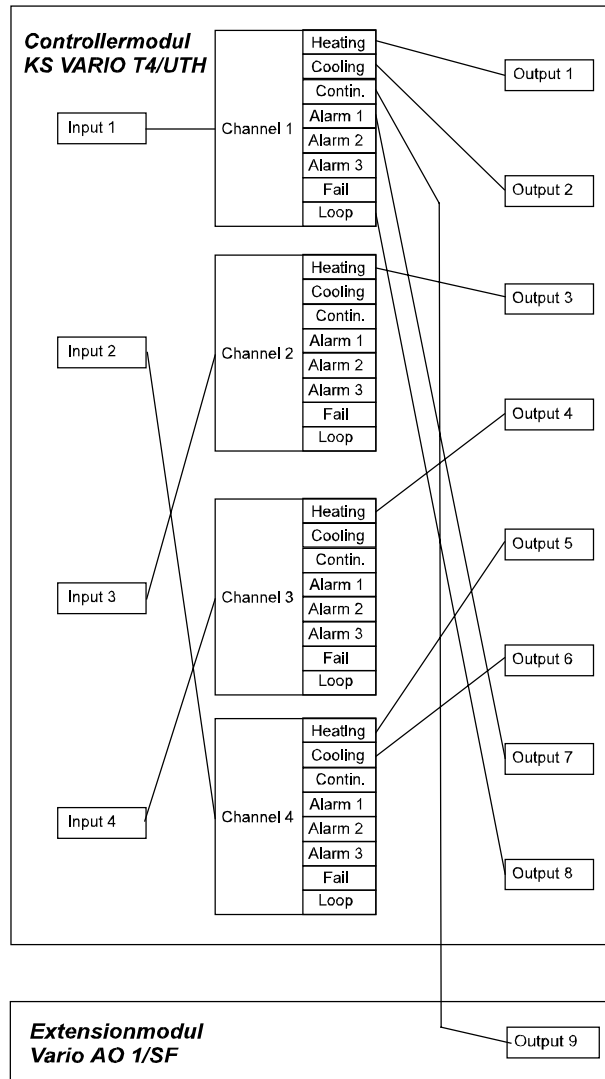

## 2 Creating a project

### 2.1 General information for operation of BlueControl

As already mentioned in the previous section, purposeful configuration of a VARIO station is only possible by means of the BlueControl engineering tool.

The function of CD VARIO modules is explained using the operating pages of the engineering tool.

A CD VARIO station always comprises the bus coupler, which is available for various field bus systems, and a CD VARIO controller module. This controller module must be mounted directly next to the bus coupler. Subsequently, system extension modules can be fitted in any order.

This order should be considered thoroughly in advance, for after project creation, exchanging or shifting of components is not possible any more without revising the complete engineering.

Fields provided for filling in, selection or editing are displayed in yellow.

The default values, which correspond to the module factory setting, are always displayed.

The two types of fields, which can be influenced by the user, are:  
(These two types of fields cannot be distinguished without clicking on them.)

**Selection field:** Clicking on this field will display an arrow on the right. Click on this arrow to open the available selection menu. Double clicking will open the pull-down menu directly. A click on the relevant line will store the value in the line (CD VARIO in this case).

**Input field:** Click in this field to display the input cursor in the default value and the value can be changed. The input limits are specified in the right column *Range*.

### 2.2 Adjusting the start options

For adjusting the start options, open the engineering tool once and call up **Extras** in the header line.

#### 2.2.1 Language

Presently, **Language** permits the selection of four languages:  
German, English, French and Czech.

Changing the language causes a restart of the engineering tool. Any adjustments made so far are lost. The selected language remains unchanged until the language is changed again - also after restart.



2.2.2 Options

In **Options** the engineering tool default settings can be changed.  
The following page is displayed:

Setting	Value
<input type="checkbox"/> General settings	
Program startup	Display selection dialog
<input type="checkbox"/> Device selection	
KS 40-1 universal	<input type="checkbox"/>
KS 40-1 Burner	<input type="checkbox"/>
KS 41-1 universal	<input type="checkbox"/>
KS 42-1 universal	<input type="checkbox"/>
KS 50-1 universal	<input checked="" type="checkbox"/>
KS 50-1 TCont	<input type="checkbox"/>
KS 90-1 advanced	<input type="checkbox"/>
KS 90-1 programmer	<input type="checkbox"/>
KS 90-1 DP	<input type="checkbox"/>
TB 40-1 universal	<input type="checkbox"/>
Digital 280-1	<input type="checkbox"/>
KS 45 rail line	<input type="checkbox"/>
CI 45 rail line	<input type="checkbox"/>
KS 800	<input checked="" type="checkbox"/>
KS 816	<input checked="" type="checkbox"/>
KS 816 (Transmitter)	<input checked="" type="checkbox"/>
KS vario	<input checked="" type="checkbox"/>
<input type="checkbox"/> Windows	
Buttons are used to	Open / activate / close
<input type="checkbox"/> Visible when creating new projects	
Projectinfo	<input type="checkbox"/>
Simulation	<input type="checkbox"/>
<input type="checkbox"/> Visible when opening existing projects	
Projectinfo	<input type="checkbox"/>
Simulation	<input type="checkbox"/>
<input type="checkbox"/> Visible after established connection	
Operation	<input checked="" type="checkbox"/>
Trend	<input type="checkbox"/>
<input type="checkbox"/> Store data to device	
Transfer communication parameters	no
Transfer measured value correction	no
<input type="checkbox"/> Plant simulation	
Extended plant simulation (expert only)	inactive

The settings on this page are dependent on the user's individual practice and without effect on the function of the CD Vario station. Items which were not selected can always be activated later from the running program.

### 2.2.2.1 General settings

**Program startup** permits purposeful start of a project:

**Show empty window** When starting, an empty window without any selection is opened.

**Display selection dialog** Window "Welcome to BlueControl" with the 4 possible options is opened (recommended start menu).

The following four items correspond to the four sub-items of the (self-explaining) selection dialogue:

**Open an existing project**

**Open the last project**

**Create a new project**

**Start project wizard** Presently, this menu item is not available for CD Vario.

### 2.2.2.2 Device selection

In this item, all CDA instruments which can be operated by means of the BlueControl engineering tool are listed. Preselect a series of instruments which will be offered for selection in window **Device selection** -> **basic unit** subsequently when creating a new engineering.

### 2.2.2.3 Windows

**Buttons are used to**

**Open / close** With the window closed, clicking on an icon in the icon bar opens the window. Clicking again closes the window.

**Open / activate** With the window closed, clicking on an icon in the icon bar opens the window. If the window is in the background, it can be activated by a mouse click.

**Open / activate / close** With the window closed, clicking on an icon in the icon bar opens the window. If the window is in the background, it can be activated by a mouse click. When a window is active, it can be closed by mouse clicking.

**Visible when creating new projects** Select, if window **Projectinfo** (for input of information on the project) should be opened automatically and if the **Simulation** should be started automatically when creating new projects.

**Visible when opening existing projects** The signification is the same as above, but when opening existing projects.

**Visible after established connection** Select, if you want to call up **Operation** and/or the **Trend** display automatically after building up a (long-term) connection.

**Store data to device** A safety setting to prevent existing data in the instrument from being overwritten.

**Transfer communication parameters** Transmission of fieldbus parameters (device address !)

**Transfer measured value correction** A measured value correction, which was realized and is only available in the instrument, risks to be overwritten with the default values by downloading of a changed engineering.

## Functional-Description CD vario

### 2.3 Signification of icons



1	Opens a new project.	10	If a permanent connection with the instrument was realized via (15), the operating page can be opened by clicking on this icon.
2	Opens an existing project.	11	This icon starts a menu for data recording.
3	Stores the project handled instantaneously (without safety prompt).	12	Information on the software version of the engineering tool
4	Mails this project as an attachment to an email (the email program is started automatically).	13	Short-term connection with the Vario station for <u>uploading</u> (instrument -> PC) of configuration and parameter setting. The connection exists only during data transmission.
5	Prints the project (den bct file).	14	Short-term connection with the Vario station for <u>downloading</u> (PC -> instrument) of configuration and parameter setting. This connection exists only during data transmission.
6	Opens the page on project information.	15	Long-term connection with the instrument for operation (visualization), data recording. This connection exists until cancelation by the operator by clicking on this icon again.
7	The wiring assistent is opened.	16	Short-term connection with the instrument for read-out of instrument information
8	Opens the configuration and parameter setting pages.	17	Calls up the menu for copying channel data (configuration and parameters).
9	Starts the simulation.		

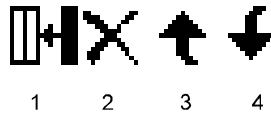

1	Adds the selected module to the station.	3	Shifts the selected module upwards by one position within the station.
2	Removes the selected module from the station.	4	Shifts the selected module downwards by a position within the station.

After opening the engineering tool, the following page is displayed.

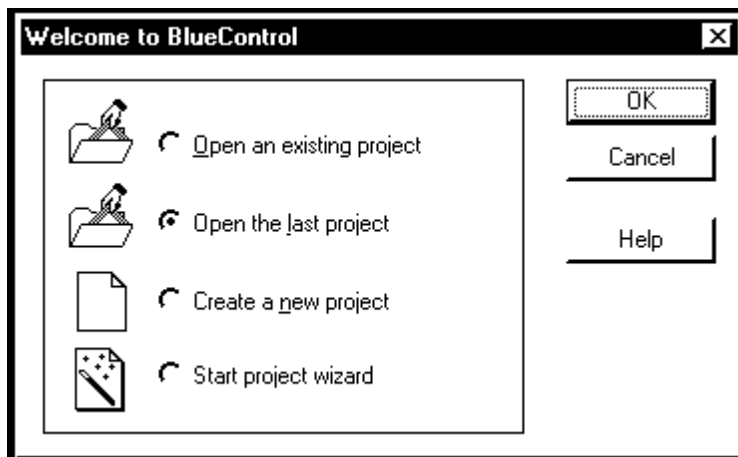

**2.3.1 Open an existing project**

A window to search for a defined project is opened. BlueControl projects always have the extension **bct**. The adjustments on page **Device selection** correspond to those of the open project. The adjustments can be changed.

**2.3.2 Open the last project**

The project handled (and closed) last is opened. The adjustments on page **Device selection** correspond to those of the open project. The adjustments can be changed.

**2.3.3 Generate a new project**

The input of a new project is prepared and window **Device selection** is displayed. With a new project, the window is opened with the setting with which it was closed when opened last. The adjustments can be changed.

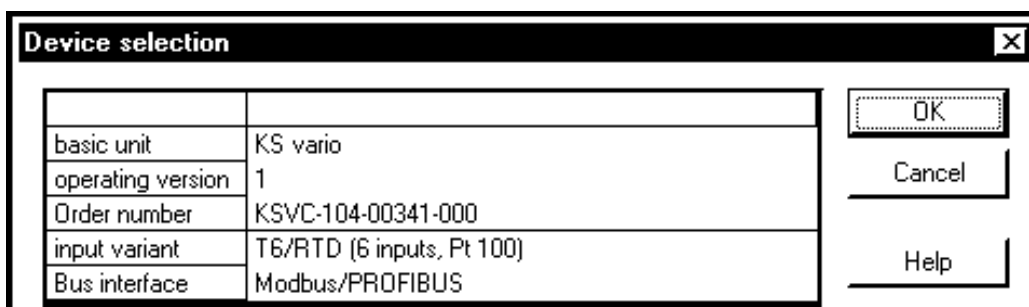

As the BlueControl engineering tool can be used for several CDA instrument series, selection (CD VARIO in this case) must be made in line **basic unit**. (The other instruments are not described in this manual.)

## Functional-Description CD vario

---

In line **input variant**, the following controller modules are available (i.e. the controller module variants):

T4/UTH (4 inputs, thermocouple)  
T4/RTD (4 inputs, Pt100)  
T8/UTH (8 inputs, thermocouple)  
T6/RTD (6 inputs, Pt100)

In line **Bus interface**, the field bus must be selected:

Modbus/PROFIBUS  
CANopen  
Interbus/Ethernet

Selection of an instrument type displays the relevant order number in line **Order number**.

After closing window **Device selection** (if configured in **Extras -> Options**), window **Project info - Device x** is displayed. On this page, project information can be entered.

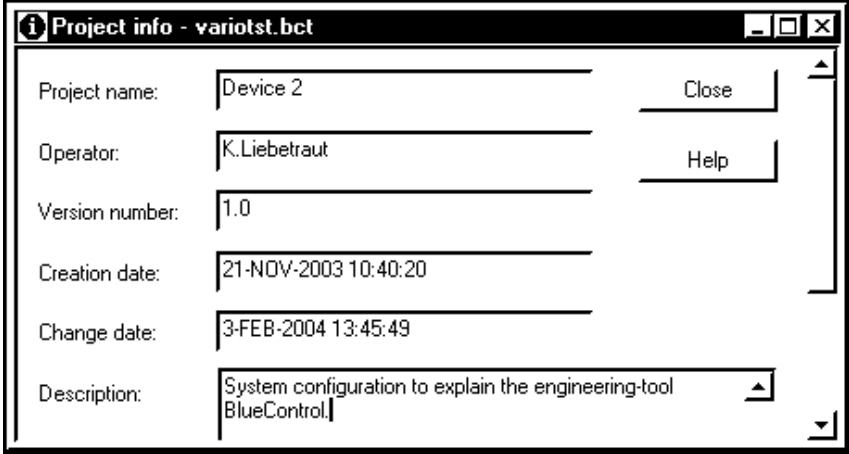

The screenshot shows a window titled "Project info - variotst.bct" with the following fields and values:

Project name:	Device 2	Close
Operator:	K.Liebetaut	Help
Version number:	1.0	
Creation date:	21-NOV-2003 10:40:20	
Change date:	3-FEB-2004 13:45:49	
Description:	System configuration to explain the engineering-tool BlueControl	

### 3 Connection wizard

#### 3.1 System configuration

The window displayed next is **System configuration**. This window is used to compose the other modules required by the system. Position "0" will always be filled automatically with the controller module selected in **Device selection**. This module is the "master" of the VARIO station. The complete communication via field bus, controller operation, input and output management, alarms is via this controller module. The other modules are only "extension modules" and unable to function independently.

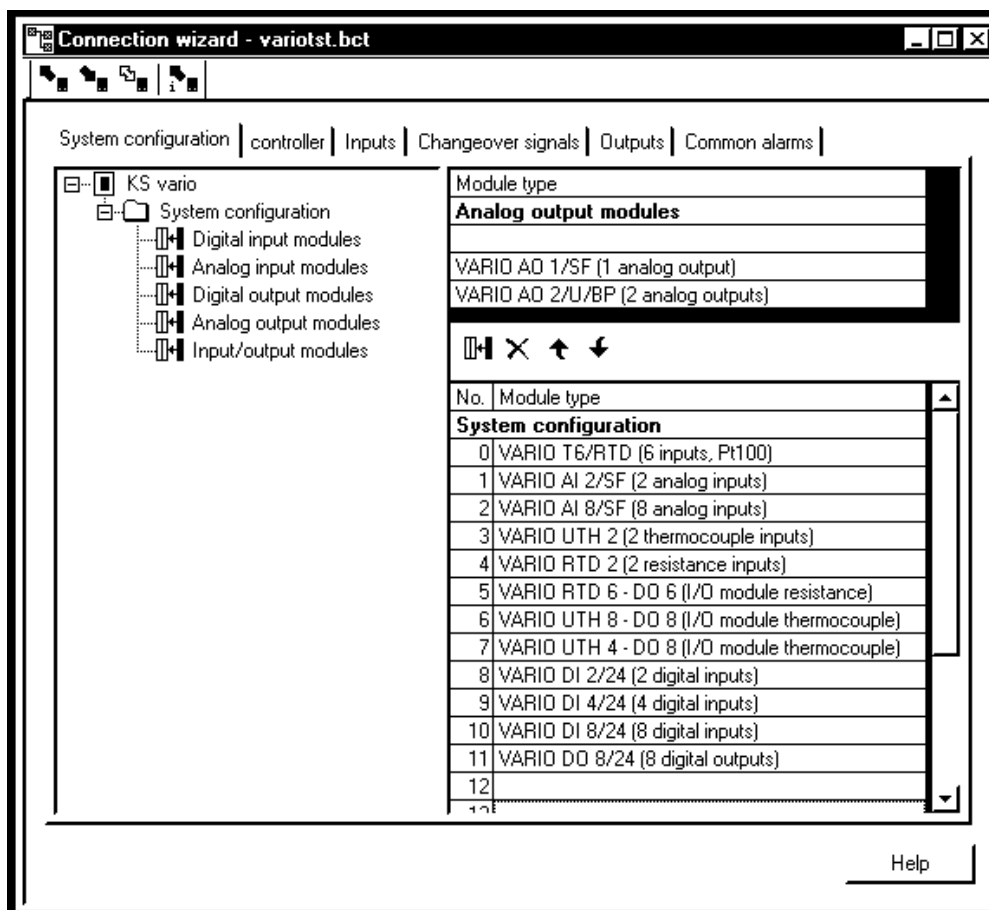

The various types of system components are listed on the left, whilst the variants provided are given at the top right.

#### Digital input modules

- VARIO DI 2/24 (2 digital inputs)
- VARIO DI 4/24 (4 digital inputs)
- VARIO DI 8/24 (8 digital inputs)

#### Analog input modules

- VARIO AI 2/SF (2 analog inputs)
- VARIO AI 8/SF (8 analog inputs)
- VARIO UTH 2 (2 thermocouple inputs)
- VARIO RTD 2 (2 resistance inputs)

### Digital output modules

VARIO DO 2/24 (2 digital outputs)  
VARIO DO 4/24 (4 digital outputs)  
VARIO DO 8/24 (8 digital outputs)  
VARIO DO 16/24 (16 digital outputs)

### Analog output modules

VARIO AO 1/SF (1 analog output)  
VARIO AO 2/SF (2 analog output)

### Input/output modules

VARIO RTD6 DO 6 (I/O module, Resistance)  
VARIO UTH8 DO 8 (I/O module, Thermocouple)  
VARIO UTH4 DO 8 (I/O module thermocouple)

Click on one of these (left) groups to display the versions of this group in the top right window. A module can be selected and added to the system by clicking on icon **Add** (1) (bottom right in the window).

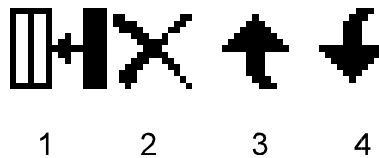

A module displayed in the bottom right section of the monitor can be selected for handling by clicking:

**Remove** (2) removes the module from the system.

**Shift up** (3) shifts the module upwards by one position within the system.

**Shift down** (4) shifts the module downwards by one position within the system.

Before leaving the system configuration, this window offers the last opportunity to change the system composition without changing or recreating the complete engineering.

## Functional-Description CD vario

### 3.1.1 VARIO module current consumption

VARIO module current consumption (for typical values, detailed specifications, see also module-specific data sheets)

Type	Order no.	Width [mm]	I of UB [mA]	I of UI [mA]	I of Uana [mA]	I of Us max [mA]
VARIO BK DP/V1	KSVC-101-00011	86 mm	115	--	--	--
VARIO T8/UTH	KSVC-104-00441	4		120	30	600
VARIO UTH 8/DO8	KSVC-103-00441	4		120	30	600
VARIO UTH4/DO8	KSVC-103-00431	4		120	30	600
VARIO RTD 6-DO6	KSVC-103-00341	4		120	30	450
VARIO AI 2/SF	KSVC-103-00121	1		45	12	
VARIO AI 8/SF	KSVC-103-00141	4		50	30	
VARIO RTD 2	KSVC-103-00321	1		45	11	
VARIO UTH 2	KSVC-103-00421	1		45	11	
VARIO AO1 /SF	KSVC-103-00211	2		30	50	
VARIO AO 2/U/BP	KSVC-103-00221	1		33	25	
VARIO DI 2/24	KSVC-102-00141	4		35		500
VARIO DI 4/24	KSVC-102-00141	4		40		1000
VARIO DI 8/24	KSVC-102-00141	4		50		2000
VARIO DO 2/24	KSVC-102-00221	4		33		1000
VARIO DO 4/24	KSVC-102-00231	4		44		2000
VARIO DO 8/24	KSVC-102-00241	4		60		4000
VARIO DO 16/24	KSVC-102-00251	4		90		8000
VARIO DO 1/230	KSVC-102-002x1	4		60		Relay

The modules within a system can be fitted in any position. Only the controller module (no.0) is fixed and cannot be shifted or deleted.

As the supply voltage is provided by the bus coupler, note that modules with high current requirement (e.g. digital output modules with 8 outputs with high load) are fitted in a low position (voltage drop on the internal supply) when mounting. See also the table above.



**System example**

The system example comprises:

- 8 control loops for thermocouple,
- 2 control loops for resistance thermometer,
- 8 digital outputs for the resistance thermometer controller and group alarm outputs
- 8 digital inputs for external controller operation
- 8 analog inputs for heating current monitoring

**Caution! Heating current monitoring is possible only via controller module (no.0) or via additional input/output modules.**

Although the analog input/output modules can also be used as inputs/outputs for controllers, these modules do not provide heating current measurement. (Control is in the controller module and output of the correcting variable or of alarms is via analog/digital output modules). If heating current measurement is also required for these channels, corresponding input/output modules (VARIO RTD6 DO6, VARIO UTH8 DO8, UTH4 DO8) must be used. Control excepted, the function of these modules is identical with a controller module.

**3.2 Controller**

Completion of the system configuration is followed by the distribution of available calculation time to the controller channels (max. 30 controller channels are possible).

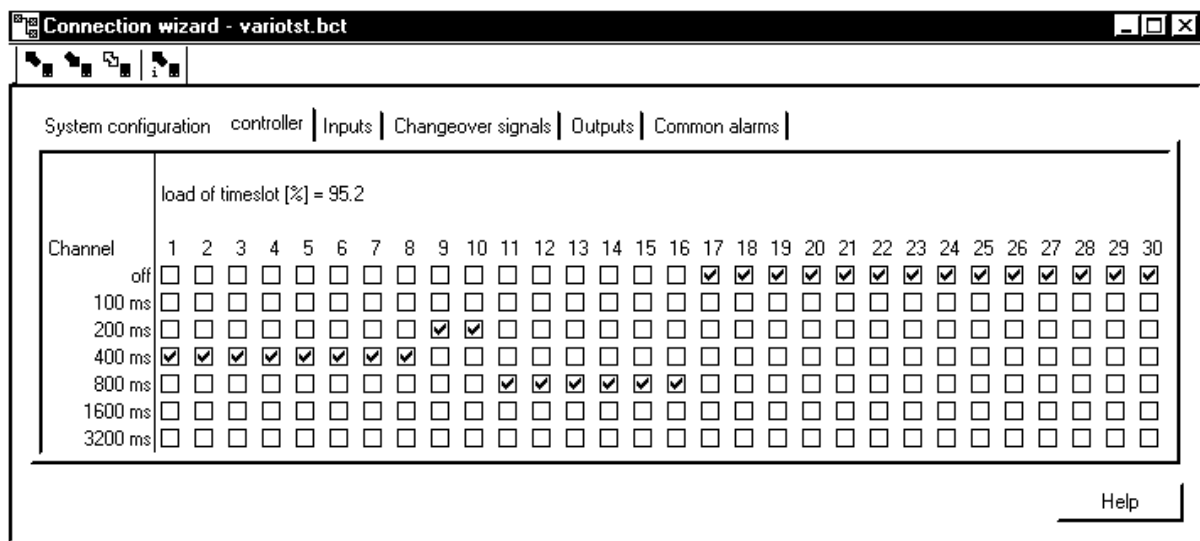

Distribution is according to the following principle:

A controller which is calculated at intervals of 3200 ms "consumes" 0,8% of the microprocessor calculating capacity. For handling the same controller at intervals of 1600 ms, the required calculation capacity is twice as high, etc. up to a scanning interval of 100 ms with a load of 25,6% per channel.

Click in the relevant checkbox (controller number and required scanning interval) to display the processor load in the uppermost line. If this load exceeds 100% and still not

all controllers are included, the scanning interval must be extended for one or several controllers.

**Caution! If the system configuration is changed subsequently by adding or removing (controller) modules, the distribution made on this page is not displayed on the other pages not realized in the system. This must be done manually.**

In position **off**, the controller is switched off completely: the input is not measured, alarms are not active and the output goes to 0% duty cycle, or 0/4 mA.

### 3.3 Inputs

The inputs are not firmly allocated to the channels with the same description. Allocation is completely free and not limited to the module. For clarity, however, 1:1 allocation is preferable (as shown in the figure).

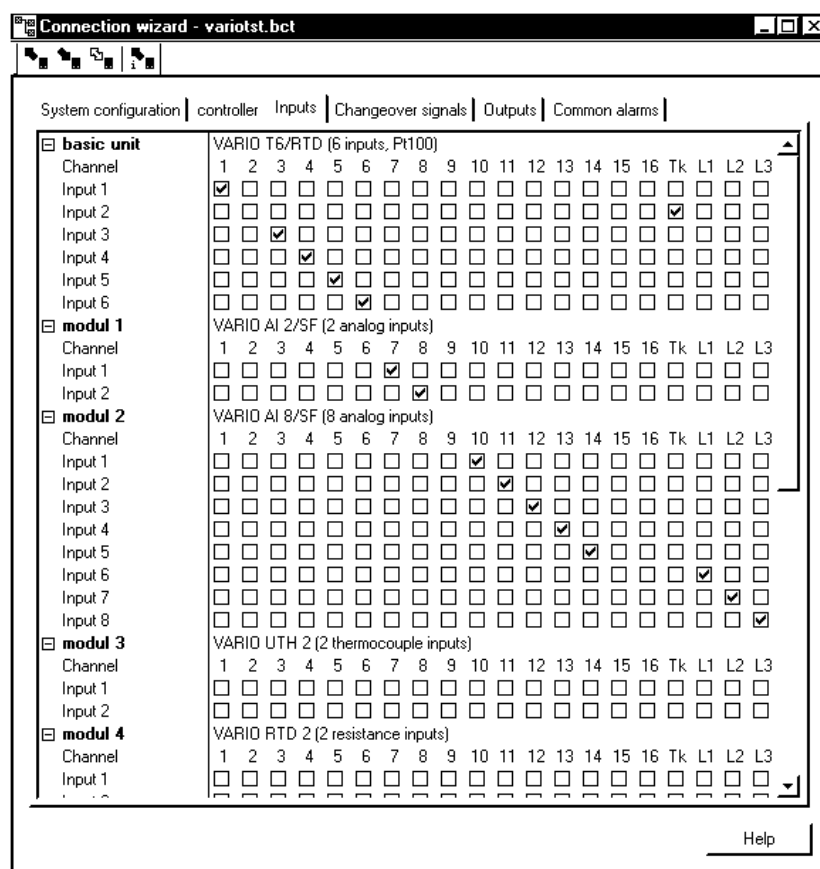

#### 3.3.1 Input allocation

Allocation of inputs and channels is on screen page **Inputs**. In controller module 0, the 8 thermocouple inputs are distributed to the 8 channels. The Pt100 inputs of module 2 are assigned to controller channels 9 and 10. Analog inputs 1, 2 and 3 of module 4 are used for mains voltage measurement for correction of the heating current measured value (L1, L2 and L3).

Column **Tk** is not used in this example. The column permits allocation of an input for temperature measurement to the (external) temperature compensation.  
 The inputs can also be configured at this point: double click on the relevant input to open the same window as under "Configuration -> Channel data -> Input."

### 3.3.1.1 Unused inputs

Unused individual input module channels must be treated as follows:

Thermocouples:	short circuit
Voltage:	short circuit
Current:	open
Heating current:	open
Resistance thermometer:	terminate with a resistor in the selected measuring range

### 3.4 Changeover signals

Allocation of digital inputs and controller operating functions is on page **Changeover signals**. These functions are:

- W2** activating the 2nd set-point
- Par2** activating the 2nd parameter set
- Coff** controller switch-off (only the controller output is switched off, all other functions, alarms, sensor error... continue operating).
- Boost** the boost function is activated with the adjusted parameters
- Man** the controller is switched over to manual operation

**Caution! Which controller channel should be operated via a digital input remains to be determined in the parameter setting module.**

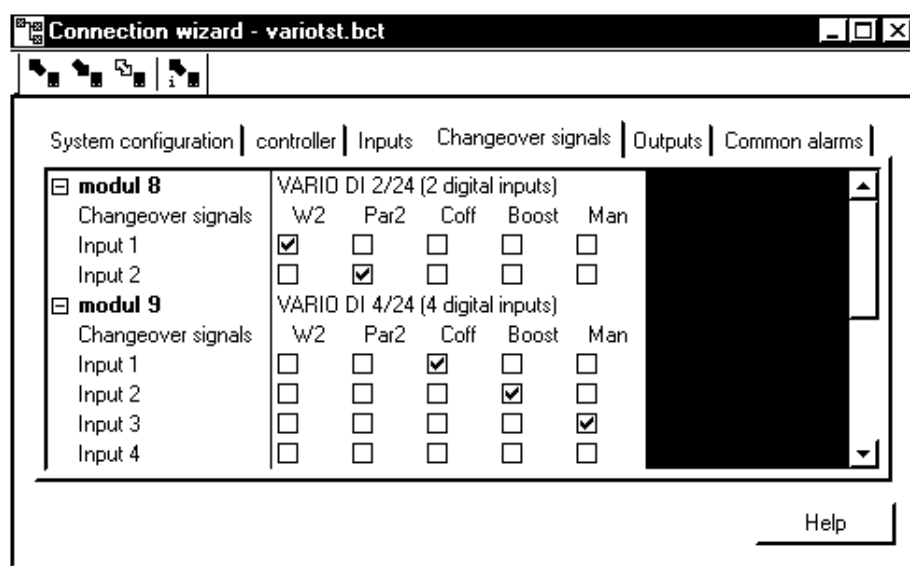

## Functional-Description CD vario

---

The function is active, when applying a signal according to the digital input configuration - active-high, active-low or push-button to the relevant input, or when the changeover function is switched on via the bus. An active digital control input has priority over changeover via the bus. With the digital input inactive, switch-over via the bus is possible.

Unused inputs of a digital input module can remain open.

Activating a controller operating function from different inputs of digital input modules is not possible.

Starting several controller operating functions is possible via a digital input, or several digital inputs can be activated simultaneously.

Controller operation acts internally on two different function blocks with different priorities:

Coff, Man and Par2 act  
on the controller function

W2 and Boost act  
on the setpoint processing

Controller function	
Function	Priority
Coff	1
Man	2
Par2	without <sup>1)</sup>

Set-point processing	
Function	Priority
W2	1
Boost	2 <sup>2)</sup>

<sup>1)</sup> With the controller switched off or switched to the manual mode, parameter switch-over is without effect. If Coff and Man are reset (and Par2 remains switched on), the controller operates with parameter set 2.

<sup>2)</sup> Although the boost function is a set-point increase, it is effective only with W (set-point 1) active.

### 3.5 Outputs

Like the inputs, the channel numbers are not firmly allocated to the output numbers.

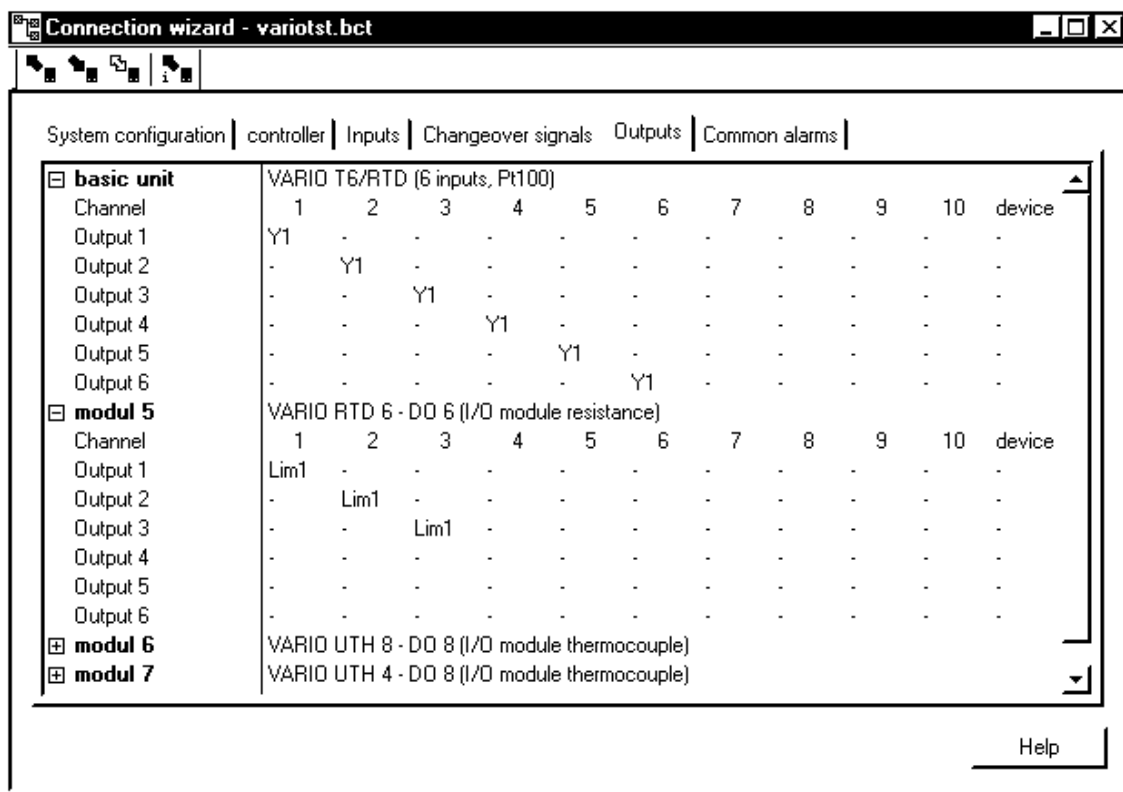

Any allocation of (virtual) controller outputs is possible, and not limited within a module. For instance, the 16 outputs of 8 three-point controllers (heating/cooling) can be allocated to a 16-channel digital output module, whilst the 8 outputs of the controller module itself are used as alarm outputs.

Double click on an output field to display a pull-down menu with the possibilities to allocate this output.

- Y1** (correcting variable Y1)
- Y2** (correcting variable Y2, only with three-point or three-point stepping controllers)
- Lim1** (limit value signal 1)
- Lim2** (limit value signal 2)
- Lim3** (limit value signal 3)
- Loop** (control loop alarm)

In the (right) column **device**, a pull-down menu with **LimGr1** to **LimGr6** and **forcing** is displayed.

**LimGrx** are the alarm messages determined on page **group alarms**.

Like with the inputs, the output configuration is also determined by double clicking.

### 3.6 Group alarms

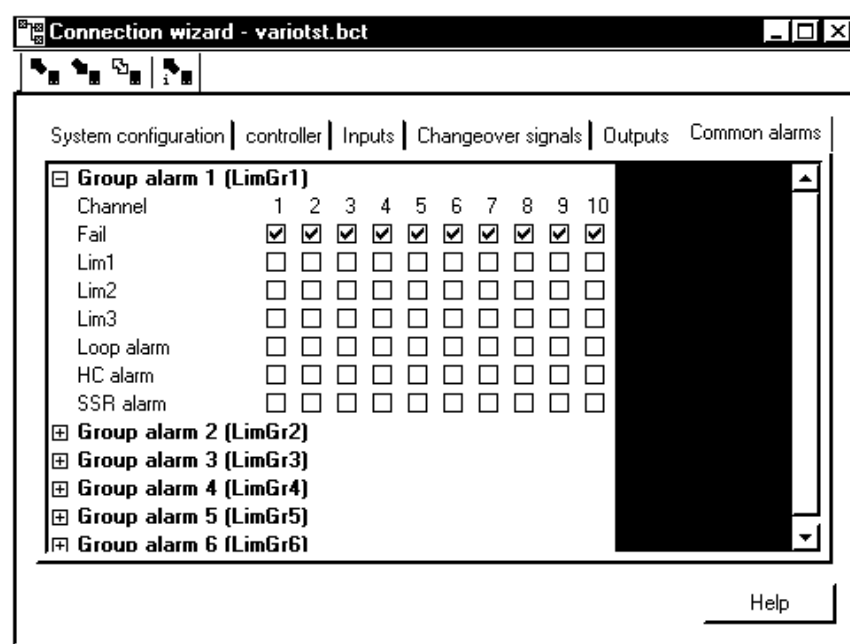

Each CD VARIO station is provided with 6 group alarms, which can be allocated to 7 different alarms.

Group alarms are OR functions of alarms which can also be of different type. A group alarm can have max. 32 alarm functions.

#### 3.6.1 Fail (alarms)

are alarm messages which relate to the module inputs. Signalling is provided for:

**Thermocouple:** out-of-limits, sensor break, interruption, wrong polarity (if the sensor temperature is by 30K lower than the thermocouple span start).

**Resistance thermometer:** out-of-limits, interruption, short circuit

**Standard signal, unipolar:** span end exceeded

**Standard signal, bipolar:** out-of-limits (span end exceeded, span start exceeded)

**Standard signal 4...20 mA:** out-of-limits (span end exceeded, span start exceeded (<3,2 mA), lead break

#### 3.6.2 Lim1, Lim2, Lim3

are limit alarms. Absolute alarm or relative alarm, above or below the set-point. Detailed specification is in **Parameters -> Limits**.

### 3.6.3 Loop alarm

(Control loop monitoring) The control loop monitoring can be activated individually for each controller, whereby the overall control loop - comprising sensor, controller, switching element, (power) fuse, heating, or cooling and all cables - is monitored.

The monitoring principle is that the process value must increase with 100% output signal: with 100% correcting variable, the process value must change by min. 1% of the set-point adjustment range ( $W_{100} - W_0$ ) during a time of  $2 \cdot T_{n1}$ . As this method uses the integral action time ( $T_n$ ), it can be used only for controllers with I action (99,5% of all applications).

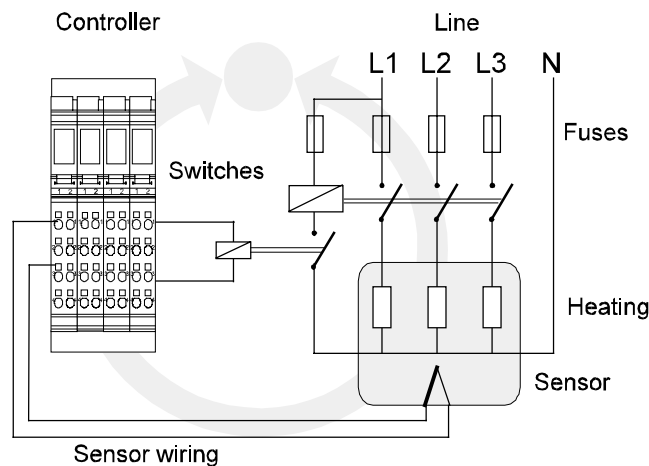

**Monitoring is provided for virtually all faults which may occur in a control loop:**

- sensor short circuit,
- wrong sensor polarity,
- sensor is without thermal contact with the heating,
- sensor break (is monitored additionally by the sensor alarm),
- lead break,
- failure of the controller (rather than of the alarm setting),
- failure of the switching element,
- failure of the fuse or of the (power) energy.

**Once switched on, this monitoring is active continuously.**

#### Control loop ok:

- Starting up the cold machine: duty cycle = 100% -> the temperature increases;
- Temperature reached -> duty cycle <100% -> monitoring is in stand-by;
- Set-point increase -> X-W increases -> duty cycle = 100% -> temperature increases.

**Caution !!! With slow processes, a loop alarm may be generated when switching on the machine/system, because the temperature increase is smaller than the preset loop alarm values. However, this alarm will disappear automatically, when the temperature increase is sufficient, or the correcting variable is more than 5 % below the maximum value.**

### Fault in the control loop:

If there is a fault anywhere in the control loop, the temperature decreases, although the control deviation ( $X_w$ ) and thus output variable  $Y_1$  increases. When  $Y_1$  has reached 100%, measurement if the temperature changes in the required direction during  $2 \cdot T_{n1}$  is done. Unless this is the case, a control loop alarm is triggered. Alarm signalling is with a delay of  $2 \cdot T_n$  at the earliest.

The above example refers to inverse controllers ; it is also applicable to direct controllers analogously .

The loop alarm is reset automatically, when the correcting variable decreases by 5% below the maximum value (normally to 95%) and the temperature increases by min. 1 % during time  $2 \cdot T_{n1}$ . (1% of the selected sensor span start). Manual reset is also possible by switching the controller(s) off and on again.

If the error is still pending when switching on the controller again, the loop alarm is output again after  $2 \cdot T_{n1}$ .

The loop alarm is not possible with:

Signallers (there is neither a correcting variable which can increase to 100%, nor an integral action time.)

Three-point stepping controllers (only the changes of the correcting variable rather than the complete correcting variable are output, positioning pulses.)



3.7 HC alarm (heating current monitoring)

The heating current monitoring function in CD VARIO can be used for monitoring 8 outputs (or 6 outputs with the RTD controller version) by means of one current transformer. The relevant total current input is provided both on controller modules and I/O extension modules. A VARIO station can handle max. 6 "heating current groups" from various current transformers, i.e. in addition to the CD VARIO controller module, 5 I/O modules with an own heating current input can be connected.

Due to the system flexibility, various current measurement groups can be realized: if the differences between the current consumption of the individual zones are significant to an extent that purposeful evaluation is not possible, the zones with low current consumption can be grouped in one module, i.e. in one current transformer. The heatings with the next higher "current group" are classified in the next module, etc.

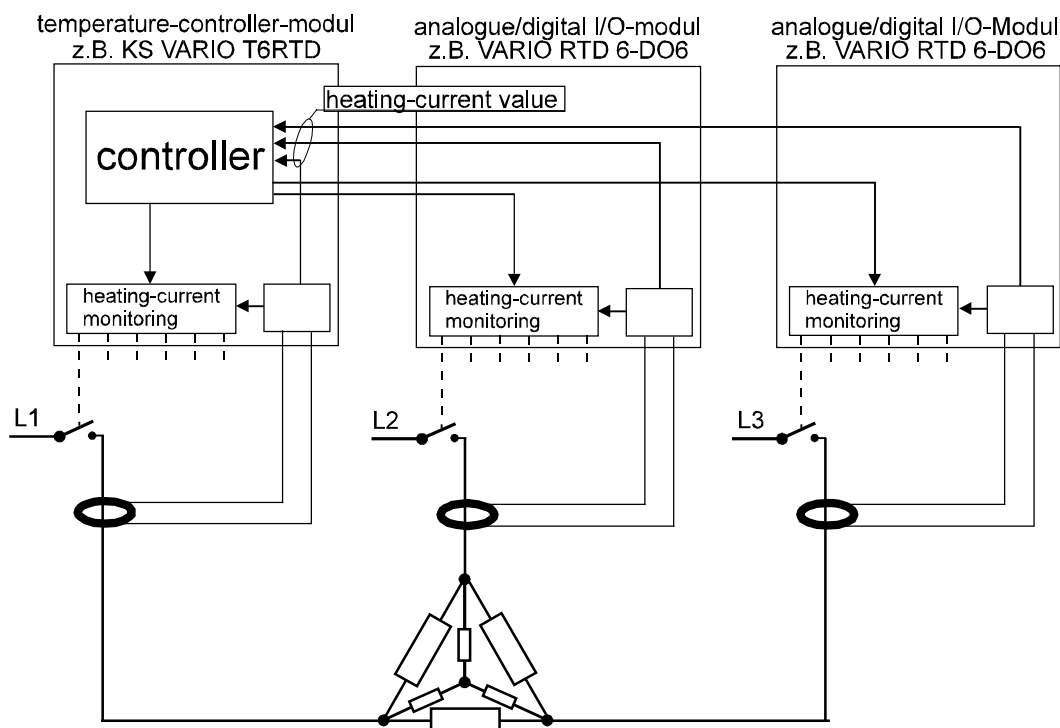

If a controller output is distributed to several (hardware) outputs of various modules, synchronous switching of related outputs is ensured, because output operation is done centrally by the controller (module).

Nevertheless, heating current measurement is not synchronous, because the operation of heating current measurement is separate in each module. For this reason, heating current measurement of a three-phase current load without neutral wire (N) is not possible. In this case, the (three-phase current) load must be switched via **one** output (using 3 power switches) and a three-phase transformer.

Heating current checking can be done at an adjustable interval. Independent of the control, all outputs configured accordingly, the one to be checked excepted, are switched off and the heating current is measured. It must be higher than the value specified in **HC.Lim**, otherwise, there is an interruption, i.e. a corresponding error message is output.

Checking for overload (if configured) means checking if the current is higher than the value specified in **HC.Lim**.

Heating current monitoring is followed by checking of the motor actuator for short circuit (contact welding or SSR fault): for this, all controller outputs are switched off and the measured current must be lower than:

$I = 3\%$  of the value specified in ??? "Heating current span end". An exceeded heating current span end??? is due to actuator short circuit.

Only the lines the zone of which is configured for heating current monitoring may be taken through the transformer, because **non-configured** outputs are not switched off, i.e. the (continuous) current would cause measurement errors.

Evaluation is controller-specific and must be adjusted for each controller.

In the **Connection wizard**  $\Rightarrow$  **Outputs**, the configurations can be determined after mouse clicking on the relevant output:

### **HC.AIMode:**

Define, if checking for heating current overload or heating loop interruption is required.

There are three modes of heating current monitoring:

1. Monitoring switched off
2. Monitoring for **low current** and actuator short circuit
3. Monitoring of **exceeded current** and actuator short circuit

### **Tr.Rat:**

For heating current display with correct scaling (e.g. in A) in **HC.Me** the transformation ratio of the connected current transformer must be adjusted.

**Example:** The transformation ratio of the transformer is 1000:1. Adjust 1000 in **Tr.Rat**. With input current 50 mA/AC fed into the heating current input, a heating current measured value **HC.Me:** of 50,0 A is displayed.

### **HC.Lim:**

Enter the heating current limit value (in A). Unless the heating current limit (HC.Lim) is switched on [on], heating current measurement and monitoring are omitted.

After activating the heating current measurement, determination how frequently the heating current should be measured and for how long the relevant output should be switched on before the measurement can be determined in parameter menu (**HC monitoring**  $\Rightarrow$  **HC basic unit**). These settings can be done separately for each HC input.

### **HC.Cy:** Cycle time for heat current check [sec]

For monitoring, measurement is at intervals of the adjusted number of seconds. This means that each channel is measured after number of channels + 1 (for short circuit measurement) multiplied by the cycle time.

This time should not be too short, because a heating is a relatively insensitive product, which does not require frequent checking, and because the control quality can be impaired by switching off the other heating circuits during measurement, especially with fast processes.

**HC.Ti** Switch-on cycle for heat current check [100 ms]

This is the time during which the outputs to be checked are energized prior to the measurement for heating circuit monitoring (signal settlement). Smallest value for the switch-on cycle (incl. measurement): 200 ms

The value is dependent on:

1. the type of switching element. With contactors, especially power contactors, the switching time (response time) is longer, i.e. the value must be higher. For solid-state relays, this value is negligible.
2. the current converter settling time. Converters with built-in transmitter require more time, until the measured value at the output has settled.

The actual heating currents are **output** via:

**HC.Me:**

This process datum is controller channel related (1...30). Independent on the output wiring, this datum relates to the control channel. I.e., with several outputs connected to a channel, several heating current monitorings are active for a controller channel and the heating current measurement total is output.

The heating current alarm is a group alarm and allocated to the instrument.

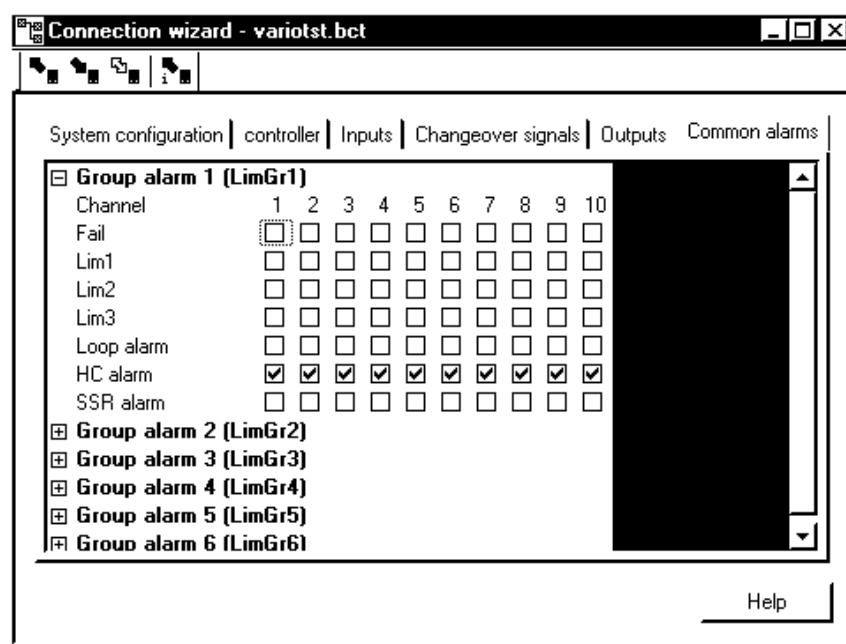

In the example shown above, all 6 heating current alarms are classified in group alarm 6 (LimGr6). This signal is allocated to hardware output 1 of digital output module 11 on page **Outputs**.

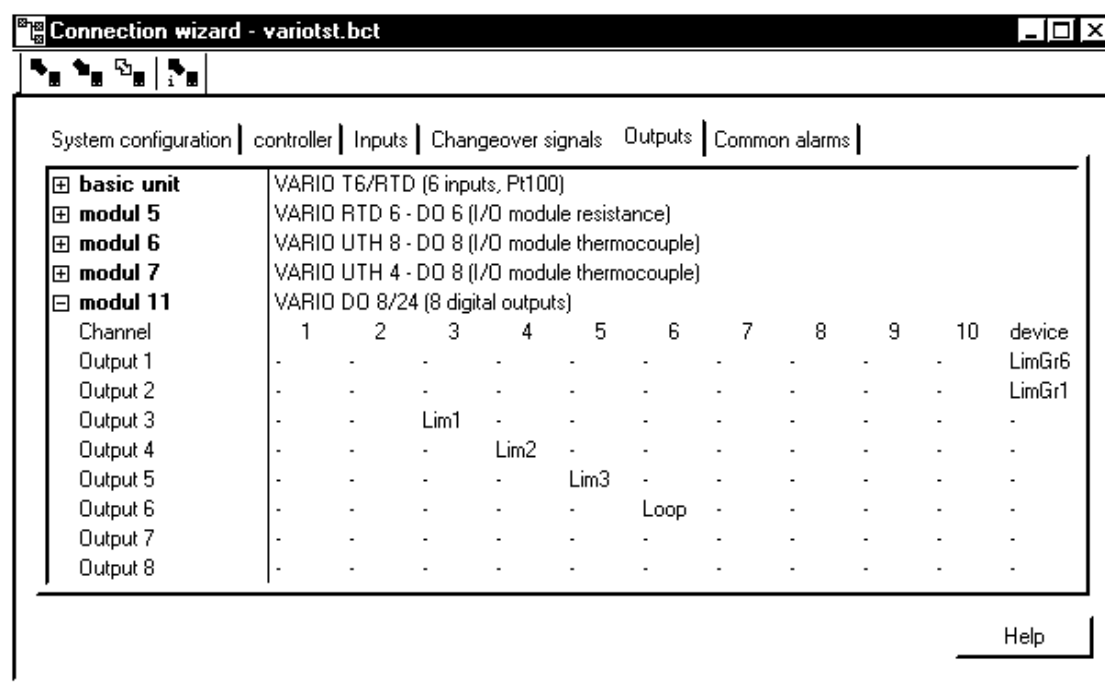

### 3.7.1 Control/alarm words for heating current monitoring

#### S.AlaX:

In this alarm status, all alarms are classified in groups of 2 channels, e.g. heating current alarm and SSR alarm (short circuit). The 30 data S.AlaX are in "Operation".

#### Hc.Status:

These 60 data refer to the outputs (1...60). 2 of these data at a time are in the „channel part“ of the Modbus directory. Signalling is provided for HC alarm and SSR alarm.

### 3.7.2 Heating current measured value per output

#### Hc.Value:

As opposed to process datum „HC.ME“, the heating current switched via the **relevant output** is stored in this item. To conclude which control channel was concerned the information which outputs are wired to which controller is needed. 2 of these data at a time are in the „channel part“ of the Modbus directory.

### 3.7.3 Mains voltage measurement and heating current correction

One of the analog input modules (range: 0...10V) can be used to measure one or all 3 phases (3 x converter modules) by means of a voltage converter (order no. KSVC-109-30001). By means of scaling, the displayed value is related to the mains voltage:

**Example:** The voltage converter module outputs 7 V DC at an input voltage of 230 V AC. The following values are adjusted for the input scaling:

**InLP1: 0**  
**Ou.LP1: 0**  
**InHP1: 7**  
**Ou.LP2: 230**

## Functional-Description CD vario

---

Name	Description	Value	on	Range
<b>L1</b>	<b>line conductor 1</b>			
InLP1	lower input value [phys]	207.0		-3000...3200
OuLP1	lower output value [phys]	7.200	<input checked="" type="checkbox"/>	-3000...3200
InHP1	upper input value [phys]	253.0		-3000...3200
OuHP1	upper output value [phys]	8.800		-3000...3200

The current process values are corrected according to mains voltage value ***U.norm*** which must be adjusted in the controller. Consequently, the normal heating current variations occurring with voltage variations are eliminated.

### ***SSR alarm***

This alarm is the output of an error message, which is determined by means of heating current monitoring. In a heating current monitoring phase, all outputs are switched off, i.e. no (heating) current flow is allowed. Heating current flow despite switched off outputs is due to a short circuit of the switching element.

## 4 Configuration

In the header line, a selection window for configuration and parameter setting of the station or selection of the data to be transmitted via the PROFIBUS can be opened.

Up to this point, the description deals mainly with the creation of the "inner wiring" of the VARIO station, i.e. the allocation of inputs and output to the channels.

During configuration, the type of inputs and outputs, e.g. sensor type, output action, behaviour with sensor failure, etc. are defined.

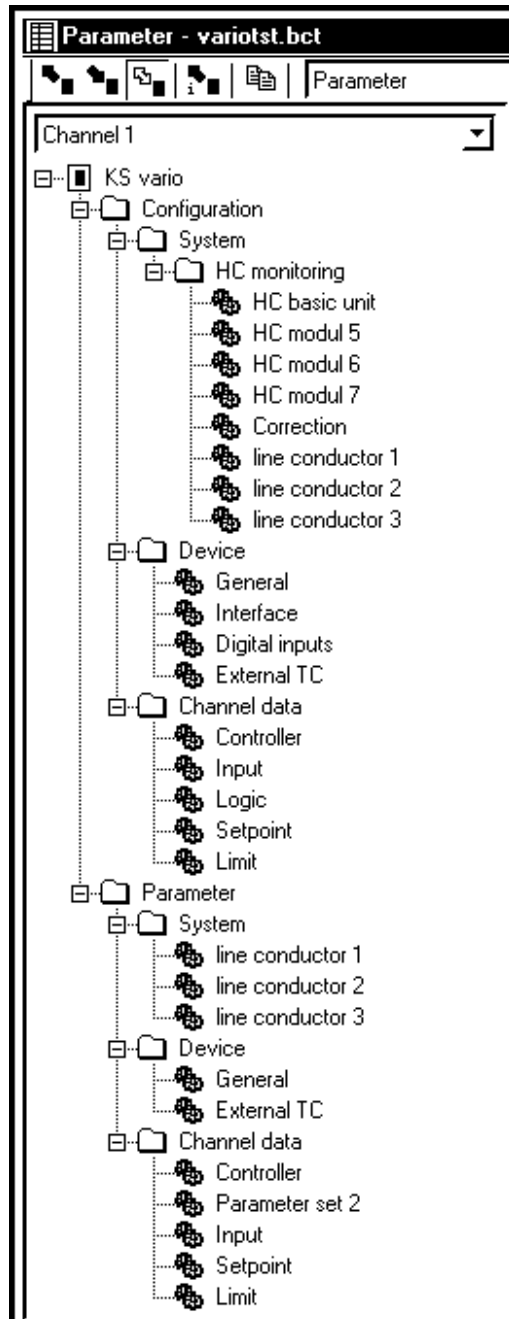

The structure of this page corresponds to the structure of the Windows Explorer.

## 4.1 Device

The settings made in menu item *Device* are valid for a complete VARIO station.

### 4.1.1 General (Allg)

Name	Description	Value
<b>Allg</b>	<b>General</b>	
<b>393x86</b>		
FrEq	switching 50/60 Hz	0: mains frequency 50 Hz
Unit	unit	1: in Celsius

#### 4.1.1.1 Switching 50/60Hz (FrEq)

serves to adapt the software filter in the input of each channel for suppression of interference on lines.

#### 4.1.1.2 Unit

Selection of °C, °F and without unit is possible. The process values are converted automatically when changing the unit. All other values (set-points, limit values...) must be converted manually.

#### 4.1.1.3 Standard voltage [V] (U.norm)

When measuring the heating current, measurement error and thus faulty alarms may occur, if the mains voltage is too low, especially, if the current limit values are very close to the nominal current value.

In this line, you can activate the mains voltage correction and determine the "standard voltage" simultaneously. A separate voltage transformer transforms the mains voltage into a constant voltage with a 100% value of 7V DC. Fill in the nominal value of the mains voltage which shall produce these 7V DC (normally 230V). Any mains voltage variation generates a secondary voltage  $\neq$  7V. This value is used for correction of the current value.

### 4.1.2 Interface (IF)

Name	Description	Value	Range
<b>IF</b>	<b>Interface</b>		
Bus.Typ	type of field bus	0: Modbus	
Addr	address	1	1...247
bAud	baudrate	2: 9600 bits/s	
PrtY	parity	1: even parity	
C.dEL	modem delay [ms]	0	0...200
dELY	answer delay [ms]	0	0...200

#### 4.1.2.1 Type of field bus (Bus.Typ)

Select the field bus to which the CD VARIO station is connected.  
Presently available: PROFIBUS and Modbus

### 4.1.2.2 Address (Addr)

Field for entry of the address of the relevant CD VARIO station.

With Profibus bus couplers, addressing can be done via switches, fieldbus or engineering tool. Priority is given to the switch setting. Adjustment via the bus is possible only with the switches set to "00".

address 10s



address 1s



With Modbus bus couplers, the address setting is only possible via engineering tool or fieldbus.

### 4.1.2.3 Fieldbus Baudrate (bAud)

Select the Baudrate used in the field bus. For PROFIBUS, no Baudrate needs being selected, adaptation is automatic. The following Baudrates are available for the field bus:

2400  
4800  
9600  
19200  
38400

### 4.1.2.4 Parity (PrtY)

Select the parity used in the field bus: even or odd.

### 4.1.2.5 Modem delay [ms] (C.dEL)

During transmission via the Modbus, a message is considered as complete, if there is a gap >1,5 bytes. With some modems, however, there may be longer gaps within a message (due to internal modem checkings). In order not to consider these gaps as "message end", detection of the "message end" can be delayed up to 200ms. The value which must be adjusted depends on the modem used.

### 4.1.2.6 Answer delay [ms] (deLY)

Adjust the delay time between message receiving and message sending (answering). Adjustable within 0 and 200ms.



## 4.2 Digital inputs (DinP)

On this page, the digital inputs (of the digital input module) are allocated to the external operating functions of the controller module. There are 5 blocks, which correspond to the controller operating functions:

Name	Description	Value
<b>DInP</b>	<b>Digital inputs</b>	
M.SP2	input module for switchin...	9: modul 8
I.SP2	input for switching to SP2	1: input 1
Fn.SP2	function of input switchin...	0: direct
f.SP2	Forcing input switching to...	0: disabled
M.Pid2	input module for paramet...	9: modul 8
I.Pid2	input for parameter-switc...	2: input 2
Fn.Pid2	function of input paramet...	0: direct
f.Pid2	Forcing input parameter-s...	0: disabled
M.Co...	input module for controlle...	10: modul 9
I.CoFF	input for controller off-swit...	1: input 1
Fn.C...	function of input controlle...	0: direct
f.CoFF	Forcing input controller of...	0: disabled
M.bo...	input module for boost-fu...	10: modul 9
I.booS	input for boost-function	2: input 2
Fn.bo...	function of input boost-fu...	0: direct
f.booS	Forcing input boost-functi...	0: disabled
M.mAn	input module for switchin...	10: modul 9
I.mAn	input for switching a/m	3: input 3
Fn.mAn	function of input for switc...	0: direct
f.mAn	Forcing input for switchin...	0: disabled

### 4.2.1 Input module for switching to SP2 (M.SP2)

Select the module for switch-over to the 2nd set-point. Double-clicking in column "Value" will display a list of all digital input modules included in the VARIO station. One of these modules can be selected.

### 4.2.2 Input for switching to SP2 (I.SP2)

In this line, you can select the input of the relevant module, which shall activate the 2nd set-point. Dependent of built-in module, 2, 4 or 8 inputs are made available.

### 4.2.3 Function of input switching to SP2 (Fn.SP2)

For the selected input, the el. switching behaviour can be selected:

**0 Direct:** The 2nd set-point is activated, when 24V DC (H) are applied to the input.

**1 Inverse:** The 2nd set-point is activated, when 0V DC DC (L) are applied to the input.

**2 Toggle key function:** The first pulse activates the 2nd set-point and the second pulse de-activates it again. The min. pulse length is 100ms.

### 4.2.4 Forcing input switching to SP2

Unused digital inputs can be used for forcing. Forcing means that this input has stopped being part of the VARIO station and is now a digital input of the control system. The input signal is taken directly to the control system via the field bus rather than being processed in the VARIO station.

**Caution! Forcing of a digital input can be activated also, if this input was provided elsewhere for an operating function. In such a case, function "Forcing" is given priority.**

The other controller operating functions *M.Pid2*, *M.CoFF*, *M.booS* and *M.mAn* are handled in the same manner, but the functions are different.

### 4.3 External TC (ExtTc)

Kürzel	Bezeichnung	Wert
<b>ExtTc</b>	<b>Externe TK</b>	
InpMod	Eingangssignal von Modul	1: Gerät
InpInd	Eingangsnummer	2: Eingang 2
S.tYP	Sensortyp	20: Pt100 (-200...850°C)
Forcing	Forcing	1: aktiv

On page External TC, you can select 3 different modes of temperature compensation:

1. Internal temperature compensation
2. Cold-junction reference via an input of the VARIO station
3. External temperature compensation

**Caution!!! Temperature compensation modes 2 and 3 are not possible with all thermocouple input modules. For detailed specifications, see the module-specific data sheet.**

#### 4.3.1 Internal TC

When filling in "0" on line (**InpMod**) **Input signal of module** and selecting "disabled" on line 4 **Forcing**, the internal (built-in) temperature compensation is active. Further settings are not necessary.

#### 4.3.2 External TC via CD vario

The 2nd cold-junction temperature measurement method is by taking the compensating lead up to a junction box and using copper lead between the junction box and the VARIO station. The temperature inside the junction box is measured via a channel of the VARIO station and transferred to the other channels via the internal bus. Because of the accuracy and since thermocouple measurement also requires temperature compensation, this measurement may be done by means of a resistance thermometer.

#### 4.3.3 External TC via thermostat

The 3rd method implies the use of compensating lead up to a junction box connected to a thermostat and the leads between this junction box and CD VARIO can be of copper. The temperature of this thermostat is known (mostly 50 °C).

Input handling is as for an external temperature compensation, except that the input is "forced" with the thermostat temperature value. For this, **Forcing** must be set to "enabled".

Name	Description	Value
<b>ExtTc</b>	<b>External TC</b>	
InpMod	input signal of module	0: -
InpInd	input number	
S.tYP	sensor type	
Forcing	forcing	1: active

4.4 Mains voltage compensation

*Line conductor (L1)*

Name	Description	Value	on	Range
<b>L1</b>	<b>line conductor 1</b>			
InLP1	lower input value [phys]	207.0		-3000...3200
OuLP1	lower output value [phys]	7.200	<input checked="" type="checkbox"/>	-3000...3200
InHP1	upper input value [phys]	253.0		-3000...3200
OuHP1	upper output value [phys]	8.800		-3000...3200

As heating current measurement with compensation of the mains voltage variation was selected in the example, configuration of the analog input module is on this page. The remaining free inputs of this input module can always be used for measurement of other analog variables with standard signal.

4.4.1 Input signal of module (InpMod)

Here you can display a list of the analog input modules of the CD VARIO station by double clicking. Click on **Module 4** to select it (module 4 was provided for voltage measurement in the system configuration.)

4.4.2 Input number (InpInd)

Determine the input of the module selected previously on this line. Inputs 1 to 8 are available.

4.4.3 Sensor type (S.typ)

A pull-down menu provides a list of the analog input variables (standard signals) for which the analog input module can be configured:

current	0...20 mA	voltage	0...5 V
current	-20...20 mA	voltage	-5...5 V
current	4...20mA	voltage	0...10 V
current	0...40 mA	voltage	-10...10 V
current	-40...40 mA	voltage	0...25 V
		voltage	-25...25 V
		voltage	0...50 V

As the voltage transformer provides a nominal voltage of 7 V DC, input range 0...10 V is selected for this case.

4.4.4 Forcing

Forcing must not be activated in this case, because a true measured values is concerned.

For line conductors 2, 3 and other analog inputs, if applicable, configuration is analogous.

#### 4.5 Channel data

In section Channel data, the configuration of the (max. 30) controller channels is determined. The instantaneously handled channel is displayed in the uppermost line of the left part of the screen.

With several identical controllers/channels, configuration can be simplified by configuring a channel and copying it into the other (identical) channels:

Icon **Copy** or

header line: **Edit -> Copy ->** Select channels and data.

Name	Description	Value	Range
<b>Cntr</b>	<b>Controller</b>		
Cycle 1	cycle time for channel 1	3: 400 ms	
C.Fnc	control behaviour	2: D/Y switch-over	
C.Act	direction of operation	0: inverse, e.g. heating	
FAIL	behaviour at sensor break	2: mean correcting value	
SP.2C	cooling with SP.2	0: admitted	
CYCL	switching behaviour	0: standard	
LP.AL	loop alarm	1: LOOP alarm active	
AdtG	group selftuning	1: join group 1 selftuning	
Adt0	tuning of cycle time t1, t2	1: no tuning	
Tune	auto-tuning mode	1: impulse function at start up and setpoint	
Strt	start of auto-tuning	1: automatic + manual	
B.FAIL	reaction at bus error	0: none	
mGL	lower control range [phys]	0.000	-3000...899.0
mGH	upper control range [phys]	900.0	1.000...3200

##### 4.5.1 Cycle time for channel 1 (Cycle1)

This time was determined already in the connection wizard -> controller, where a semi-graphic method was used to determine an optimum between required and available cycle time. This result can be nullified here by (accidental) input of a value different from the one predefined.

**Therefore, the cycle time for the channel should be considered only as an information.**

Nevertheless, any modifications which are necessary should be done in the connection wizard, because the connection wizard enables the effects on the complete CD VARIO station to be considered clearly.

##### 4.5.2 Control behaviour (C.Fnc)

This selection menu includes all controller types which can be realized by means of a CD VARIO controller:

- 0: on/off controller (signaller)**
- 1: PID controller (2-point and continuous) <sup>1)</sup>**
- 2: D/Y-switchover <sup>2)</sup>**
- 3: 2x PID (3-point and continuous) <sup>1)</sup>**
- 4: three-point stepping controller**

<sup>1)</sup> Dependent on whether the (virtual) controller output is wired to a digital or a continuous output,

2/3-point or a continuous controller is provided. Or, if a continuous controller is provided, this (virtual) controller output must be wired to a continuous output. Technically, configuring a controller with an output which is both continuous and switching is possible.

<sup>2)</sup> For a D/Y controller, 2 digital outputs are required: Y1 is the switching output and Y2 is the changeover contact for D/Y.

### 4.5.3 Direction of operation (C.Act)

Selection of the direction of operation is dependent on the process. Normally, it is inverse: when it is too cold, heating (switch-on), and when it is too hot, cooling are necessary. Direct control is used only in very rare cases.

### 4.5.4 Behaviour at sensor break (FAIL)

A better description would be "Behaviour in case of sensor error", because determination how the controller should behave in case of sensor error (break, polarity error, short circuit) is made:

- 0: outputs off**
- 1: Y2 output**
- 2: mean correcting value**

Independent of correcting variable type and amount, a sensor break error message is output. This message can be read out via the system bus. Output as a group alarm is possible via one of the digital outputs. When the error is corrected, the controller returns automatically from this "error condition" to normal operation and the error messages will disappear.

In case of a sensor break with a three-point stepping controller, the controller outputs go to neutral condition: they are switched off.

#### 4.5.4.1 Outputs off

In case of an error, all outputs controlled by this controller are switched off. (Heating and cooling, or Open and Closed and all "additional outputs", because a controller can operate several (hardware) outputs.

#### 4.5.4.2 Y2 output

In this case, Y2 is a parameter which can be adjusted and which acts on all outputs of this controller in case of sensor error rather than being the 2nd (cooling) output of a controller.

#### 4.5.4.3 Mean correcting value

During normal operation, the mean value of the correcting variable is determined continuously. With good control, this value does not show important variations. When the correcting variable in the past 5 minutes did not vary by more than an adjustable percentage, the controller outputs this mean value of correcting variable in case of sensor error. The correcting variable can be changed by switching over to manual mode.

#### 4.5.5 Cooling with SP.2 (SP2C)

Two methods to reach the 2nd (lower) set-point are possible:

**0: admitted** With this setting, control to the 2nd set-point is with cooling.

**1: not admitted** Lowering the machine temperature to the 2nd (stand-by) set-point in case of prolonged operation pauses need not be done with cooling (energy saving!). The machine is permitted to cool down naturally to the 2nd set-point, which is maintained by controlling.

#### 4.5.6 Switching behaviour (CYCL)

Adjust the characteristic of switching behaviour (only with 2 and 3-point controllers). With switching controller, the correcting variable is changed by variation of the duty cycle. A general recommendation which method should be selected is not possible, because this question is dependent on machine and user philosophy.

**0: Standard** In the standard setting, the (adjusted) minimum cycle time is reached only with a 50 % duty cycle. With smaller duty cycle, the OFF time is increased, or, with long duty cycle, the ON time is increased. The result is a "bath-tub life curve". This method offers the advantage to minimize the number of switching cycles (contactors) automatically. A minor disadvantage is that the process can become slightly instable with very long and very short duty cycles.

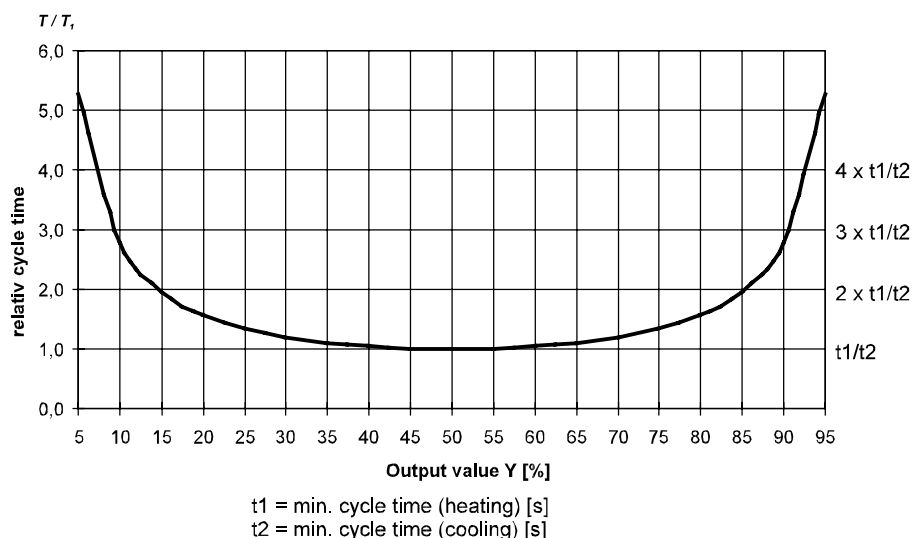

**1: with constant cycle** With this method, a constant cycle time is always used. The duty cycle can decrease down to the adjusted value, or the min. cycle time (100ms) of CD VARIO. An even lower duty cycle which might be required by control is "accumulated" over several cycles and output. I.e. there may be several cycles with only "OFF time". Analogously, this applies also to small OFF times.

### 1: Water cooling linear

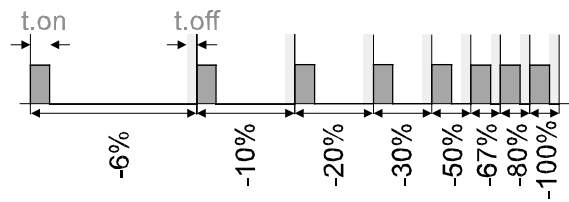

The standard method (CYCL = 1) is used for heating. For cooling, a special algorithm for water cooling is used. Generally, cooling is enabled only from an adjustable temperature (E.H2O), because evaporation with the associated cooling effect is not possible at temperatures below 100 °C.

The pulse length is adjusted in parameter t.on. It is fixed for all correcting variables. The "off time" is varied dependent on correcting variable. The minimum "off time" can be determined in parameter "t.off". Output of shorter off pulses is suppressed. The maximum effective cooling output signal is determined by  $t.on / (t.on + t.off) * 100$  [%].

### 2: Water cooling non linear

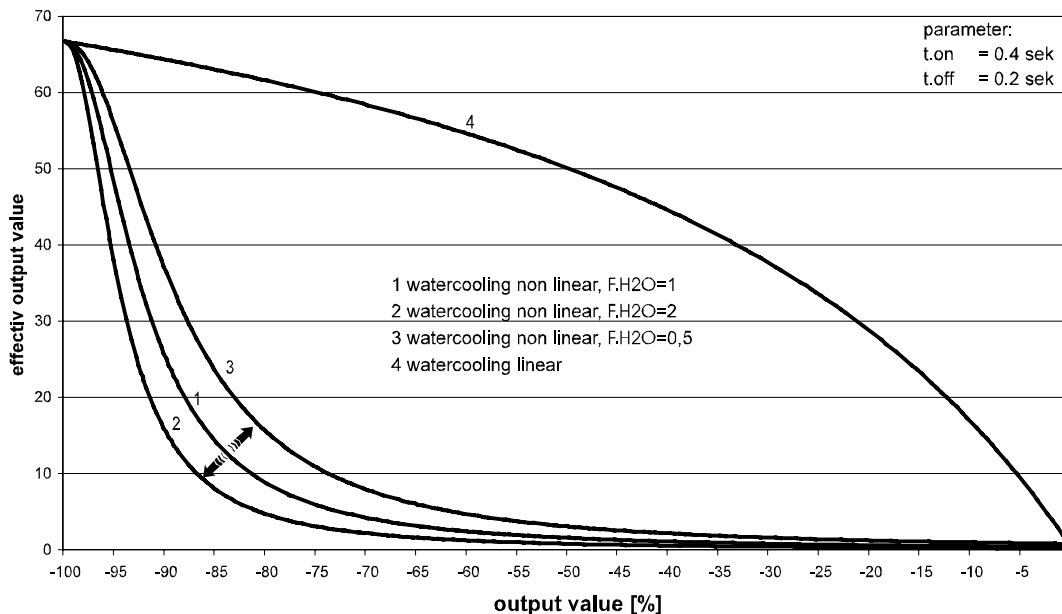
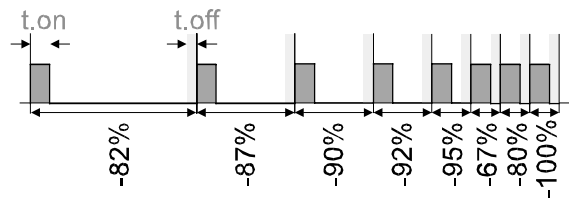

Normally, the cooling effect is much stronger than the heating effect, whereby the control behaviour may be impaired when changing over from heating to cooling. This method provides compensation for this disadvantage.



---

## Functional-Description CD vario

---

The cooling effect is very weak within 0% - 70% output signal. When exceeding this value, the correcting variable will increase to maximum possible cooling energy very quickly. Parameter F.H2O can be used to change the characteristic curve.

For heating, the standard method is also used, and cooling is also enabled dependent on the process temperature.

**3: with constant cycle** With this method, the cycle time is always constant. The "on" time can decrease to the adjusted value, or to the min. cycle time of CD VARIO (100ms). For even lower values, the switch-on time is accumulated over several cycles and output. I.e. several cycles with only "off time" are possible. Analogously, the same applies for small off times.

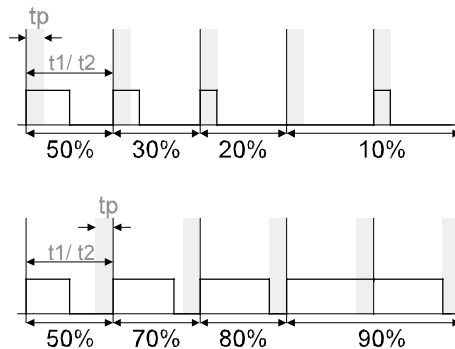

### 4.5.7 Loop alarm (LP.AL) (control loop monitoring, loop alarm)

This parameter can be used to switch the loop alarm for the relevant channel on or off.

For description of the loop alarm, see section 3.6.3.

## 4.5.8 Self-tuning

### 4.5.8.1 General

In order to determine the optimum process parameters, self-tuning is possible. After start by the operator, a self-tuning attempt is made by the controller (or controllers, in case of group self-tuning). In this attempt, the controller calculates the optimum parameters for quick line-out to the setpoint without overshoot from the process characteristics.

If enabled by configuration, the following parameters can be optimized during self-tuning:

#### Parameter set 1:

Pb1 = proportional band 1 (heating) in units of the physical quantity [e.g. °C]

t<sub>i</sub>1 = integral action 1 (heating) in [s]

t<sub>d</sub>1 = derivative action 1 (heating) in [s]

t1 = minimum cycle time 1 (heating) in [s]

Pb2 = proportional band 2 (cooling) in units of the physical quantity [e.g. °C]

t<sub>i</sub>2 = integral action 2 (cooling) in [s]

t<sub>d</sub>2 = derivative action 2 (cooling) in [s]

t2 = minimum cycle time 2 (cooling) in [s]

**Parameter set 2:** analogous to parameter set 1

### 4.5.8.2 Self-tuning preparation

- Set the application-specific range of the controller as control range limits, i.e. **rnGI** and **rnGH** should be set to the actually required limits for control.

Configuration	Controller	lower control range	upper control range
---------------	------------	---------------------	---------------------

Configuration ->	Cntr ->	rnGI ->	rnGH
------------------	---------	---------	------

- Determine which parameter set should be optimized. The instantaneously effective parameter set is optimized. Activate the required parameter set (1 or 2).
- Determine which parameter set should be optimized (see table above).
- Select the required self-tuning method.
  - step function at start-up + impulse function at setpoint
  - impulse function at start-up and at setpoint
  - only step function at setup

### 4.5.8.3 Self-tuning after start-up or at the setpoint

Self-tuning after start-up and at the setpoint are possible. As control parameters are always optimal only for a limited process range, different methods dependent of requirements can be selected. With significant differences in the process behaviour after start-up and directly at the setpoint, different self-tuning methods for parameter sets 1 and 2 can be selected. Process-dependent switchover between parameter sets is possible.

**4.5.8.3.1 Self-tuning after start-up**

Self-tuning after start-up requires a certain separation of process value and setpoint. Due to the separation, the controller is able to estimate the process and to determine the control parameters during line-out to the setpoint.

This method optimizes the control loop from the start conditions to the setpoint, i.e. a wide control range is covered.

We recommend selecting self-tuning method **Tune = 2** "Step function at start-up".

**4.5.8.3.2 Self-tuning at the setpoint**

For self-tuning at the setpoint, the controller outputs a disturbance signal to the process. This is done by shortly varying the correcting variable. The process value varied by this pulse is evaluated. The determined process data are converted into control parameters and stored in the controller.

This method optimizes the control loop directly at the setpoint. The advantage is in the small control deviation during self-tuning.

**4.5.8.4 Selection of the method**

Criteria for selection of the self-tuning method are:

	<b>Step function at start-up</b>	<b>Impulse function at start-up</b>	<b>Optimization at the setpoint</b>
tune=0	sufficient setpoint reserve is provided		sufficient setpoint reserve is <b>not</b> provided
tune=1		sufficient setpoint reserve is provided	sufficient setpoint reserve is <b>not</b> provided
tune=2	always step function at start-up		

**Sufficient setpoint reserve:**

inverse controller: (with process value < setpoint - (10% of r<sub>nGH</sub> - r<sub>nGI</sub>))

direct controller: (with process value > setpoint + (10% of r<sub>nGH</sub> - r<sub>nGI</sub>))

**4.5.8.5 Step function at start-up**

Condition: **Tune = 0** and sufficient setpoint reserve provided **or**  
**Tune = 2**

The controller outputs 0% correcting variable or **Y.Lo** and waits, until the process is at rest.

Subsequently, a 100% step change of correcting variable is output.

The controller makes an attempt to calculate the optimum control parameters from the process response. In case of success, these optimized parameters are used for line-out to the setpoint.

With *3-point controller*, this procedure is followed by "cooling". After the 1st step as described, a correcting variable of - 100% (100% cooling energy) from the setpoint is output. After successful determination of the "cooling parameters", the optimized parameters are used for line-out to the setpoint.

### 4.5.8.6 Impulse function at start-up

Condition: **Tune** = 1 and sufficient setpoint reserve provided. The control outputs 0% correcting variable or **Y.Lo** and waits, until the process is at rest.

Subsequently, a short pulse of 100% is output

(Y= 100%) and reset immediately.

The controller attempts to calculate the optimum control parameters from the process response. In case of success, these optimized parameters are used for line-out to the setpoint.

With *3-point controller*, this procedure is followed by "cooling". After completing the 1st step as required and line-out to the setpoint, the "heating correcting variable" remains unchanged and a cooling pulse (100% cooling energy) is output **additionally**. After successful determination of the "cooling parameters", line-out to the setpoint is by means of the optimized parameters.

### 4.5.8.7 Self-tuning at the setpoint

Conditions:

- A sufficient setpoint reserve is not provided at self-tuning start.
- **Tune** is set to 0 or 1
- If **Strt** (self-tuning at start) is configured and the controller detects a process value oscillation by more than  $\pm 0,5\%$  of **rnGH - rnGl**, the control parameters are preset for process stabilization and the controller undergoes *self-tuning at the setpoint*.
- The step attempt after power on has failed.
- With active *ramp function*, the setpoint ramp is started from the process value, i.e. a sufficient setpoint reserve is not built up.

**4.5.8.8 Optimization at the setpoint procedure**

Line-out to the setpoint is by means of the instantaneous controller parameters. After line-out to the setpoint, the controller makes an impulse attempt. This impulse reduces the correcting variable by max. 20% <sup>\*)</sup>, in order to generate a slight process value undershoot. The changing process is analyzed and the parameters thus calculated are stored in the controller.

Line-out to the setpoint is by means of the optimized parameters.

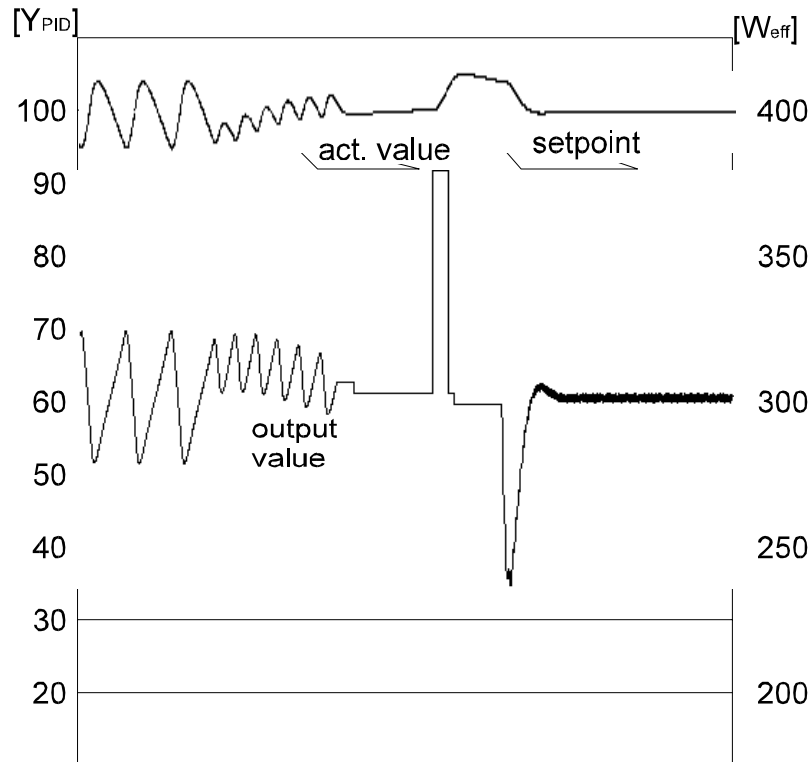

With *3-point controller*, either the "heating" or the "cooling" parameters are optimized dependent of the instantaneous condition. These two self-tuning methods should be started separately.

<sup>\*)</sup>If the correcting variable is too small for reduction in lined out condition, it will be increased by max. 20 %.

**4.5.8.9 Self-tuning at the setpoint for 3-point stepping controller**

With 3-point stepping controllers, the impulse attempt can be made with or without position feedback. Unless feedback is provided, the controller calculates the actuator position internally by varying an integrator with the adjusted actuator travel time. For this reason, exact specification of the motor travel time (**tt**) as time between stops is extremely important. Due to position simulation, the controller knows whether an upscale or downscale pulse must be output. After power-on, the position simulation is at 50%. Once the motor actuator was varied by the adjusted travel time in one go, calibration occurs, i.e. the position corresponds to the simulation:

Calibration is always, when the motor actuator was varied by the actuator travel time (**tt**) without pause, independent whether in manual or automatic mode. Any interruption of the variation cancels the calibration. Unless done at self-tuning start, calibration is automatic by closing the actuator once.

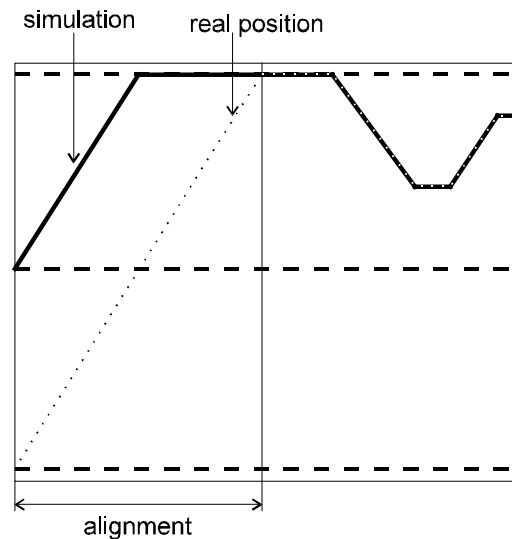

Unless the positioning limits were reached within 10 hours, there may be a major deviation between simulation and actual position. In this case, the controller would make a minor calibration at self-tuning start, i.e. the actuator would be closed by 20% once followed by 20% opening. Now, the controller knows that the correcting variable reserve for the attempt is 20%.

### 4.5.8.10 Self-tuning start

Start condition:

- To evaluate the process, a stable condition is required. After self-tuning start, the controller waits, until the process is at rest (PiR = process at rest). The rest condition is reached, when the process value oscillation is smaller than  $\pm 0,5\%$  of  $rnGH - rnGL$ .
- For starting the self-tuning after start-up, a 10% separation of ( $SP.Hi - SP.LO$ ) is necessary. As values and should always be within the control range, there is no limitation with correct adjustment of these values.

### 4.5.8.11 Self-tuning cancelation

**by the operator:**

Self-tuning can be canceled at any time by the operator; via the engineering tool or by an order via the fieldbus. With controller switch-over to manual operation after self-tuning start, self-tuning is canceled. Cancelation causes the controller to continue operation using the old parameter values.

**by the controller:**

If the control conditions prevent successful self-tuning, the controller cancels the self-tuning. The controller continues controlling using the parameters valid before self-tuning start. If self-tuning was started from manual mode, the controller returns to the correcting variable valid last after self-tuning start.

4.5.8.12 Causes of cancelation and error messages

Error status	Description	Measures
0	No error	
3	Wrong output action	Re-configure controller (inverse <-> direct)
4	No reaction of the control variable	The control loop is perhaps not closed, Check sensors, connections and process
5	Low reversal point	Increase the max. output limiting <b>YH</b> , or reduce the min. output limiting <b>YL</b> .
6	Exceeded setpoint risk (parameter determined)	Increase (inverse) or reduce (direct) the setpoint, start from lower process value.
7	Output step change too small ( $\Delta Y < 5\%$ )	Increase the max. ouput limiting <b>YH</b> or reduce the min. output limiting <b>YL</b>
8	Setpoint reserve too small	Increase (inverse), reduce (direct) the setpoint or reduce the setpoint adjustment range.
9	Pulse attempt failed	The control loop is perhaps not closed: check sensors, connections and process.

4.5.8.13 Examples for self-tuning attempts  
(controller inverse, heating or cooling)

**Start: heating energy switched on**

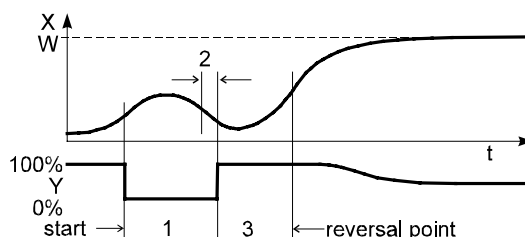

Heating energy Y is switched off (1). When the change of process value X is constant during one minute (2), the energy is switched on (3). At the reversal point, the self-tuning attempt is finished, and control to the setpoint is by means of the new parameters.

**Start: heating energy switched off**

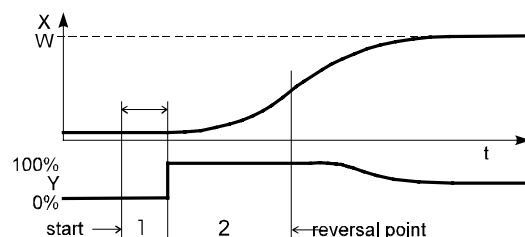

The controller waits 1,5 minutes (1). Heating energy Y is switched on (2). At the reversal point, the self-tuning attempt is finished, and control to setpoint W is by means of the new parameters.

**Self-tuning at the setpoint**

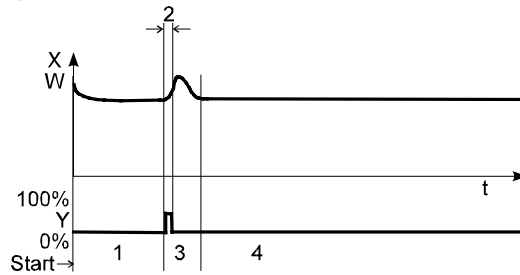

The controller controls to the setpoint. When the control deviation is constant (1) during a certain time, (i.e. constant separation between process value and setpoint), the controller outputs a reduced correcting variable pulse (max. 20%) (2). After determining its parameters from the process value curve (3), the controller changes to control operation using the new parameters.

**Three-point controller**

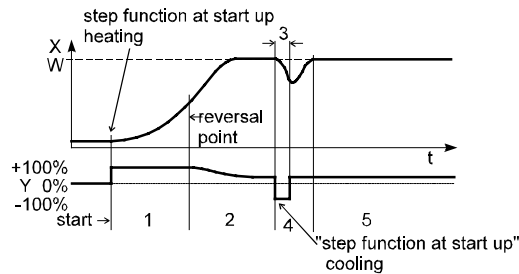

The parameters for heating and cooling are determined in an attempt. The heating energy is switched on (1). At the reversal point, the heating parameters **Pb1, ti1, td1 and t1** are determined. Line-out to the setpoint takes place (2). When the control deviation is constant, the controller outputs a cooling correcting variable pulse (3). After determining its cooling parameters **Pb2, ti2, td2 and t2** from the process value curve (4), the controller changes to control operation using the new parameters (5).



4.5.8.14 Manual self-tuning

With instruments for which the control parameters should be adjusted without self-tuning, the parameter adjustment effects shown below are useful to determine optimum parameters. For this purpose, the time curve of variable X after a step change of correcting variable Y can be used. Usually, it is not possible to plot the complete response curve (0 to 100%), as the process must be kept within certain limits. Values  $T_g$  and  $X_{max}$  (complete step response from 0 to 100 %) or  $\Delta t$  and  $\Delta x$  (partial step response) can be used to determine the maximum rate of increase  $v_{max}$ .

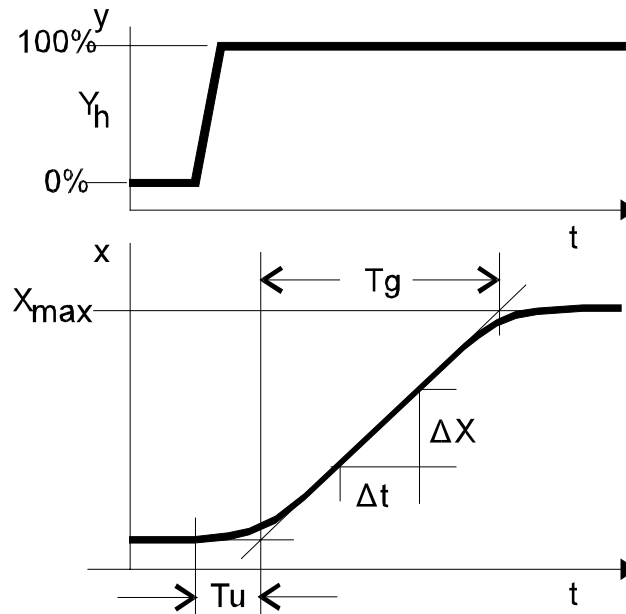

- Y = correcting variable
- $Y_h$  = control range
- $T_u$  = delay time (s)
- $T_g$  = recovery time (s)
- $X_{max}$  = max. rate of increase of process value

$$v = \frac{X_{max}}{T_g} = \frac{dx}{dt} = \text{max. rate of increase of process value}$$

The control parameters can be determined from the calculated values of delay time  $T_u$ , maximum rate of increase  $v_{max}$  and characteristic value K according to the **formulas** given in the table below. Increase **Pb1**, if line-out to the setpoint oscillates.

## Functional-Description CD vario

---

### Parameter adjustment effects:

Parameter	Control	Line-out of disturbances	Start-up behaviour
<b>Pb1</b>	higher	increased damping	slower line-out
	smaller	reduced damping	faster line-out
<b>td1</b>	higher	reduced damping	faster response
	smaller	increased damping	slower response
<b>ti1</b>	higher	increased damping	slower line-out
	smaller	reduced damping	faster line-out

### Formulas:

Control action	Pb1 [phys. quantity]	td1 [s]	ti1 [s]
<b>PID</b>	1,7*K	2*Tu	2*Tu
<b>PD</b>	0,5*K	Tu	off
<b>PI</b>	2,6*K	off	6*Tu
<b>P</b>	K	off	off
<b>Three-point stepping controller</b>	1,7*K	Tu	2*Tu

$$K = V_{\max} * T_u$$

With 2-point and 3-point controllers, the duty cycle should be set to  $t1/t2 \leq 0,25 * T_u$ .

#### 4.5.9 Group self-tuning (AdtG)

Max. 4 self-tuning groups are possible in a CD VARIO station. Specify in this line, if a controller should belong to a group and to which group it should belong. For each controller, single or group self-tuning can be selected. Single tuning is also possible, even for a group controller.

- 0 No group self-tuning**
- 1. Join group 1 self-tuning**
- 2. Join group 2 self-tuning**
- 3. Join group 3 self-tuning**
- 4. Join group 4 self-tuning**

Group self-tuning is common self-tuning of several controllers (channels). This is purposeful with completely independent processes (time saving as compared to single tuning) and compulsory for processes with close thermal coupling, e.g. injection moulder heatings. Common start of several group self-tunings is not possible. However, the individual groups can be started in (short) succession.

With group self-tuning, self-tuning start is in common, i.e. the rest condition must be met for all controllers before group self-tuning starts. Reaching the rest condition may take all controllers more than a minute, especially if the machine is still warm. After common start, self-tuning is done (and finished) individually by each controller.

The result on the message is collected internally in CD VARIO and output after finishing (or cancellation) of the last self-tuning. Unless self-tuning could be finished after 1 hour, whatever the reasons are, self-tuning is cancelled and the old parameters remain unchanged.

Group self-tuning will only coordinate self-tuning after start-up, no matter if the step change or pulse method is used. Cooling self-tuning of a three-point controller is also coordinated, because included in self-tuning after start-up. Self-tuning at the setpoint (heating or cooling) is not coordinated. The start of any group self-tuning will start self-tuning at the setpoint immediately and all controllers without self-tuning at the setpoint must meet the conditions of the step method before being started in common.

#### 4.5.10 Tuning of cycle time t1,t2 (Adt0)

##### **0: automatic tuning**

This setting can be used to optimize the cycle time. To protect the switching elements (contactors, relays), the cycle time should be high (i.e. the number of switching cycles should be low). For a good control result, the requirements are exactly the contrary. With tuning of cycle time selected, an algorithm in CD VARIO ensures that an optimum compromise between the two requirements is found. The process data determined during tuning are used as a basis for this calculation.

##### **1: no tuning**

With tuning of cycle time switched off, the adjusted value <sup>\*</sup>) (default value 10 sec) is used for the cycle time.

<sup>\*</sup>) For adjustment, see: Parameter -> Channel data -> Controller -> t<sub>1</sub> t<sub>2</sub>

#### 4.5.11 Auto-tuning mode (Tune)

Determines the auto-tuning mode for each controller.

##### **0 Step function at start-up and impulse function at setpoint**

If auto-tuning mode = 0 was selected, auto-tuning is done with step function after start-up and auto-tuning at the setpoint with a pulse is permitted.

##### **1 Impulse function at start up and setpoint**

If auto-tuning mode = 1 was selected, auto-tuning is done with impulse function after start-up and auto-tuning at the setpoint with a pulse is permitted.

In both cases, auto-tuning is done with an impulse function at the setpoint, if the control deviation is smaller than 10% (of the control range).

##### **2 Only step function at start-up**

Auto-tuning is only with a step attempt after start-up.

#### 4.5.12 Start of auto-tuning (Strt)

There are two modes to start auto-tuning:

**0: Only manual** Auto-tuning can be started via the engineering tool or via a machine control system. Auto-tuning is done only once.

**1: Automatic + manual** Auto-tuning is always started after machine switch-on, or when the process value oscillates by more than 4 % of the control range and with simultaneous variations of the correcting variable by more than 20 %. This auto-tuning method should be used very purposefully, because (time-consuming) auto-tuning is always done after machine switch-on, although no process change occurred.

#### 4.5.13 Reaction at bus error (B.FAIL)

Determine the behaviour of the VARIO station in case of bus error.

**0: none:** means that the VARIO station continues operating as before rather than showing a defined reaction on a bus error. Control and error evaluation operate as with intact bus, except that no error messages can be sent to the PLC.

**1: like sensor fault:** The VARIO station goes to the condition, which was configured for the case of a sensor error. (Continuation with a defined output percentage might be required.)

**2: Controller off:** means that all outputs are switched off.

#### 4.5.14 lower control range (rnGL)

#### 4.5.15 upper control range (rnGH)

The two parameters have rather an internal signification. They are used as a base e.g. for the control parameters. The proportional band, for instance, relates to the difference between these two values. I.e. the measuring range or the setpoint range can be changed without causing a change of the control behaviour ( $X_p$ ).

The two values **rnGL** and **rnGH** should be as high as the setpoint adjustment range **SP.Lo** and **SP.Hi**.

By reducing the control range, the self-tuning sensitivity can be increased.

### 4.6 Input (InP)

Name	Description	Value
<b>InP</b>	<b>Input</b>	
InpMod	input signal of module	7: modul 6
InpInd	input number	1: input 1
S.TYP	sensor type	0: TC type L (-100...900°C)
Forcing	forcing	0: Disabled
Ext.TC	external TC	0: internal TC
X.korr	measured value correction	0: no correction

#### 4.6.1 Input signal of module 1 (InpMod)

Define the relevant input module in this line.

#### 4.6.2 Input 1 (InpInd)

Specify the input of the input module selected above in this line.

**Note: Settings 4.6.1 and 4.6.2 were done already with the connection wizard.**

**4.6.3 Sensor type (S.tYP)**

Dependent on the input module selected in *InpMod*, the sensor type, or the input type for the input selected in *Inplnd* can be selected in this line. The various module input types are listed in the following tables.

**Controller and combined I/O modules**

**CD VARIO T8/UTH, CD VARIO T4/UTH, VARIO UTH8-DO8, VARIO UTH4-DO8**

Int. no.	Type	Range
0	L	-100...900 °C
1	J	-100...1200 °C
2	K	-100...1350 °C
3	N	-100...1300 °C
4	S	0...1760 °C
5	R	0...1760 °C
6	T	-200...400 °C
7	C	0...1760 °C
8	D	0...1760 °C
9	E	-100...1000 °C
10	B	0...1820 °C
47	Direct voltage	0...70 mV

**CD VARIO T6/RTD, CD VARIO T4/RTD, VARIO RTD6-DO6**

Int. no.	Type	Range
20	Pt100	-200...850 °C
27	Resistance	0...450 Ω

**Analog input modules**

**VARIO UTH2**

Int. no.	Type	Range
0	L	-100...900 °C
1	J	-100...1200 °C
2	K	-100...1350 °C
3	N	-100...1300 °C
4	S	0...1760 °C
5	R	0...1760 °C
6	T	-200...400 °C
7	C	0...1760 °C
9	E	-100...1000 °C
10	B	0...1820 °C
11	W	
48	Direct voltage	-15...85 mV

**VARIO RTD2**

Int. no.	Type	Range
20	Pt100	-200...850 °C
21	Pt1000	-200...850 °C
22	Ni100	-60...180 °C
23	Ni1000	-60...180 °C
24	KTY 81-110	-55...150 °C
25	KTY 84	-40...300 °C
26	Resistance	0...400 Ω
28	Resistance	0...4000 Ω

## Functional-Description CD vario

---

### VARIO AI 2/SF

Int. no.	Type	Range
30	Current	0...20 mA
31	Current	-20...20 mA
32	Current	4...20 mA
42	Voltage	0...10 V
43	Voltage	-10...10 V

### VARIO AI 8/SF

Int. no.	Type	Range
30	Current	0...20 mA
31	Current	-20...20 mA
32	Current	4...20 mA
33	Current	0...40 mA
34	Current	-40...40 mA
40	Voltage	0...5 V
41	Voltage	-5...5 V
42	Voltage	0...10 V
43	Voltage	10...10 V
44	Voltage	0...25 V
45	Voltage	-25...25 V
46	Voltage	0...50 V



#### 4.6.4 Forcing (Forcing)

**0: disabled**

**1: enabled**

With analog input forcing, the PLC determines a fixed (or variable) value which is processed further as required by the VARIO station. E.g. an input can be "forced" to the temperature of an external thermostat (for temperature compensation).

#### 4.6.5 External TC (Ext.TC)

This line is accessible only, if a module with thermocouple inputs was selected in line "Input signal of module x". In this line, you can determine the type of temperature compensation for the channel defined in "InpInd". The external temperature compensation and its predefined values are valid for the complete VARIO station. Theoretically, using both internal and external temperature compensation in a VARIO station is possible (but not reasonable).

#### 4.6.6 Enable measured value correction (X.korr)

In this item, 2 methods to influence the measured value can be enabled:

**0: no correction**

**1: 2-point correction**

**2: scaling**

**0 no correction** means that the process value cannot be influenced at all. The "raw measured value" is used without correction.

##### **1: 2-point correction**

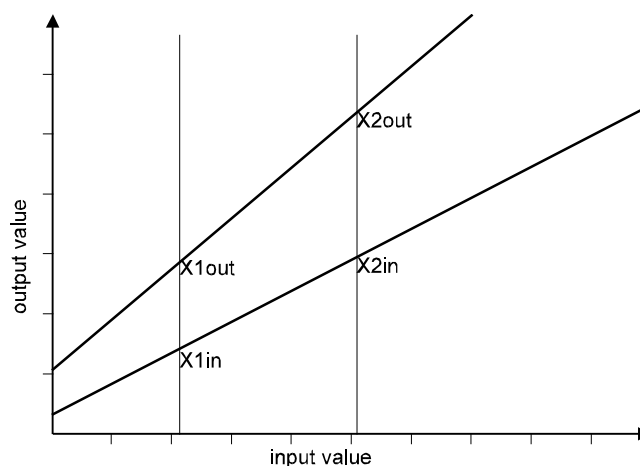

2-point correction can be used to compensate process value errors which are caused e.g. by undue installation of the sensor, or to correct tolerances of several sensors. For each controller, max. 2 values can be corrected: rotation and/or parallel shifting of the curve are possible. In this line, you can determine only, if a correction is required. The actual corrective values can be defined only in the visualization, where the "raw measured values" are displayed. This corrected process value curve is used for all further calculations (control deviation, alarms, limit values...) of the relevant channel. However, the "raw measured value" is still available via the field bus and via the engineering tool.

An "online" measured value correction is possible by means of the visualization:  
All instantaneous process values ( $x_{1in}$ , or  $x_{2in}$ ) are displayed. By an entry into  $x_{1out}$  or  $x_{2out}$ , this value can be corrected as required (e.g. into a value determined with a precision instrument).

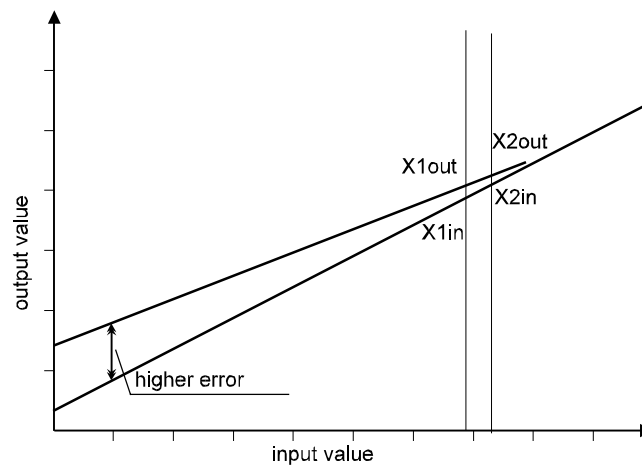

**Caution:** As only 2 values can be corrected, significant deviations may occur for values beyond the correction range; if both corrective values are near the span end, there are significant deviations near the span start (see figure b). Vice versa, the same principle is applicable: corrective values near the span start cause a significant deviation near the span end.

After realization, measured value correction is stored only in the VARIO station. To save these data, which were created with relatively high expenditure, an "upload" (from controller to PC) is required and this .bct file should be used as a basis for subsequent extensions and changes.

**2: Scaling** If the sensor for process value measurement is a transmitter with standard output signal ( e.g. weight -> 0...10V), this input can be enabled for scaling in units of the physical quantity. (This item is only provided to activate the scaling). Scaling itself is in Parameter -> Channel -> Inputs -> InL, OuL or InH, OuH;). Scaling is always written into the instrument by BlueControl, whilst measured value correction is written only on request ("Transfer measured value correction").

2-point correction is on-line scaling; whereas scaling is an off-line 2-point correction. The controller in the VARIO station does not distinguish scaling and measured value correction. In the engineering tool, however, distinction between these two data is made. Scaling is done in the engineering tool and always transmitted to the controller. Measured value correction occurs in visualization (operating page) in the controller itself and is provided only in the controller originally after realization. These data are only available in the engineering tool after uploading.

#### 4.6.7 Logic (LOGI)

Name	Description	Value
<b>LOGI</b>	<b>Logic</b>	
SP.2	2nd setpoint	1: digital input
mAn	automatic/manual switching	0: interface only
C.oFF	controller off	0: interface only
booS	boost function	0: interface only
Pid.2	parameter switch-over	1: digital input

This page can be used to determine one of five controller operation methods. Selection is between:

**0: Digital input** means that this function can be switched over both via the fieldbus and the digital input. After switch-on, the digital input is given priority. When the digital input is set for a defined function, the interface is without effect. Also with the digital interface switched off, the function can be switched on via the interface.

**1: Interface only** means that this function can be switched over only via the field bus.

#### 4.6.8 Set-point (Setp)

Name	Description	Value
<b>Setp</b>	<b>Setpoint</b>	
SP.Fn	setpoint processing	1: standard + start-up
TypEi...	Type of input signal	1: Y1 analog
ChnSrc	Signal source channel	1: channel 1

As to setpoint processing, this page has a double function:

1. with or without start-up circuit
2. determination, if setpoint or cascade controller is required

##### 4.6.8.1 Setpoint processing (Setp)

**0: no start-up function** means that no start-up circuit is used, independent of whether a setpoint or a cascade controller is concerned.

**1: standard \* start-up** The start-up circuit is activated for this controller. If this is cascade control (setpoint/cascade controller), the start-up circuit is effective only for the cascade controller.

(The values for start-up circuit must be specified in "Parameter".)

#### 4.6.8.2 Type of input signal (TypEing)

Cascade control is not explicitly adjusted. It is achieved by determining the setpoint type and source for this controller accordingly in the following two lines.

**0; Weff** The setpoint is determined by visualization or via a PLC. In this case, a setpoint controller is defined.

By selecting 1, 2 or 3, this controller is defined as slave controller in a cascade.

**1: Y1 analog** is the correcting variable of a controller, if the control deviation is negative (process value < setpoint), e.g. heating.

**2: Y2 analog** is the correcting variable of a controller, if the control deviation is positive (process value > setpoint), e.g. cooling.

**3: Ypid** is the overall correcting variable of a controller.

Y1 and Y2 can be only positive values, Y3 can be positive and negative.

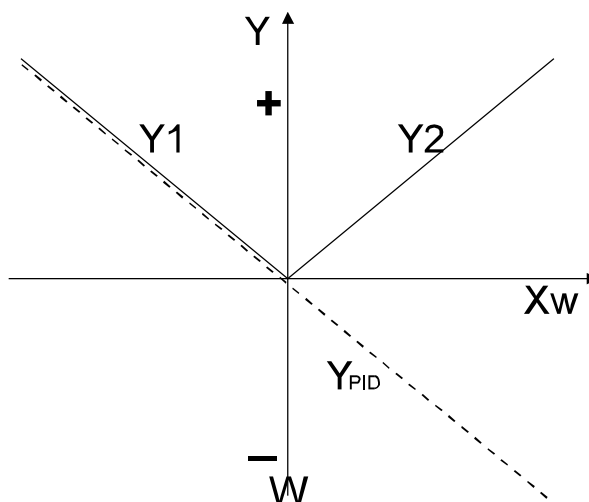

#### 4.6.8.3 Signal source channel (ChnSrc)

In this line, the channel from which the set-point for this controller should come is determined. Channels 1...30 are available.

**Channel 1**

·  
·  
·

**Channel 30**

**Caution!!!** Unused channels can also be selected. In this case, no controller cascade is built up.

#### 4.6.9 Limit (Lim)

The limit values are configured on this page.

Name	Description	Value
<b>Lim</b>	<b>Limit</b>	
Fcn.1	function of limit 1	1: measurement value
Src.1	source of limit 1	2: deviation + suppression
Fcn.2	function of limit 2	2: measurement value with latch
Src.2	source of limit 2	5: correcting variable
Fcn.3	function of limit 3	2: measurement value with latch
Src.3	source of limit 3	6: deviation to SP internal

Each of the 30 controllers can be provided with max. 3 limit alarms. These limit alarms are 30 independent alarms, which can be configured and parameterized freely (within the predefined limits). (Limit value alarm does not necessarily mean alarm signalling, the limit value alarm can be used also for activation of controller or machine actions.)

##### 4.6.9.1 Function of limit 1 (Fcn.x)

Possible selections are:

**0: switched off** - This alarm is switched off.

**1: measurement value** - The measurement value of this input is monitored for out-of-limits. When the limit value is exceeded, an alarm is output. The alarm is reset automatically, when the measured value is within the limits again (including hysteresis).

**2: measurement value with latch** - The measurement value of this input is monitored for out-of-limits. When the limit value is exceeded, an alarm is output. The alarm is not reset automatically, when the measured value is within the limits again. The alarm output remains set and must be reset manually via the field bus or the engineering tool.

##### 4.6.9.2 Source of limit (Src.x)

The following sources for the limit value can be selected:

**0: process value** - The process value as an alarm variable is a absolut alarm. This alarm is used for monitoring the absolut value from the set-point. Therefore, this value must have a polarity sign in the parameters.

**1: deviation** - The deviation as an alarm variable is a relative alarm. This alarm is used for monitoring the deviation from the set-point. Therefore, this value must have a polarity sign in the parameters.

**2. deviation + suppression** - Like 1., however, the alarm is suppressed until the process value was within the limits (set-point minus hysteresis) once e.g. after start-up. Now, the alarm is activated and triggered, when the process value falls below the limit again.

## Functional-Description CD vario

---

**3. setpoint** The set-point is monitored (cascade control: when the setpoint of a slave controller increases unduely, the fault may be due to the master controller.)

**4. correcting variable** Correcting variable  $Y_{pid}$  is monitored (e.g. an increase of the correcting variable - with otherwise unchanged conditions - can indicate reduced heating energy, failure of a line conductor, corrosion of heating elements...)

**5. deviation to SP internal** Monitoring for deviation from the internal setpoint. With an activated start-up or ramp function, for instance, monitoring for the "end setpoint" is provided with this adjustment, whereas only the instantaneously effective setpoint is monitored with normal control deviation.

**Caution!!! Only one alarm bit is available, no matter if a low or high limit is exceeded.**

## 5 Parameter

This part of the engineering tool is provided for determination of the configuration values of a CD VARIO station.

### 5.1 Device

#### 5.1.1 General

Name	Description	Value	Range
<b>Allg</b>	<b>General</b>		
Gef.Del	Offset of lead setpoint [phys.]	5.000	0.100...3000

On this page, the parameters of controlled heat-up can be adjusted. This extensive subject is described in section **5.6 Controlled setpoint tracking**.

#### 5.1.2 External TC

This page can be edited only after having been ticked "on" in the checkbox.

Name	Description	Value	on	Range
<b>ExtTc</b>	<b>External TC</b>			
InLTk	lower input value [phys]	0.000		-3000...3200
OuLTk	lower output value [phys]	0.000	<input checked="" type="checkbox"/>	-3000...3200
InHTk	upper input value [phys]	100.0		-3000...3200
OuHTk	upper output value [phys]	100.0		-3000...3200

When using a transmitter with standard signal for measurement of the cold-junction temperature of an external temperature compensation, scaling (standard signal -> temperature) can be determined on this page.

**lower input value (InLTk)** This is the standard signal span start value (e.g. 4 mA).

**lower output value (OuLTk)** This is the temperature value corresponding to the lower input value (e.g. 0 °C).

**upper input value (InHTk)** This is standard signal span end value (e.g. 20 mA).

**upper output value (OuHTk)** This is the temperature value corresponding to the upper input value (e.g. 60 °C).

If the system is designed for °F, fill in the relevant Fahrenheit values.

5.1.3 Line conductor 1 (L1)

Name	Description	Value	on	Range
<b>L1</b>	<b>line conductor 1</b>			
InLP1	lower input value [phys]	207.0		-3000...3200
OuLP1	lower output value [phys]	7.200	<input checked="" type="checkbox"/>	-3000...3200
InHP1	upper input value [phys]	253.0		-3000...3200
OuHP1	upper output value [phys]	8.800		-3000...3200

Similar to the external temperature compensation, this page is provided for scaling of the voltage converter used for correction of the heating current measurement. Scaling is dependent on the voltage converter. For the mains voltage converter sold by CDA (KSVC-109\_30001), the scaling is:

207 V AC -> 7,2 V DC and 253 V AC -> 8,8 V DC

The linearity is < 1% for the nominal voltage  $\pm 10\%$ , and < 2% for nominal voltage  $\pm 20\%$ .

**lower input value (InLP1)** Fill in the mains voltage value corresponding to span start (e.g. 207 V AC).

**lower output value OuLP1** is the value output by the voltage converter at its span start value (e.g. 7,2 V DC).

**upper input value (InHP1)** Fill in the mains voltage value corresponding to the span end (e.g. 253 V AC).

**upper output value (OuHP1)** is the value output by the voltage converter at its span end (e.g. 8,8 V DC).

This is applicable accordingly for pages **Line conductor 2 and 3**.



5.2 Channel data

5.2.1 Controller

Name	Description	Value	on	Range
<b>Cntr</b>	<b>Controller</b>			
Pb1	proportional band 1 [phys]	100.0		0.100...3200
Pb2	proportional band 2 [phys]	100.0		0.100...3200
ti1	integral action 1 [s]	off	<input type="checkbox"/>	1.000...3200
ti2	integral action 2 [s]	180.0	<input checked="" type="checkbox"/>	1.000...3200
td1	derivative action 1 [s]	180.0	<input checked="" type="checkbox"/>	1.000...3200
td2	derivative action 2 [s]	180.0	<input checked="" type="checkbox"/>	1.000...3200
t1	min. cycle time 1 [s]	10.00		0.400...3200
t2	min. cycle time 2 [s]	10.00		0.100...3200
tP	min. pulse length [s]	off		0.100...3200
t.on	puls water cooling [s]	0.100		0.100...3200
t.oFF	min. pulse pause [s]	2.000		1.000...3200
F.H2O	characteristic watercooling	0.500		0.100...3200
E.H2O	min. temperature [phys]	120.0	<input checked="" type="checkbox"/>	-3000...3200
SH	neutral zone [phys]	2.000		0.000...3200
HYS.L	hysteresis low [phys]	1.000		0.000...3200
HYS.H	hysteresis high [phys]	1.000		0.000...3200
tt	motor travel time [s]	60.00		3.000...3200
d.SP	additional contact D / Y [phys]	-100.00		-3200...3200
Y2	correcting variable 2	0.000		-100.0...100.0
Y.Lo	lower output range [%]	-100.0		-105.0...99.00
Y.Hi	upper output range [%]	100.0		-99.00...105.0
Y.O	working point [%]	0.000		-100.0...100.0
Ym.H	max. mean value [%]	5.000		-100.0...100.0
L.Ym	max. deviation mean [phys]	8.000		0.100...3200
Y.St	start-up actuating value	20.00		-100.0...100.0
F.Yop	factor for pulse height	1.000		-10.00...10.00
T.Pir	Attention time process rest	1000		1...1000
O.Hk	pulse attempt	0: Active process		

For better clarity, all parameters are shown in the figure, although some parameters are mutually precluding in practical applications.

This page provides a list of the controller-related parameters the values of which can be specified in column "Value". The limits of adjustment are specified in column "Range".

Parameters which can be switched off must be activated in column "on" before input of the value.

For switching off, the specified value must be set to "off". Internally, "off" means the parameter is set to value 32000.

The unit is specified in square brackets:

**[phys]** means that this value is specified in units of the physical quantity configured for this controller. If the controller is connected to a thermocouple, for instance, and the unit is °C, the proportional band must also be specified in °C. With a controller designed for pressure control (via a transmitter), the unit of the proportional value is bar.

**[s], [min]** means second or minute.

**[%]** is the percentage which limits this parameter.

With three-point stepping controllers (heating/cooling), parameters with index 1 relate to heating and parameters with index 2 relate to cooling. With three-point stepping controllers, index 1 is valid for direction "OPEN" and index 2 is valid for direction "CLOSED".

**Caution!!! The parameters can be exchanged, if required by the motor actuator connection.**

### 5.2.1.1 Proportional band

**Proportional band 1 (Pb1)** Proportional band of the controller for heating, or OPEN

**Proportional band 2 (Pb2)** Proportional band of the controller when cooling, or CLOSED

### 5.2.1.2 Integral action time

**Integral action 1 [s] (ti1)** Controller integral action time for heating, or OPEN

**Integral action 2 [s] (ti2)** Controller integral action time for cooling, or CLOSED

### 5.2.1.3 Derivative action time

**Derivative action 1 [s] (td1)** Controller derivative action time for heating, or OPEN

**Derivative action 2 [s] (td2)** Controller derivative action time for cooling, or CLOSED

Parameters ti and td can be switched off, i.e. the controller action is PD with ti switched off and PI with td switched off. With ti and td switched off, a pure P controller is defined.

**5.2.1.4 min. cycle time 1 [s] (t1)** is the minimum duration of a duty cycle (on/+ off time) for heating, or OPEN

**5.2.1.5 min. cycle time 2 [s] (t2)** is the minimum duration of a duty cycle (on/+off time) for cooling, or CLOSED

**5.2.1.6 min. pulse length [s] (tP)** is the minimum length of a pulse for heating and cooling, or OPEN and CLOSED. This setting is important when using electromechanical switching elements (contactors), or with big-sized motor actuators, which need a defined duty cycle before reacting.

**Control parameters  $T_N$  and  $T_V$  for the cooling controller**

The differences between the dynamic conditions for the heating process and the cooling process are very significant. For this reason, independent parameters for heating ( $X_{P1}$ ,  $T_{N1}$ ,  $T_{V1}$ ) and cooling ( $X_{P2}$ ,  $T_{N2}$ ,  $T_{V2}$ ) are determined during self-tuning with three-point stepping controllers. Switch-over is automatic at zero correcting variable with a hysteresis of 2 % symmetrical to zero.

The following 4 parameters relate to controllers with water cooling (water evaporation). For a detailed parameter description, see chapter "Water cooling".

- 5.2.1.7 Puls water cooling [s] (t.on)** With water cooling, the duration of the water pulse is adjustable in this line. This value is largely machine-dependent (size of evaporation surface, response time of solenoid valve, water temperature...) and can be determined only by testing.
- 5.2.1.8 Min. pulse pause [s] (t.off)** This is the minimum time between two water cooling pulses. This value is largely machine-dependent (size of evaporator surface, response time of solenoid valve, water temperature...) and can be determined only by testing.
- 5.2.1.9 Characteristic watercooling (F.H20)**  
The non-linear water cooling characteristic is adapted in this item.
- 5.2.1.10 Min. temperature [phys] (E.H20)** Adjust the min. temperature limit at which watercooling should start. As watercooling works with evaporation, adjusting temperatures below 100 °C is not purposeful.
- 5.2.1.11 Neutral zone/hysteresis [phys] (SH)** The neutral zone is a symmetrical zone around the set-point, in which the controller "does not do anything". To protect the switching elements and to keep the process value stable, this value should not be too small. The value should be determined by testing.
- 5.2.1.12 Hysterese Low [phys] (HYS.L)**
- 5.2.1.13 Hysterese High [phys] (HYS.H)**

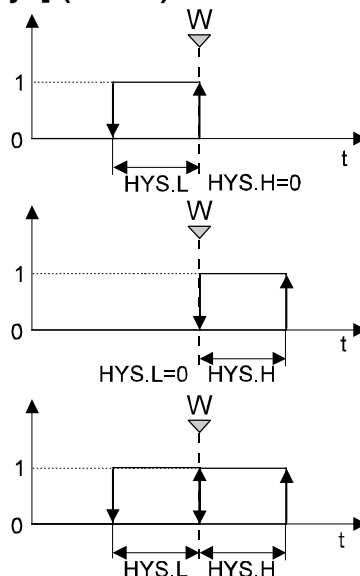





### 5.3 Parameter set 2

The process parameters may be different dependent on the process conditions. Some alloys used as heating material cause differences of the heating behaviour at low temperatures (e.g. when heating up) and near the working point (set-point). For this reason, each controller in the KS Vario system is provided with 2 parameter sets: 0 and 1. These parameter sets are completely independent and can be optimized, processed and activated individually or in groups. Changeover between the parameter sets is either via the field bus (PLC) or via a control input of a digital input module.

#### 5.3.1 Parameter set 2 (PAR2)

Name	Description	Value	on	Range
<b>PAR2</b>	<b>Parameter set 2</b>			
Pb12	proportional band 1 [phys]	100.0		0.100...3200
Pb22	proportional band 1 [phys]	100.0		0.100...3200
ti12	integral action 1 [s]	180.0	<input checked="" type="checkbox"/>	1.000...3200
ti22	integral action 2 [s]	180.0	<input checked="" type="checkbox"/>	1.000...3200
td12	derivative action 1 [s]	180.0	<input checked="" type="checkbox"/>	1.000...3200
td22	derivative action 2 [s]	180.0	<input checked="" type="checkbox"/>	1.000...3200

On this page, the 2nd process parameter set can be specified. Input via self-tuning is also possible.

Activation of this parameter set is described in **Configuration -> Channel -> Logic -> Pid2**

### 5.4 Inputs

Name	Description	Value	Range
<b>InP</b>	<b>Input</b>		
InL	lower input value 6 [phys]	4.000	-3000...3200
OuL	lower output value 6 [phys]	0.000	-3000...3200
InH	upper input value 6 [phys]	20.00	-3000...3200
OuH	upper output value 6 [phys]	250.0	-3000...3200
t.F	filter time 6 [s]	0.500	0.000...100.0
OffTk	offset of TC [phys] 6		

This page is intended to specify standard signal input scaling in units of the physical quantity. The page is accessible only with 2. Scaling selected in **Configuration**.

#### 5.4.1 lower input value 1 (InL) Lower transmitter output value (span start as an electric signal, e.g. 4 mA).

## Functional-Description KS vario

---

- 5.4.2 lower output value 1 (OuL)** Value in units of the physical quantity, which corresponds to the input span start. Physical value, e.g. 0 t)
- 5.4.3 upper input value 1 (InH)** Upper transmitter output value (span end as an electric signal, e.g. 20 mA).
- 5.4.4 upper output value 1 (OuH)** Value in units of the physical quantity, which corresponds to the input span end. Physical value, e.g. 10 t)
- 5.4.5 Filter time 1 [s] (tF)** For suppression of interference on the input leads, each controller is provided with an adjustable digital input filter. (This filter is equivalent to the R-C protective circuit of former analog controllers.) Short filter times permit quick response to process value changes, however, they offer only insufficient suppression of external interference. Filter time constants offer good protection against interference, however, control is slowed down with fast process changes. The setting is dependent on the interference in the environment and should be as low as possible.
- 5.4.6 Offset of Tk 1** The installation of a KS VARIO station near a heat source may cause a temperature compensation offset. This error can be compensated by means of an entry in this line. Positive and negative entries are possible.

### 5.5 Setpoint

Name	Description	Value	on	Range
<b>Setp</b>	<b>Setpoint</b>			
SP.LO	lower setpoint range [phys]	0.000		-3000...3200
SP.Hi	upper setpoint range [phys]	900.0		-3000...3200
SP.2	2nd setpoint [phys]	0.000		-3000...3200
rSP	setpoint ramp [/min]	off	<input type="checkbox"/>	0.010...3200
SP.bo	boost increasing [phys]	30.00		-3000...3200
t.bo	boost duration [min]	10.00		0.000...3200
SP.St	setpoint for start-up [phys]	95.00		-3000...3200
t.St	start-up time [min]	10.00		0.000...3200
Gef	Controlled heat-up	0: sto...		

All values related to the setpoint are entered on this page.

- 5.5.1 lower setpoint range [phys] (SP.LO)** This value determines the lower limit for setpoint adjustment. Adjusting a setpoint lower than this limit is not possible.
- 5.5.2 upper setpoint range [phys] (SP.Hi)** This value determines the upper limit for setpoint adjustment. Adjusting a value higher than this limit is not possible.

(The above settings correspond to the mechanical stops of analog controllers.)

These two values determine the setpoint adjustment range. It may be the boost or the output of a master controller.

The 2nd setpoint is not affected by this limiting. Regardless of these limits, any value can be adjusted.

As default values, the limits of the sensor measuring range are used. For reasons of safety and self-tuning, the upper setpoint limit should be as low as possible. (Self-tuning starts only with a min. separation of 10 % of "upper setpoint range" minus "lower setpoint range" between the instantaneous process value and the adjusted setpoint.

**5.5.3 2nd setpoint [phys] (SP.2)** Generally, this 2nd setpoint is used to keep the machine/installation at a lower temperature level in longer operation pauses (stand-by operation). The 2nd setpoint can be switched on and off by a digital signal (if configured) or via the fieldbus. There is no time limit for the 2nd setpoint. With a value higher than the adjusted setpoint limits, these limits are also applicable to the 2nd setpoint.

**5.5.4 Setpoint ramp [/min] (r.SP)** This gradient is used for slow (gentle) line-out to the setpoint, independent of the process speed. (The setpoint is increased dependent on time! The process value follows at the process speed.)  
By clicking on checkbox "on", a setpoint ramp is permitted and the entry in column "value" determines the setpoint rate of increase.  
Once the setpoint gradient is permitted, the value can be varied during operation (via the field bus).

**5.5.5 Boost increasing [phys] (SP.bo)** The boost function is intended for time-limited setpoint shifting. Although "boost increasing" might suggest an increase in positive direction, negative values can also be adjusted, because the process output action can also be "direct".

**5.5.6 Boost duration [min] (t.bo)** The boost duration determines the boost duration.

The two boost values are machine-dependent. Consequently, a recommendation for the adjustable values is not possible.

### **5.5.7 Start-up circuit**

Delicate processes may require slow heat-up. E.g. hot-runner processes: These heating cartridges are provided with hygroscopic insulating material and the heating energy as compared to the mechanical size is very high. Applying the full energy to such a heating element would cause a very quick temperature increase, i.e. the humidity would evaporate immediately and the heating cartridge would explode. The start-up circuit with adjustable parameters max. correcting variable after start up to the start-up setpoint, the start-up setpoint and the start-up time provide effective protection against overheating.

**5.5.8 Setpoint for start-up [phys] (SP.St)** With activated start-up circuit, this entry is the setpoint for control by means of a defined reduced correcting variable.

**5.5.9 Start-up time [min] (t.St)** This time determines, how long the start-up setpoint should be held.

The start-up parameters are dependent on the mould, or on the machine.

After elapse of the start-up time, the start-up circuit is switched off. However, it is re-activated, when the process value falls by 40° C/F below the start-up setpoint.

The start-up circuit is also activated, if the (normal) setpoint is below the start-up setpoint (faulty adjustment). In this case, "start-up" is with the normal setpoint. After elapse of the start-up time, nothing will happen. When increasing the setpoint above the start-up



setpoint, the limited correcting variable is used for control to the start-up setpoint and the normal setpoint is activated after elapse of the start-up time.

### 5.6 Controlled setpoint tracking

This "automatic" temperature ramp function prevents mechanical stress in a group of control zones, which can be due to differences in the heat-up speed. KS VARIO automatically determines the zone with the lowest rate of increase for even control to the adjusted setpoints. This is independent of the current process values, i.e. already warmed up control zones at higher temperature level wait for the remaining zones for common controlled heat-up.

Analogous to controlled heating, controlled cooling is also possible!

First of all, definition if the controlled setpoint tracking function should or shouldn't be used for this zone (channel) is required for each channel.

#### 5.6.1 Controlled setpoint tracking (Gef)

**0: no tracking** The channel does not participate in controlled setpoint tracking.

**1: tracking** The channel participates the controlled setpoint tracking, i.e. the channel belongs to the group which reaches the setpoint in common with the least significant process value differences.

The trigger signal **Gef.Sig** controls the tracking function:

**0: inactive**

**1: up** (heating with tracking)

**2: down** (cooling with tracking)

The signal can be operated via the field bus interface or via the engineering tool.  
(**Operating -> Overview -> Leaded setpoint**)

Subsequently, the new setpoints for heating or cooling can be input.

The signal is reset automatically (inactive), as soon as only max. zone with controlled setpoint tracking is still not lined out.

Automatic reset of the trigger signal (heating with tracking or cooling with tracking) occurs at the earliest after one minute. This delay time is necessary to activate the tracking function from the lined out condition. The user has a bit of time to change the setpoints without terminating the tracking function automatically.

#### 5.6.2 Internal realization

The controlled setpoint tracking function is realized internally by means of lead setpoints changing towards the (target) setpoints. When activating the tracking function, the channel process values are checked.

The further description relates to up (heating), down (cooling) is done analogously.

## Functional-Description KS vario

---

The lead setpoint is fixed to the instantaneously most distant process value plus delta (**Gef.Del**) (default setting: 5,0 [without unit]), see **Gef.Del**.

### *Assumption: A*

A channel process value is higher than the target setpoint: the channel is lined out to the new target setpoint. Cooling is possible with a three-point controller (heating/cooling).

### *Assumption B:*

A channel process value is lower than the lead setpoint: the lead setpoint is used as effective setpoint for the channel.

### *Assumption C:*

A channel process value is between lead setpoint and target setpoint: the effective setpoint of this channel is set to the channel process value at the time of activation of the controlled setpoint tracking (towards the target setpoint) function. This setpoint is held, until overtaken by the lead setpoint in target setpoint direction. Whilst being held, the channel may control freely (cooling is also possible).

After activating the controlled setpoint tracking function, all effective setpoints are only changed in target setpoint direction.

When reaching the target setpoint, controlled setpoint tracking is switched off: signal **Gef.Sig** is set to "0". As long as the controller is not switched off, controlled setpoint tracking does not restart automatically, even in case of a setpoint change by more than delta (**Gef.Del**) for the max. process value deviation. In such a case, the controlled setpoint tracking must be switched on first before changing the setpoints of min. 2 controllers within a minute (higher than the value in **Gef.Del**).

The time of 1 minute within which signal **Gef.Sig** remains set gives the user the opportunity to change the setpoints: with the machine lined out and all process values within the limits, detection that all process values and setpoints are equal would take place immediately and the controlled setpoint tracking function would be switched off (because the switch-off conditions are met). A setpoint increase of min. 2 channels would be done without tracking.

At controller power-on, signal (**Gef.Sig**) cannot be set externally before controller start-up, because the controller still did not start communicating. In this case, KS VARIO generates signal "heating with tracking" during one minute, to prevent the tracking signal from being late.

When the controlled setpoint tracking function is not required any more, the signal can be redeleted at any time (via field bus or engineering tool).

### 5.6.3 Offset of lead setpoint [-] (Gef.Del)

Name	Description	Value	Range
<b>Allg</b>	<b>General</b>		
Gef.Del	Offset of lead setpoint [phys.]	5.000	0.100...3000

The offset is the value by which the most distant process value is changed in target setpoint direction. This value is used as setpoint for all controllers participating in controlled setpoint tracking. The offset is without dimension, i.e. processed in the dimension configured for the instrument. Default setting: 5,0 [-].

Channels at the setpoint (target setpoint  $\pm$  Delta), with Fail or OFF are controlled directly by means of the target setpoint. With higher delta, line-out to the target setpoint is earlier, however, the process value deviations between all channels may be a bit higher. Input of **Gef.Del** is in **Parameter -> Device -> General**

### 5.6.4 Priorities with controlled setpoint tracking

With active controlled setpoint tracking and other settings which influence the setpoint, the priorities are:

#### **Controlled setpoint tracking and start-up circuit**

The start-up setpoint is reached using the controlled setpoint tracking function by means of the value adjusted in "start-up actuating value". After elapse of the start-up time, control to the main setpoint is also with tracking.

#### **Controlled setpoint tracking and boost**

As the controlled setpoint tracking function was already switched off (all zones have reached the target setpoint), boost is without tracking.

#### **Controlled setpoint tracking and setpoint ramp**

Control to the target setpoint is with tracking and using the maximum correcting variable adjusted in "setpoint ramp".

5.6.5 Limit (values) (Lim)

Name	Description	Value	on	Range
<b>Lim</b>	<b>Limit</b>			
L.1	lower limit 1 [phys]	-10.00	<input checked="" type="checkbox"/>	-3000...3200
H.1	upper limit 1 [phys]	10.00	<input checked="" type="checkbox"/>	-3000...3200
HYS.1	hysteresis 1 [phys]	1.000		0.000...3200
L.2	lower limit 2 [phys]	40.00	<input checked="" type="checkbox"/>	-3000...3200
H.2	upper limit 2 [phys]	10.00	<input checked="" type="checkbox"/>	-3000...3200
HYS.2	hysteresis 2 [phys]	1.000		0.000...3200
L.3	lower limit 3 [phys]	off	<input type="checkbox"/>	-3000...3200
H.3	upper limit 3 [phys]	off	<input type="checkbox"/>	-3000...3200
HYS.3	hysteresis 3 [phys]	1.000		0.000...3200

Max. 3 limit values can be assigned to each KS VARIO controller (**L1**, **L2**, **L3**).  
 The values can be adjusted on this page. The type of limit signalling (relative or absolute alarm, with/without storing...) was adjusted already on page **Configuration -> Limit values (Lim)**.

5.6.5.1 Lower limit 1 [phys] (**L1**)

5.6.5.2 Upper limit 1 [phys] (**H1**)

If the values specified in this item are exceeded, an alarm is output. The entries are selectable freely and not limited (sensor measuring range, setpoint range...).

**Absolute alarm:** With this alarm type, the entry is handled as an absolute value, i.e. the alarm value remains unchanged, regardless of the adjusted setpoint. The entry made in **L1** does not mean that this alarm is automatically below the setpoint. Values above the setpoint are also possible. The same applies analogously to the value in **H1**.

**Relative alarm:** This type of alarm is a deviation related to the setpoint. The alarm point is shifted when changing the setpoint. The entry in **L1** does not mean that this alarm is automatically below (Low) the setpoint. In order to make this entry an alarm below the setpoint, it must have a "minus" sign. Therefore, 2 low, 2 high, or 1 low and 1 high alarm are possible for an alarm.

The same applies analogously to the value in **H1**.

## 6 Bus data transmission (only for PROFIBUS)

(see also PROFIBUS-DP interface description (9499 040 69718))

This selection of the data to be transmitted is valid only for the PROFIBUS, also if it still seems to be accessible for the Modbus presently.

For data exchange via the PROFIBUS, a mechanism accessible via window *Parameter* was created. In the header of this window, a listbox with the following options is opened when clicking on the line:

*Parameter*  
*Bus data (read)*  
*Bus data (write)*  
*Bus data (read group)*  
*Bus data (write group)*

Select the data to be transmitted via the PROFIBUS from the four options "Bus data...".

### 6.1 Single data transmission

*Bus data (read)* means that the data on this list can only be read by the PLC. We recommend using this option, when only few data should be read.

Analogously, *Bus data (write)* is used for writing bus data into the KS Vario station.

For reading and writing, data must be specified in both categories.

The number of data to be transmitted in this "single mode" is limited to 120.

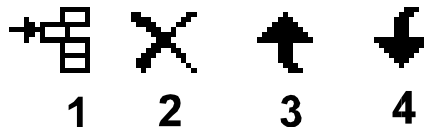

Select the data category of the datum to be transmitted from the tree on the left side. Select and click on the icon (1) to include this datum into the list of data to be transmitted. For deleting a datum from the list, select it and click on icon (2) to remove it. For this purpose, the data group from which this datum was selected need not be open. For clarity reasons, these data can also be sorted, i.e. data can be shifted (3) and (4).

The data in this selection field are displayed partly in black or in gray. Only transmission of black data makes sense for the existing system configuration. Gray data are not used in this system, however, they can be included in the list.

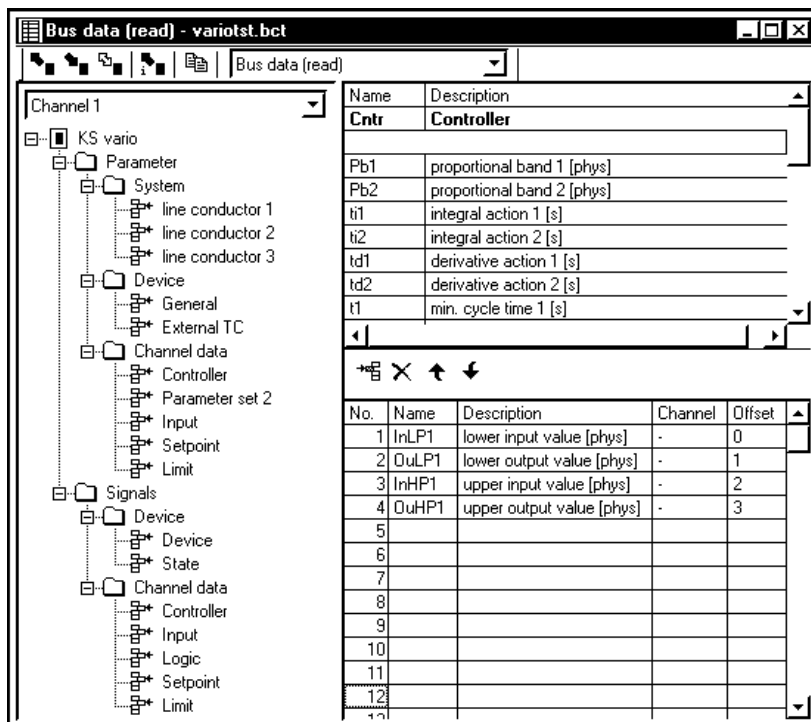

Column signification:

- No.: number of the data to be transmitted
- Name: short name of datum
- Description: full name of datum
- Channel: channel number for which this datum is transmitted. Unless a channel number is specified, it is an instrument datum.
- Offset: The address of this datum is obtained by increasing the basic address by the offset. The first datum is the basic address, offset=0.

## 6.2 Group data transmission

Group transmission of bus data is intended to facilitate the selection of data to be transmitted with larger sized systems.

With **Bus data (read group)** or **Bus data (write group)** all 30 data of this type are always transmitted.

This method is used for transmission of all selected data of all 30 (possible) controllers/channels, independent of whether they are or are not used.

Data transmission is controller-related. I.e. all data (in the order of listing) of controller 1 are transmitted first, then all data of controller 2 are transmitted, etc.

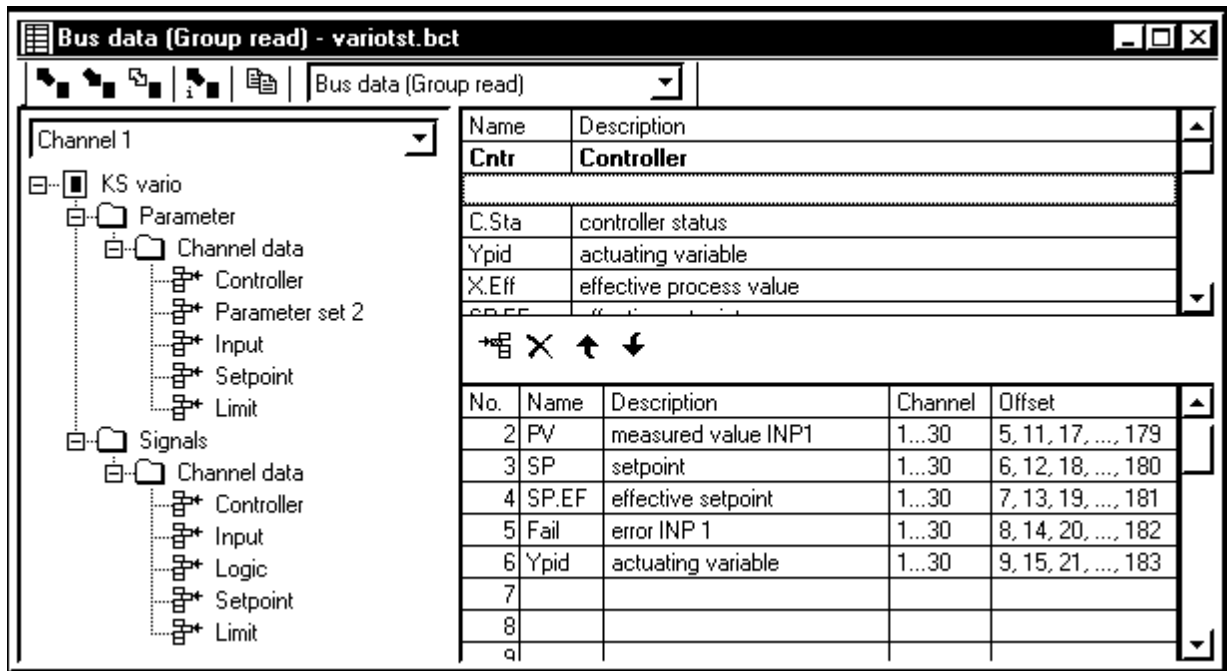

In the example, transmission includes (order of time):

- Xphys controller 1 raw measured value
- PV controller 1 corrected measured value
- SP controller 1 set-point
- SP.EF controller 1 effective set-point (after any ramp function)
- Fail controller 1 (sensor) error
- Ypid controller 1 correcting variable

- Xphys controller 2 raw measured value
- PV controller 2 corrected measured value
- SP controller 2 set-point
- SP.EF controller 2 effective set-point (after any ramp function)
- Fail controller 2 (sensor) error
- Ypid controller 2 correcting variable

...

- Xphys controller 30 raw measured value
- PV controller 30 corrected measured value
- SP controller 30 set-point
- SP.EF controller 30 effective set-point (after any ramp function)
- Fail controller 30 (sensor) error
- Ypid controller 30 correcting variable

Only channel/controller data can be used for group transmission. Instrument data must be transmitted individually.

## Functional-Description KS vario

---

Single data and group data are always grouped into a transmission block: read and write.

The single data start with offset 0 and the group data follow directly without space after the last single address.

With subsequent extension of single transmission, all addresses in the control program would have to be changed. For this reason, some "dummy transmissions" after the last single address are purposeful. In case of extension of single transmission, these can be overwritten without changing the following addresses.

"Dummy transmissions" can be:

1. data which are not required for this application; e.g. when using 2 or 3-point controllers, the travel time for the actuator, or other data shown in "gray" in the example are transmitted.
2. Or single (required) data are transmitted several times.





