

VARIO AI 8/SF

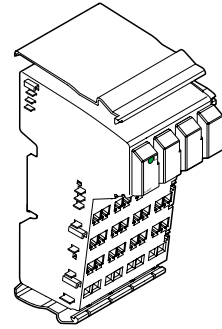

I/O Extension Module With Eight Analog Input Channels



User Manual

11/2001

62260001



This data sheet is only valid in association with the documents of the used fieldbus coupler

Function

The terminal is designed for use within an VARIO station. It is used to measure analog voltage or current signals.

Features

- Eight analog single-ended signal inputs for the connection of either voltage or current signals
- Sensors are connected using 2-wire technology
- Various current and voltage measuring ranges
- Channels are configured independently of one another using the field-bus
- Measured values can be represented in five different formats
- 16-bit analog-to-digital converter
- Process data multiplex operation
- Diagnostic indicators

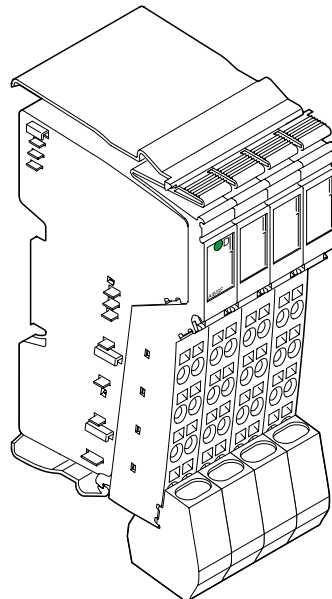

6226A002

Figure 1 VARIO AI 8/SF with connectors



All modules will be delivered including connectors and labeling fields

Table of Contents

Function	1
Table of Contents	2
Installation Instructions	3
Internal Circuit Diagram	4
Electrical Isolation	5
Connection Notes	5
Connection Examples	6
Programming Data	6
Process Data Words	7
Process Data Output Words OUT[0] and OUT[1]	8
Process Data Input Words IN[0] and IN[1]	12
Formats for Representation of Measured Values	17
Process Data Input Words in the Event of an Error	30
Startup Options	31
Application Notes	38
Tolerance and Temperature Response	41
Technical Data	43
Ordering Data	46

Local Diagnostic Indicators and Terminal Assignment

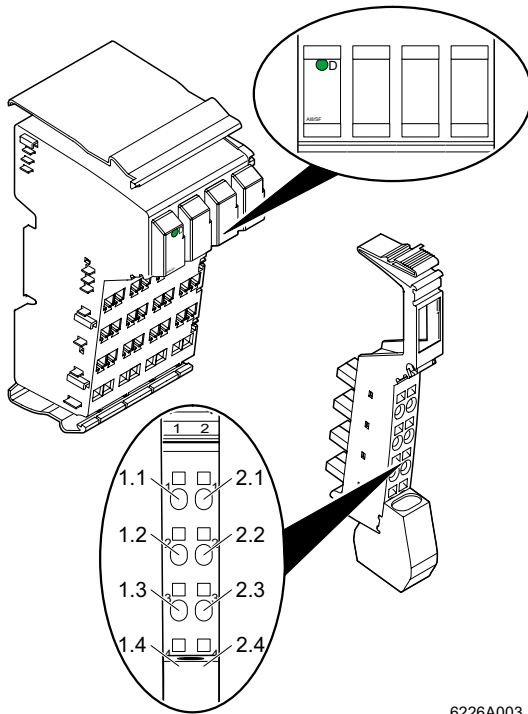

6226A003

Figure 2 VARIO AI 8/SF with an appropriate connectors

Local Diagnostic Indicators

Des.	Color	Meaning
D	Green	Bus diagnostics

Terminal Assignment for Each Connector

Terminal Points	Signal	Assignment
1.1	+U1	Voltage input channel 1
2.1	+U2	Voltage input channel 2
1.2	+I1	Current input channel 1
2.2	+I2	Current input channel 2
1.3, 2.3	-1, -2	Minus input (for both current and voltage)
1.4, 2.4	Shield	Shield connection

Installation Instructions

High current flowing through potential jumpers U_M and U_S causes the temperature of the potential jumpers and the internal temperature of the terminal to increase. Observe the following instructions to keep the current flowing through the potential jumpers of the analog terminals as low as possible:



All of the analog terminals need a separate main circuit.

If this is not possible in your application and if you are using analog terminals in a main circuit together with other terminals, place the analog terminals behind all the other terminals at the end of the main circuit.

Internal Circuit Diagram

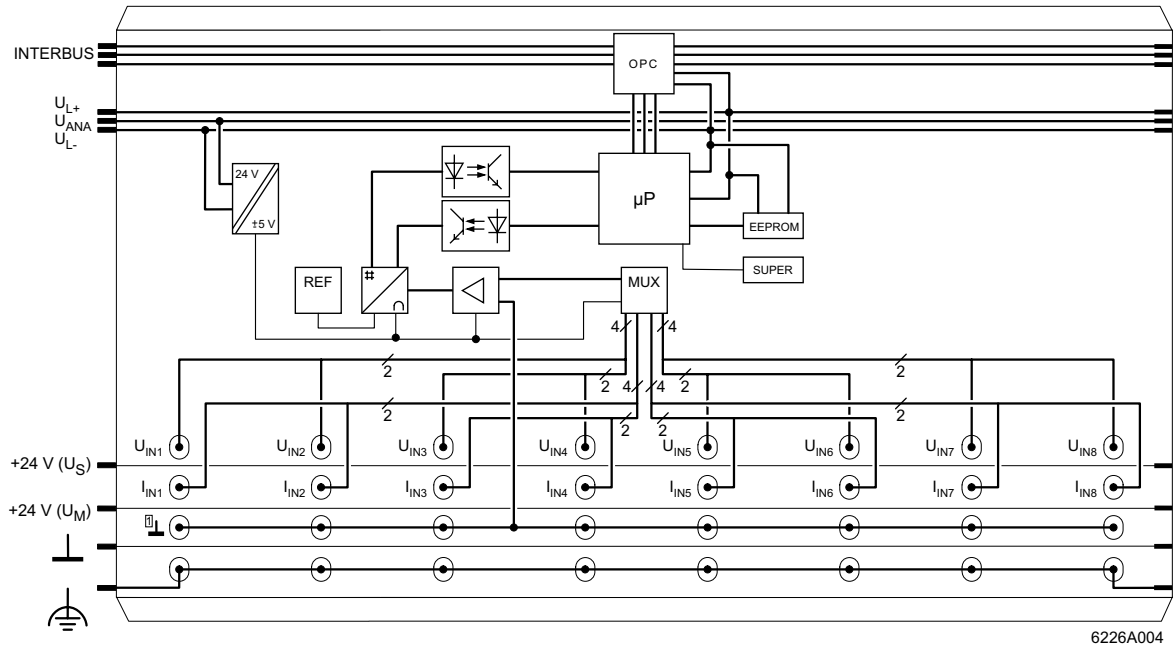











Figure 3 Internal wiring of the terminal points

Key:

	INTERBUS protocol chip		Power supply unit with electrical isolation
	Optocoupler		Reference voltage source
	Microprocessor		Analog-to-digital converter
	Electrically erasable, reprogrammable read-only memory		Amplifier
	Microprocessor monitoring		Multiplexer

Electrical Isolation

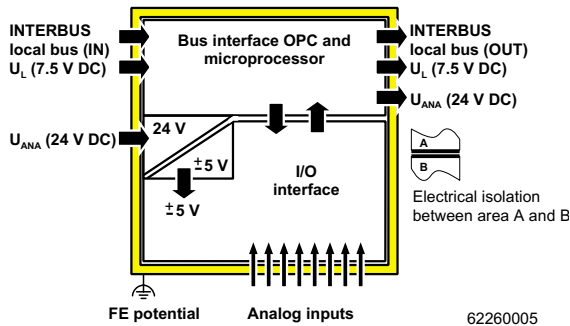

Figure 4 Electrical isolation of the individual function areas

Connection Notes



Do not simultaneously apply current and voltage signals to **one** input channel as you will not obtain valid measured values.



Do not connect voltages above ± 2.5 V to a current input. The electronics module will be damaged if the maximum permissible current of ± 100 mA is exceeded.



Always connect the analog sensors using shielded, twisted-pair cables.

Connect the shielding to the Inline terminal using the shield clamp. The clamp connects the shield directly to FE (functional earth ground) on the terminal side. Additional wiring is not required.

Isolate the shielding at the sensor or connect it with a high resistance and a capacitor to the PE potential.

Connection Examples



Observe the connection notes on page 5.

Figure 5 shows the connection schematically (without shield connector).

Connection of Active Sensors

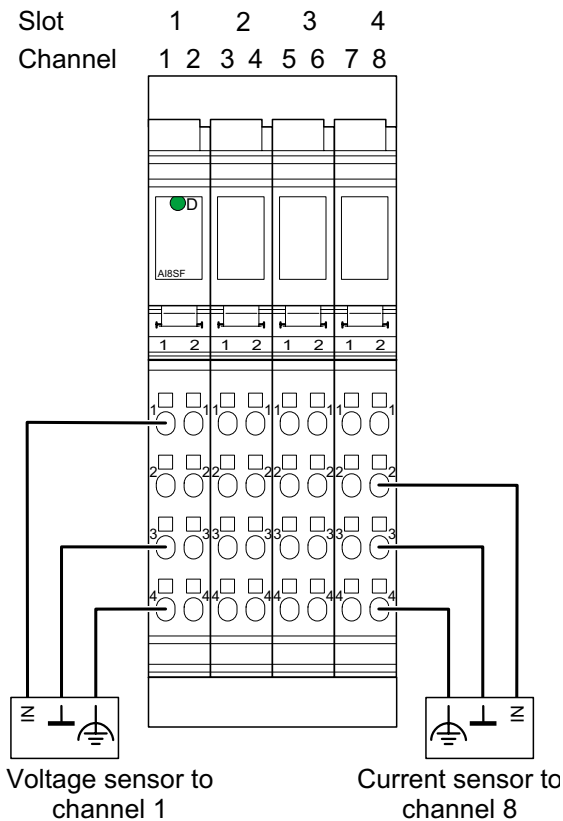

Figure 5 Connection of active sensors using 2-wire technology with shield connection



The sensors have the same reference potential.

Programming Data

ID code	5F _{hex} (95 _{dec})
Length code	02 _{hex}
Process data channel	32 bits
Input address area	4 bytes
Output address area	4 bytes
Parameter channel (PCP)	0 bytes
Register length (bus)	4 bytes

Process Data Words

Process Data Output Words for the Configuration of the Terminal (see page 8)

Process Data Output Word 0 (OUT[0])					Process Data Output Word 1 (OUT[1])				
Byte 0		Byte 1			Byte 2		Byte 3		

		OUT[0]														
(Byte.bit) view	Byte	Byte 0							Byte 1							
	Bit	7	6	5	4	3	2	1	0	7	6	5	4	3	2	1
	Assignment	0	Command						0	0	0	0	0	0	0	0

		OUT[1]														
(Byte.bit) view	Byte	Byte 2							Byte 3							
	Bit	7	6	5	4	3	2	1	0	7	6	5	4	3	2	1
	Assignment	0	0	0	0	0	0	Filter	0	Format			Measuring range			

Process Data Input Words (see page 12)

Process Data Input Word 0 (IN[0])					Process Data Input Word 1 (IN[1])				
Byte 0		Byte 1			Byte 2		Byte 3		

		IN[0]															
(Byte.bit) view	Byte	Byte 0							Byte 1								
	Bit	7	6	5	4	3	2	1	0	7	6	5	4	3	2	1	0
	Assignment	15	14	13	12	11	10	9	8	7	6	5	4	3	2	1	0
		Depends on the command															

		IN[1]															
(Byte.bit) view	Byte	Byte 2							Byte 3								
	Bit	7	6	5	4	3	2	1	0	7	6	5	4	3	2	1	0
	Assignment	15	14	13	12	11	10	9	8	7	6	5	4	3	2	1	0
		Depends on the command															

Process Data Output Words OUT[0] and OUT[1]

The terminal must be configured using the two process data output words. The word OUT[0] contains the command and the word OUT[1] contains the parameters for this command.

The following configurations are possible:

- Selecting a measuring range according to the input signal
- Selecting the mean-value generation (filtering)
- Changing the formats for the representation of measured values

 Current or voltage measurement is selected by applying the measured signal to the current or voltage input and then configuring the measuring range.



After applying voltage (power up) to the Inline station, the message "Measured value invalid" (diagnostic code 8004_{hex}) appears in the process data input words for every channel scanned. The message is displayed until the appropriate channel has been configured.

If the configuration is changed, the message "Measured value invalid" (diagnostic code 8004_{hex}) appears for a maximum of 100 ms.



Please note the extended runtime when a channel is configured for the first time and every time a channel is reconfigured.

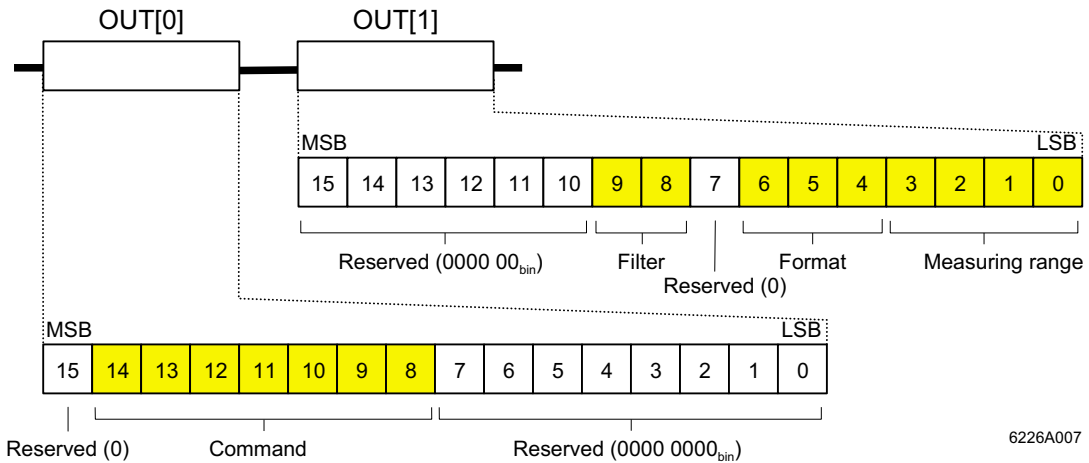



Figure 6 Process data output words

MSB Most significant bit

LSB Least significant bit

 Set all reserved bits to 0.

OUT[0] (Command Code)

	OUT[0]																
Bit	15	14	13	12	11	10	9	8	7	6	5	4	3	2	1	0	
Assignment	0	Command							0	0	0	0	0	0	0	0	0

Bit 15 to bit 8 (command):

Bit 15 to Bit 8								OUT[0]	Command Function
0	0	0	0	0	Z ₂	Z ₁	Z ₀	0x00 _{hex}	Read measured value of channel x
0	0	0	1	0	Z ₂	Z ₁	Z ₀	1x00 _{hex}	Read configuration of channel x
0	0	1	1	1	1	0	0	3C00 _{hex}	Read firmware version and module identification
0	1	0	0	0	Z ₂	Z ₁	Z ₀	4x00 _{hex}	Configure channel x
0	1	0	1	0	Z ₂	Z ₁	Z ₀	5x00 _{hex}	Configure channel x and read measured value of channel x
0	1	1	0	0	0	0	0	6000 _{hex}	Configure entire terminal (all channels)
0	1	1	1	0	Y	Y ₁	Y ₀	7x00 _{hex}	Commands for groups without mirroring

Z₂ Z₁ Z₀ Channel number

Y₂ Y₁ Y₀ Group number

	OUT[0]																
Bit	15	14	13	12	11	10	9	8	7	6	5	4	3	2	1	0	
Assignment	0	Command							0	0	0	0	0	0	0	0	0
Channel/group	0	X	X	X	X	X	X	X	0	0	0	0	0	0	0	0	

Bit 10 to bit 8 (channel number Z₂Z₁Z₀ or group number Y₂Y₁Y₀):

Code		Channel	Code		Group
bin	dec		bin	dec	
000	0	1	000	0	4 x 8-bit group A (channel 1, 2, 3, and 4)
001	1	2	001	1	4 x 8-bit group B (channel 5, 6, 7, and 8)
010	2	3	010	2	Reserved
011	3	4	011	3	Reserved
100	4	5	100	4	2 x 16-bit group A (channel 1 and 2)
101	5	6	101	5	2 x 16-bit group B (channel 3 and 4)
110	6	7	110	6	2 x 16-bit group C (channel 5 and 6)
111	7	8	111	7	2 x 16-bit group D (channel 7 and 8)

OUT[1] (Parameter Word)

The parameters for the commands $4x00_{hex}$, $5x00_{hex}$, and 6000_{hex} must be specified in OUT[1]. This parameter word is only evaluated for these commands.

		OUT[1]															
Bit		15	14	13	12	11	10	9	8	7	6	5	4	3	2	1	0
Assignment		0	0	0	0	0	0	Filter	0		Format		Measuring range				



If invalid parameters are specified in the parameter word, the command will not be executed. The command is confirmed in the input words with the set error bit.

Bit 9 and bit 8:

Code		Filter (Filtering by Mean-Value Generation)
bin	dec	
00	0	16-sample average (default)
01	1	No mean-value generation
10	2	4-sample average
11	3	32-sample average

Bit 6 to bit 4:

Code		Format
bin	dec	
000	0	IB IL (15 bits) (default)
001	1	IB ST (12 bits)
010	2	IB RT (15 bits)
011	3	Standardized display
100	4	PIO (for the 4 mA to 20 mA range only)
101	5	Reserved
110	6	
111	7	

Bit 3 to bit 0:

Code		Measuring Range (Voltage)
bin	dec	
0000	0	0 V to 10 V (default)
0001	1	±10 V
0010	2	0 V to 5 V
0011	3	±5 V
0100	4	0 V to 25 V
0101	5	±25 V
0110	6	0 V to 50 V
0111	7	Reserved

Code		Measuring Range (Current)
bin	dec	
1000	8	0 mA to 20 mA
1001	9	±20 mA
1010	10	4 mA to 20 mA
1011	11	Reserved
1100	12	0 mA to 40 mA
1101	13	±40 mA
1110	14	Reserved
1111	15	Reserved



The differential voltage between different terminal inputs must not exceed 50 V.

If, for example, the 0 V to 50 V range is used on one channel, the use of bipolar ranges is **not permitted** on any other channel.

Process Data Input Words IN[0] and IN[1]

The measured values and diagnostic messages (diagnostic codes) are transmitted to the controller board or computer using the two process data input words. The contents of the words vary according to the command.

IN[0] and IN[1] for Commands 0x00_{hex} to 6000_{hex}

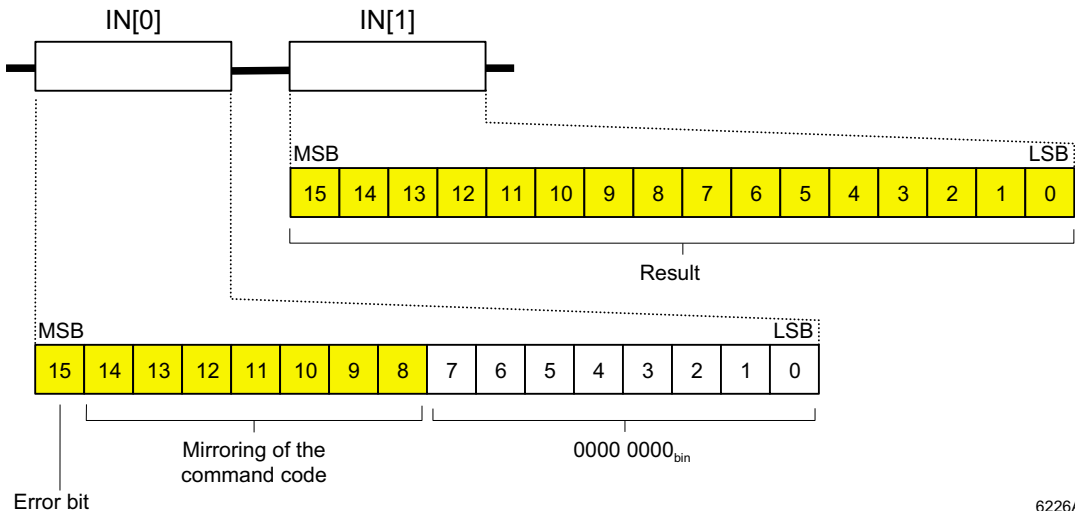

6226A008

Figure 7 Process data input words

IN[0]

The output word OUT[0], which contains the command code, is mirrored in the input word IN[0]. This confirms that the command has been executed correctly. If the command was not executed correctly, the error bit is set in bit 15 of the input word IN[0].

The error bit is set if one of the following reasons (see page 30):

- There is no valid configuration for the channel scanned
- There was an invalid parameter during configuration
- A reserved bit was set

The command is only mirrored if it has been executed completely. That means, for example, that the 5x00_{hex} command is only mirrored after the value has been read and not after reconfiguration.

IN[1]

The input word IN[1] varies depending on the command.

IN[1] contains the firmware version and module identification for the 3C00_{hex} command.

		IN[1]															
Bit		15	14	13	12	11	10	9	8	7	6	5	4	3	2	1	0
Assignment		Firmware version												Module ID			
		Example: 123 _{hex} : Terminal equipped with firmware version 1.23												6 _{hex} : AI 8/SF		3 _{hex} : AI 8/IS	

For the commands 1x00_{hex}, 4x00_{hex}, and 6000_{hex}, IN[1] contains the mirroring of the specified configuration.

		IN[1]															
Bit		15	14	13	12	11	10	9	8	7	6	5	4	3	2	1	0
Assignment		0	0	0	0	0	0	Filter		0	Format			Measuring range			

IN[0] and IN[1] for the Group-Commands 7x00_{hex}

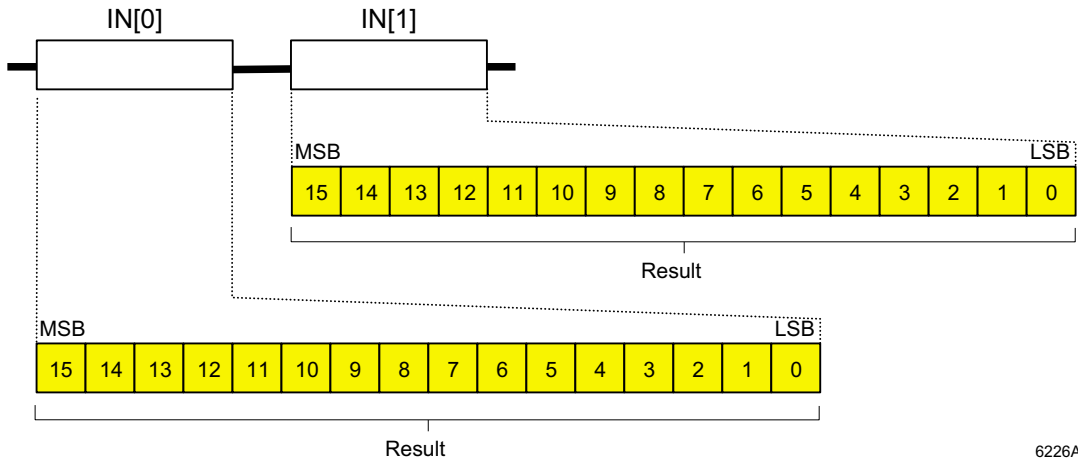

6226A013

Figure 9 Process data input words

For the group commands 7x00_{hex}, both input words contain the measured values of the channels that correspond with the group command.

Group Commands for Two 16-bit Channels: 7400_{hex}, 7500_{hex}, 7600_{hex}, and 7700_{hex}

With commands for two 16-bit channels, the analog value of one channel is mapped to every input word. The display corresponds with the display in the input word IN[1] for the 0x00_{hex} and 5x00_{hex} commands.

Example 2 x 16-Bit Group A (Channels 1 and 2): 7400_{hex} Command

	IN[0]															
Bit	15	14	13	12	11	10	9	8	7	6	5	4	3	2	1	0
Assignment	16-bit measured value channel 1 in the appropriate format															
	IN[1]															
Bit	15	14	13	12	11	10	9	8	7	6	5	4	3	2	1	0
Assignment	16-bit measured value channel 2 in the appropriate format															

Group Commands for Four 8-bit Channels: 7000_{hex} and 7100_{hex}

With commands for four channels, the analog values for two channels are mapped to every input word. The measured value for each channel is represented in eight bits. This measured value corresponds to bits 15 to 8 in the format displays of a 16-bit value.

Example 4 x 8-Bit Group A (Channels 1, 2, 3, and 4): 7000_{hex} Command

		IN[0]															
Bit		15	14	13	12	11	10	9	8	7	6	5	4	3	2	1	0
Assignment		8-bit measured value channel 1 in the appropriate format								8-bit measured value channel 2 in the appropriate format							

		IN[0]															
Bit		15	14	13	12	11	10	9	8	7	6	5	4	3	2	1	0
Assignment		8-bit measured value channel 3 in the appropriate format								8-bit measured value channel 4 in the appropriate format							



The status bits in "IB ST" format and the diagnostic messages in "IB IL" and "standardized display" format are not displayed in this configuration.

Formats for Representation of Measured Values

To ensure that the terminal can be operated in previously used data formats, the measured value representation can be switched to different formats. The "IB IL" format is the default.

Abbreviations used in the following tables:

OR Overrange

UR Under range

"IB IL" Format

The measured value is represented in bits 14 to 0. An additional bit (bit 15) is available as a sign bit.

This format supports extended diagnostics. Values $> 8000_{\text{hex}}$ and $< 8100_{\text{hex}}$ indicate an error.

The following diagnostic codes are possible:

Code (hex)	Error
8001	Overtime
8002	Open circuit
8004	Measured value invalid/no valid measured value available (e.g., because the channel was not configured)
8010	Configuration invalid
8020	I/O supply voltage faulty
8040	Module faulty
8080	Under range

Measured value representation in "IB IL" format (15 bits)

15	14	13	12	11	10	9	8	7	6	5	4	3	2	1	0
SB	Analog value														

SB Sign bit

Significant Measured Values Voltage Ranges

Input Data Word (Two's Complement)		0 V to 5 V U_{IN}	0 V to 10 V U_{IN}	0 V to 25 V U_{IN}	0 V to 50 V U_{IN}
hex	dec	V	V	V	V
8001	OR	> +5.419	> +10.837	> +27.093	> +54.187
7F00	32512	+5.419	+10.837	+27.093	+54.187
7530	30000	+5.0	+10.0	+25.0	+50.0
0001	1	+166.67 μ V	+333.33 μ V	+833.33 μ V	+1.6667 mV
0000	0	0	0	0	0
0000	0	< 0	< 0	< 0	< 0

Input Data Word (Two's Complement)		± 5 V U_{IN}	± 10 V U_{IN}	± 25 V U_{IN}
hex	dec	V	V	V
8001	OR	> +5.419	> +10.837	> +27.093
7F00	32512	+5.419	+10.837	+27.093
7530	30000	+5.0	+10.0	+25.0
0001	1	+166.67 μ V	+333.33 μ V	+833.33 μ V
0000	0	0	0	0
FFFF	0	-166.67 μ V	-333.33 μ V	-833.33 μ V
8AD0	-30000	-5.0	-10.0	-25.0
8100	-32512	-5.419	-10.837	-27.093
8080	UR	< -5.419	< -10.837	< -27.093

Current Ranges:

Input Data Word (Two's Complement)		0 mA to 20 mA I_{IN}	0 mA to 40 mA I_{IN}
hex	dec	mA	mA
8001	OR	> +21.6746	> +43.3493
7F00	32512	+21.6746	+43.3493
7530	30000	+20.0	+40.0
0001	1	+0.66667 μ A	+1.3333 μ A
0000	0	0	0
0000	0	< 0	< 0

Input Data Word (Two's Complement)		± 20 mA I_{IN}	± 40 mA I_{IN}
hex	dec	mA	mA
8001	OR	> +21.6746	> +43.3493
7F00	32512	+21.6746	+43.3493
7530	30000	+20.0	+40.0
0001	1	+0.6667 μ A	+1.3333 μ A
0000	0	0	0
FFFF	-1	-0.6667 μ A	-1.3333 μ A
8AD0	-30000	-20.0	-40.0
8100	-32512	-21.6746	-43.3493
8080	UR	<-21.6746	<-43.3493

Input Data Word (Two's Complement)		4 mA to 20 mA I_{IN}
hex	dec	mA
8001	OR	> +21.339733
7F00	32512	+21.339733
7530	30000	+20.0
0001	1	+4.00053333
0000	0	+4.0 to 3.2
8002	Open circuit	<+3.2

"IB ST" Format

The measured value is represented in bits 14 to 3. The remaining 4 bits are sign, measuring range, and error bits.

This format corresponds to the data format used on INTERBUS ST modules.

Measured value representation in "IB ST" format (12 bits):

15	14	13	12	11	10	9	8	7	6	5	4	3	2	1	0
SB	Analog value												0/4	OC	OR

SB	Sign bit	OC	Open circuit
0/4	4 to 20 mA measuring range	OR	Overrange/under range

Significant Measured Values

Voltage Ranges

Input Data Word (Two's Complement)		0 V to 5 V U_{IN}	0 V to 10 V U_{IN}	0 V to 25 V U_{IN}	0 V to 50 V U_{IN}
hex	dec	V	V	V	V
7FF9	32761	> +5.375	>+10.75	> +26.875	> +53.75
7FF8	32760	+4.9988 to +5.375	+9.9975 to +10.75	+24.9939 to +26.875	+49.9878 to +53.75
4000	16384	+2.5	+5.0	+12.5	+25.0
0008	8	1.221 mV	+2.441 mV	6.1025 mV	+12.205 mV
0000	0	< 0	< 0	< 0	< 0

Input Data Word (Two's Complement)		± 5 V U_{IN}	± 10 V U_{IN}	± 25 V U_{IN}
hex	dec	V	V	V
7FF9	32761	> +5.375	>+10.75	> +26.875
7FF8	32760	+4.9988 to +5.375	+9.9975 to +10.75	+24.9939 to +26.875
4000	16384	+2.5	+5.0	+12.5
0008	8	+1.221 mV	+2.441 mV	+6.104 mV
0000	0	0	0	0
FFF8	-8	-1.221 mV	-2.441 mV	-6.104 mV
C000	-16384	-2.5	-5.0	-12.5
8000	-32768	-5.0 to -5.375	-10.00 to -10.75	-25.0 to -26.875
8001	-32767	-5.375	<-10.75	-26.875

Current Ranges:

Input Data Word (Two's Complement)		0 mA to 20 mA I_{IN}	0 mA to 40 mA I_{IN}
hex	dec	mA	mA
7FF9	32761	>+21.5	> +43.0
7FF8	32760	+19.9951 to +21.5	+39.9902 to +43.0
4000	16384	+10.0	+20.0
0008	8	+4.8828 μ A	+9.7656 μ A
0000	0	< 0	< 0

Input Data Word (Two's Complement)		± 20 mA I_{IN}	± 40 mA I_{IN}
hex	dec	mA	mA
7FF9	32761	>+21.5	> +43.0
7FF8	32760	+19.9951 to +21.5	+39.9902 to +43.0
4000	16384	+10.0	+20.0
0008	8	+4.8828 μ A	+9.7656 μ A
0000	0	0	0
FFF8	-8	-4.8828 μ A	-9.7656 μ A
C000	-16384	-10.0	-20.0
8000	-32768	-20.0 to -21.5	-40.0 to -43.0
8001	-32767	<-21.5	<-43.0

Input Data Word (Two's Complement)		4 mA to 20 mA I_{IN}
hex	dec	mA
7FFD	32765	>+21.5
7FFC	32764	+19.9961 to +21.5
4000	16384	+10
000C	12	+4.003906
0004	4	+3.2 to +4.0
0006	6	< 3.2

"IB RT" Format

The measured value is represented in bits 14 to 0. An additional bit (bit 15) is available as a sign bit.

This format corresponds to the data format used on INTERBUS RT modules.

Diagnostic codes and error bits are not defined in this data format. An open circuit is indicated by the positive final value $7FFF_{hex}$.

Measured value representation in "IB RT" format (15 bits):

15	14	13	12	11	10	9	8	7	6	5	4	3	2	1	0
SB	Analog value														

SB Sign bit

**Significant Measured Values
Voltage Ranges**

Input Data Word (Two's Complement)		0 V to 5 V U_{IN}	0 V to 10 V U_{IN}	0 V to 25 V U_{IN}	0 V to 50 V U_{IN}
hex	dec	V	V	V	V
7FFF	32767	$\geq +4.999847$	$\geq +9.999695$	$\geq +24.999237$	$\geq +49.998474$
7FFE	32766	+4.999695	+9.999390	+24.998474	+49.996948
4000	16384	+2.5	+5	+12.5	+25.0
0001	1	+152.6 μ V	+305.2 μ V	+762.9 μ V	+1.5259 mV
0000	0	0	0	0	0

Input Data Word (Two's Complement)		± 5 V U_{IN}	± 10 V U_{IN}	± 25 V U_{IN}
hex	dec	V	V	V
7FFF	32767	$\geq +4.999847$	$\geq +9.999695$	$\geq +24.999237$
7FFE	32766	+4.999695	+9.999390	+24.998474
4000	16384	+2.5	+5.0	+12.5
0001	1	+152.6 μ V	+305.2 μ V	+762.9 μ V
0000	0	0	0	0
FFFF	-1	-152.6 μ V	-305.2 μ V	-762.9 μ V
C000	-16384	-2.5	-5.0	-12.5
8001	-32767	-4.999847	-9.999695	-24.999237
8000	-32768	≤ -5.0	≤ -10.0	≤ -25.0

Current Ranges:

Input Data Word (Two's Complement)		0 mA to 20 mA I_{IN}	0 mA to 40 mA I_{IN}
hex	dec	mA	mA
7FFF	32767	$\geq +19.9993896$	$\geq +39.9987793$
7FFE	32766	+19.9987793	+39.9975586
4000	16384	+10	+20
0001	1	+0.6104 μ A	+1.2207 μ A
0000	0	0	0

Input Data Word (Two's Complement)		± 20 mA I_{IN}	± 40 mA I_{IN}
hex	dec	mA	mA
7FFF	32767	$\geq +19.999385$	$\geq +39.9987739$
7FFE	32766	+19.998779	+39.9975586
4000	16384	+10.0	+20.0
0001	1	+0.6104 μ A	+1.2207 μ A
0000	0	0	0
FFFF	-1	-0.0006105	-0.0012207
C000	-16384	-10.0	-20.0
8001	-32770	-19.999385	-39.9987793
8000	-32768	≤ -20.0	≤ -40.0

Input Data Word (Two's Complement)		4 mA to 20 mA I_{IN}
hex	dec	mA
7FFF	32767	$\geq +19.9995117$
7FFE	32766	+19.9990234
4000	16384	+12
0001	1	+0.4884 μ A
0000	0	+4.0
0000	0	+3.2 to +4.0
7FFF	32767	<+3.2

"Standardized Display" Format

The data is represented in bits 14 to 0. An additional bit (bit 15) is available as a sign bit.

In this format, data on the measuring range is standardized and represented in such a way that it indicates the corresponding value without conversion.

In this format, **one bit** has the following validity for the measuring ranges stated:

Measuring Range	Validity of One Bit
0 V to 5 V; ±5 V	1 mV
0 V to 10 V; ±10 V	1 mV
0 V to 25 V; ±25 V	1 mV
0 V to 50 V	10 mV
0 mA to 20 mA; 4 mA to 20 mA	1 µA
0 mA to 40 mA	10 µA

This format supports extended diagnostics. Values > 8000_{hex} and < 8100_{hex} indicate an error.

The following diagnostic codes are possible:

Code (hex)	Error
8001	Overrange
8002	Open circuit
8004	Measured value invalid/no valid measured value available (e.g., because the channel was not configured)
8010	Configuration invalid
8020	I/O supply voltage faulty
8040	Module faulty
8080	Under range

Measured value representation in "standardized display" format (15 bits):

15	14	13	12	11	10	9	8	7	6	5	4	3	2	1	0
SB	Analog value														

SB Sign bit

Significant Measured Values Voltage Ranges

Input Data Word (Two's Complement)		0 V to 5 V U_{IN}	0 V to 50 V U_{IN}	± 5 V U_{IN}
hex	dec	V	V	V
8001	OR	> +5.419	> +54.187	> +5.419
152B	5419	+5.419	+54.187	+5.419
1388	5000	+5.0	+50.0	+5.0
0001	1	+1.0 mV	+10.0 mV	+1.0 mV
0000	0	0	0	0
0000	-1	< 0	< 0	-1.0 mV
EC78	-5000	–	–	-5.0
EAD5	-5419	–	–	-5.419
8080	UR	–	–	< -5.419

Input Data Word (Two's Complement)		0 V to 10 V U_{IN}	± 10 V U_{IN}
hex	dec	V	V
8001	OR	> +10.837	> +10.837
2A55	10837	+10.837	+10.837
2710	10000	+10.0	+10.0
0001	1	+1.0 mV	+1.0 mV
0000	0	0	0
0000	0	< 0	–
FFFF	-1	–	-1.0 mV
D8F0	-10000	–	-10.0
D5AB	-10837	–	-10.837
8080	UR	–	< -10.837

Input Data Word (Two's Complement)		0 V to 25 V U_{IN}	± 25 V U_{IN}
hex	dec	V	V
8001	OR	> +27.093	> +27.093
69D5	27093	+27.093	+27.093
61A8	25000	+25.0	+25.0
0001	1	+1.0 mV	+1.0 mV
0000	0	0	0
0000	0	< 0	–
FFFF	-1	–	-1.0 mV
9E58	-25000	–	-25.0
962B	-27093	–	-27.093
8080	UR	–	< -27.093

Current Ranges:

Input Data Word (Two's Complement)		0 mA to 20 mA I_{IN}
hex	dec	mA
8001	OR	> +21.6747
54AA	21674	+21.6747
4E20	20000	+20.0
0001	1	+1.0 μ A
0000	0	0
0000	0	< 0

Input Data Word (Two's Complement)		0 mA to 40 mA I_{IN}
hex	dec	mA
8001	OR	> +43.3493
10EE	4334	+43.3493
0FA0	4000	+40.0
0001	1	+10.0 μ A
0000	0	0
0000	0	< 0

Input Data Word (Two's Complement)		\pm 20 mA I_{IN}
hex	dec	mA
8001	OR	\geq +21.6747
54AA	21674	+21.6747
4E20	20000	+20.0
0001	1	+1.0 μ A
0000	0	0
FFFF	-1	-0.001
B1E0	-20000	-20.0
AB56	-21674	-21.6747
8080	UR	< -21.6747

Input Data Word (Two's Complement)		\pm 40 mA I_{IN}
hex	dec	mA
8001	OR	> +43.349
10EE	4334	+43.349
0FA0	4000	+40.0
0001	1	+10.0 μ A
0000	0	0
FFFF	-1	-10.0 μ A
F060	-4000	-40.0
EF12	-4334	-43.349
8080	UR	< -43.349

Input Data Word (Two's Complement)		4 mA to 20 mA I_{IN}
hex	dec	mA
8001	OR	>+21.339
43BB	17339	+21.339
3E80	16000	+20.0
0001	1	+4.001
0000	0	+4.0 to +3.2
8002	Open circuit	< +3.2

Examples of Measured Value Representation in Various Data Formats

Measuring range: 0 mA to 20 mA

Measured value: 10 mA

Input data word:

Format	hex Value	dec Value	Measured Value
IB IL	3A98	15,000	10 mA
IB ST	4000	16,384	10 mA
IB RT	4000	16,384	10 mA
Standardized display	2710	10,000	10 mA

Measuring range: ± 10 V

Measured value: +5 V

Input data word:

Format	hex Value	dec Value	Measured Value
IB IL	3A98	15,000	5 V
IB ST	4000	16,384	5 V
IB RT	4000	16,384	5 V
Standardized display	2710	5,000	5 V

"PIO" Format

The PIO format enables high-resolution representation of measured values in the 4 mA to 20 mA current measuring range. In this format, an imaginary measuring range of 0 mA to 25 mA is divided into 2^{16} quantization steps (65,536 steps). Thus, unipolar measured currents with a resolution of 0.38 μA /LSB can be represented. Although this format is designed for the 4 mA to 20 mA range, signals between 0 mA and 24 mA can be detected so the overrange limits and the open circuit threshold in the higher-level control system are freely definable.

Measured value representation in "PIO" format (16 bits):

15	14	13	12	11	10	9	8	7	6	5	4	3	2	1	0
Analog value															

Example of parameterization using PIO format

Channel: 1
 Filtering: 16-sample average
 Format: PIO
 Measuring range: 4 mA to 20 mA (PIO format is only supported in this measuring range.)

Option 1:

- 1 Configuring channel 1
 - OUT[0] 4000_{hex}
 - OUT[1] 004A_{hex}
- 2 Reading the measured value
 - OUT[0] 0000_{hex}
 - OUT[1] 0000_{hex}

Option 2:

Configuring channel 1 and reading the measured value

OUT[0] 5000_{hex}
 OUT[1] 004A_{hex}

Significant Measured Values

Input Data Word (Two's Complement)		PIO I_{IN}
hex	dec	mA
F5C2	62914	+24.0
CCCD	52429	+20.0
6666	26214	+10.0
0A3D	2621	+1.0
0001	1	+0.3815 μA
0000	0	+0

Process Data Input Words in the Event of an Error

In the event of an error, the command is mirrored in the input word IN[0] and displayed with the set error bit. The input word IN[1] indicates the error cause.

The following diagnostic codes are valid for configuration or hardware errors **in all data formats**:

Command (hex)	Code (hex)	PF	Meaning/Note	Remedy
	8020	X	I/O supply voltage faulty.	<ul style="list-style-type: none"> – Check the supply voltage of the station head (e.g., U_{BK}). – Check the potential jumper connection.
After module start	8040	X	Module faulty.	Replace module.
0x00	8004		There is no valid configuration for the channel scanned.	Configure channel.
5x00	8004		The configuration just specified is invalid.	Check and correct configuration.
1x00	8010		There is no valid configuration for the channel scanned.	Configure channel.
4x00 and 6000			The parameters are mirrored. This is usually caused by invalid parameters.	Check and correct parameters.
3C00			No diagnostic code.	

PF A peripheral fault is reported to the higher-level control system

In addition to the indicator in the input words, for diagnostic codes 8040_{hex} (module faulty) and 8020_{hex} (I/O supply voltage faulty), a peripheral fault is reported to the higher-level control system.



The **"IB IL"** and **"standardized display"** formats offer additional diagnostic functions. These are specified on page 17 and page 24.

Startup Options

The following startup options illustrate how to use the IB IL AI 8/SF terminal.

Standard Method 1

Task:

- **All input channels** are to be operated **in the same** configuration (6000_{hex})
- Filtering by mean-value generation: 32-sample average (11_{bin}, 3_{dec})
- Format: IB IL (000_{bin}, 0_{dec})
- Measuring range: ±10 V (0001_{bin}, 1_{dec})

Procedure:

- 1 Install the terminal.
- 2 Connect the voltage (power up).
- 3 Configure the terminal (initialization phase; e.g., in the initialization phase of the application program).
- 4 Read the measured value for each channel in turn.

Initialization phase:

According to the task, the appearance of the process data output words is as follows:

		OUT[0]															
Bit		15	14	13	12	11	10	9	8	7	6	5	4	3	2	1	0
Assignment	0	Command							0	0	0	0	0	0	0	0	0
bin	0	1	1	0	0	0	0	0	0	0	0	0	0	0	0	0	0
hex		6				0				0				0			

		OUT[1]																
Bit		15	14	13	12	11	10	9	8	7	6	5	4	3	2	1	0	
Assignment	0	0	0	0	0	0	0	Filter	0	Format			Measuring range					
bin	0	0	0	0	0	0	0	1	1	0	0	0	0	0	0	0	0	1
hex		0				3				0				1				

With the command in OUT[0], the configuration according to OUT[1] is sent to the electronics module. After configuration is complete, the command and the configuration are mirrored in the process data input words.

Configure terminal:	OUT[0]:	6000 _{hex}	OUT[1]:	0301 _{hex}
Configuration completed successfully:	IN[0]	6000 _{hex}	IN[1]:	0301 _{hex}
Error during configuration:	IN[0]	F000 _{hex}	IN[1]:	0301 _{hex}

A cyclic program sequence, which reads the measured values of the individual channels, takes place after configuration has been successfully completed.

The appearance of the process data output word OUT[0] is as follows:

		OUT[0]															
Bit		15	14	13	12	11	10	9	8	7	6	5	4	3	2	1	0
Assignment	0	Command								0	0	0	0	0	0	0	0
bin	0	0	0	0	0	0	Z ₂	Z ₁	Z ₀	0	0	0	0	0	0	0	0
hex		0				x				0				0			

The 0x00_{hex} command does not require any parameters and the value of the parameter word OUT[1] is 0000_{hex}.

With the command in OUT[0], the read request is sent to the electronics module. After the command has been executed, it is mirrored in the process data input word IN[0] and the analog value (xxxx_{hex}) or a diagnostic message (yyyy_{hex}) is displayed in the process data input word IN[1].

Read measured value for channel 1:	OUT[0]:	0000 _{hex}	OUT[1]:	0000 _{hex}
Command executed successfully:	IN[0]	0000 _{hex}	IN[1]:	xxxx _{hex}
Error during execution:	IN[0]	8000 _{hex}	IN[1]:	yyyy _{hex}

Read measured value for channel 2:	OUT[0]:	0100 _{hex}	OUT[1]:	0000 _{hex}
Command executed successfully:	IN[0]	0100 _{hex}	IN[1]:	xxxx _{hex}
Error during execution:	IN[0]	8100 _{hex}	IN[1]:	yyyy _{hex}

and so on until:

Read measured value for channel 8:	OUT[0]:	0700 _{hex}	OUT[1]:	0000 _{hex}
Command executed successfully:	IN[0]	0700 _{hex}	IN[1]:	xxxx _{hex}
Error during execution:	IN[0]	8700 _{hex}	IN[1]:	yyyy _{hex}

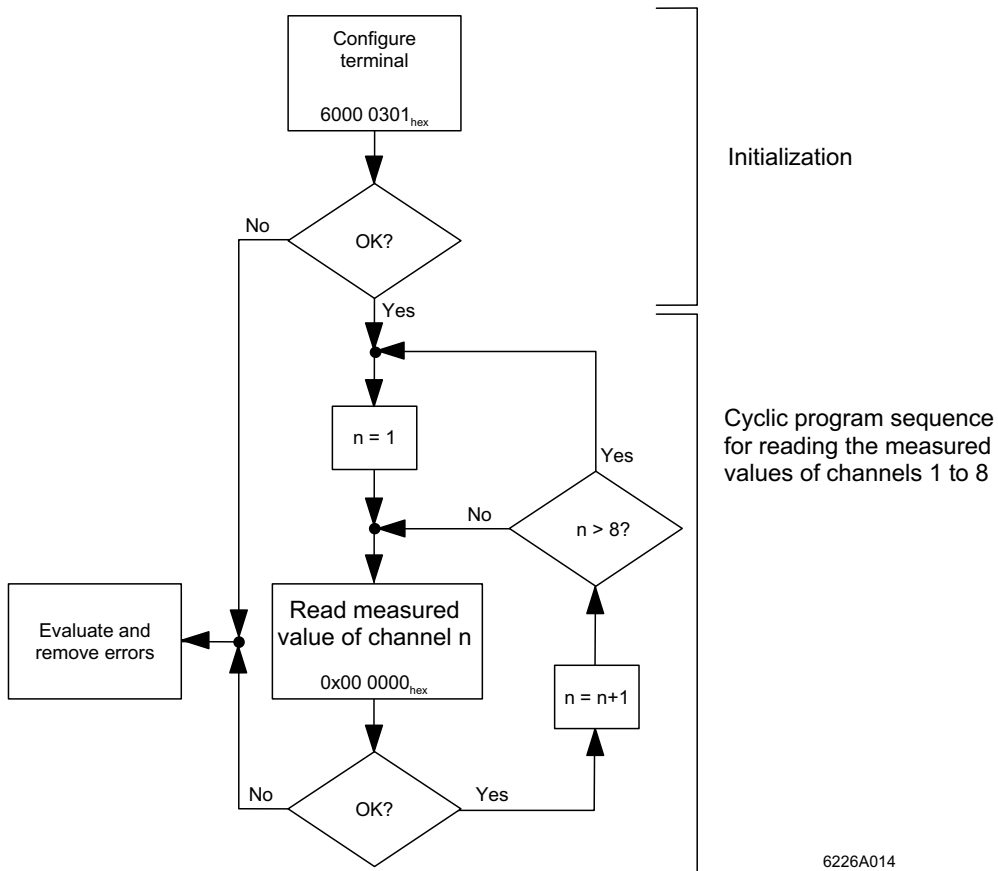

Figure 10 Schematic initialization and cyclic program sequence when configuring the entire terminal

Standard Method 2

Task:

- The input channels are to be operated in **different** configurations. The channels are to be configured first ($4 \times 00_{\text{hex}}$). After configuration, the measured values are to be read ($0 \times 00_{\text{hex}}$).
- Configuration of the channels:

Parameter	Channel 1	Channel 2	Channel 3	...
Filtering by mean-value generation:	No filtering ($01_{\text{bin}}, 1_{\text{dec}}$)	16-sample average ($00_{\text{bin}}, 0_{\text{dec}}$)	4-sample average ($10_{\text{bin}}, 2_{\text{dec}}$)	...
Format:	IB IL ($000_{\text{bin}}, 0_{\text{dec}}$)	IB IL ($000_{\text{bin}}, 0_{\text{dec}}$)	IB IL ($000_{\text{bin}}, 0_{\text{dec}}$)	...
Measuring range:	0 V to 50 V ($0110_{\text{bin}}, 6_{\text{dec}}$)	± 5 V ($0011_{\text{bin}}, 3_{\text{dec}}$)	4 mA to 20 mA ($1010_{\text{bin}}, 10_{\text{dec}}$)	...

Procedure:

- 1 Install the terminal.
- 2 Connect the voltage (power up).
- 3 Configure each individual channel in the terminal in turn (initialization phase; e.g., in the initialization phase of the application program).
- 4 Read the measured value for each channel in turn.

Initialization phase:

The appearance of the process data output word OUT[0] is as follows for **all channels**:

		OUT[0]															
Bit		15	14	13	12	11	10	9	8	7	6	5	4	3	2	1	0
Assignment	0	Command							0	0	0	0	0	0	0	0	0
bin	0	1	0	0	0	0	Z ₂	Z ₁	Z ₀	0	0	0	0	0	0	0	0
hex		4				x				0				0			

The process data output word OUT[1] indicates the parameters for each channel according to the task: For **channel 1**, it looks like this:

		OUT[1]															
Bit		15	14	13	12	11	10	9	8	7	6	5	4	3	2	1	0
Assignment	0	0	0	0	0	0	0	Filter		0	Format			Measuring range			
bin	0	0	0	0	0	0	0	0	1	0	0	0	0	0	1	1	0
hex		0				1				0				6			

With the command in OUT[0], the configuration according to OUT[1] is sent to the electronics module for each channel. After configuration of a channel is complete, the command and the configuration are mirrored in the process data input words.

Configure channel 1:	OUT[0]:	4000 _{hex}	OUT[1]:	0106 _{hex}
Configuration completed successfully:	IN[0]	4000 _{hex}	IN[1]:	0106 _{hex}
Error during configuration:	IN[0]	C000 _{hex}	IN[1]:	0106 _{hex}
Configure channel 2:	OUT[0]:	4100 _{hex}	OUT[1]:	0003 _{hex}
Configuration completed successfully:	IN[0]	4100 _{hex}	IN[1]:	0003 _{hex}
Error during configuration:	IN[0]	C100 _{hex}	IN[1]:	0003 _{hex}
Configure channel 3:	OUT[0]:	4200 _{hex}	OUT[1]:	020A _{hex}
Configuration completed successfully:	IN[0]	4200 _{hex}	IN[1]:	020A _{hex}
Error during configuration:	IN[0]	C200 _{hex}	IN[1]:	020A _{hex}

Configure **channels 4 to 8** according to the example configurations shown.

A **cyclic program sequence, which reads the measured values of the individual channels**, takes place after the configuration for each individual channel has been completed successfully.

The appearance of the process data output word OUT[0] is as follows:

		OUT[0]															
Bit		15	14	13	12	11	10	9	8	7	6	5	4	3	2	1	0
Assignment	0	Command								0	0	0	0	0	0	0	0
bin	0	0	0	0	0	0	Z ₂	Z ₁	Z ₀	0	0	0	0	0	0	0	0
hex		0				X				0				0			

The 0x00_{hex} command does not require any parameters and the value of the parameter word OUT[1] is 0000_{hex}.

With the command in OUT[0], the read request is sent to the electronics module. After the command has been executed, it is mirrored in the process data input word IN[0] and the analog value (xxxx_{hex}) or a diagnostic message (yyyy_{hex}) is displayed in the process data input word IN[1]. The appearance of the process data input and output words is the same as in example 1.

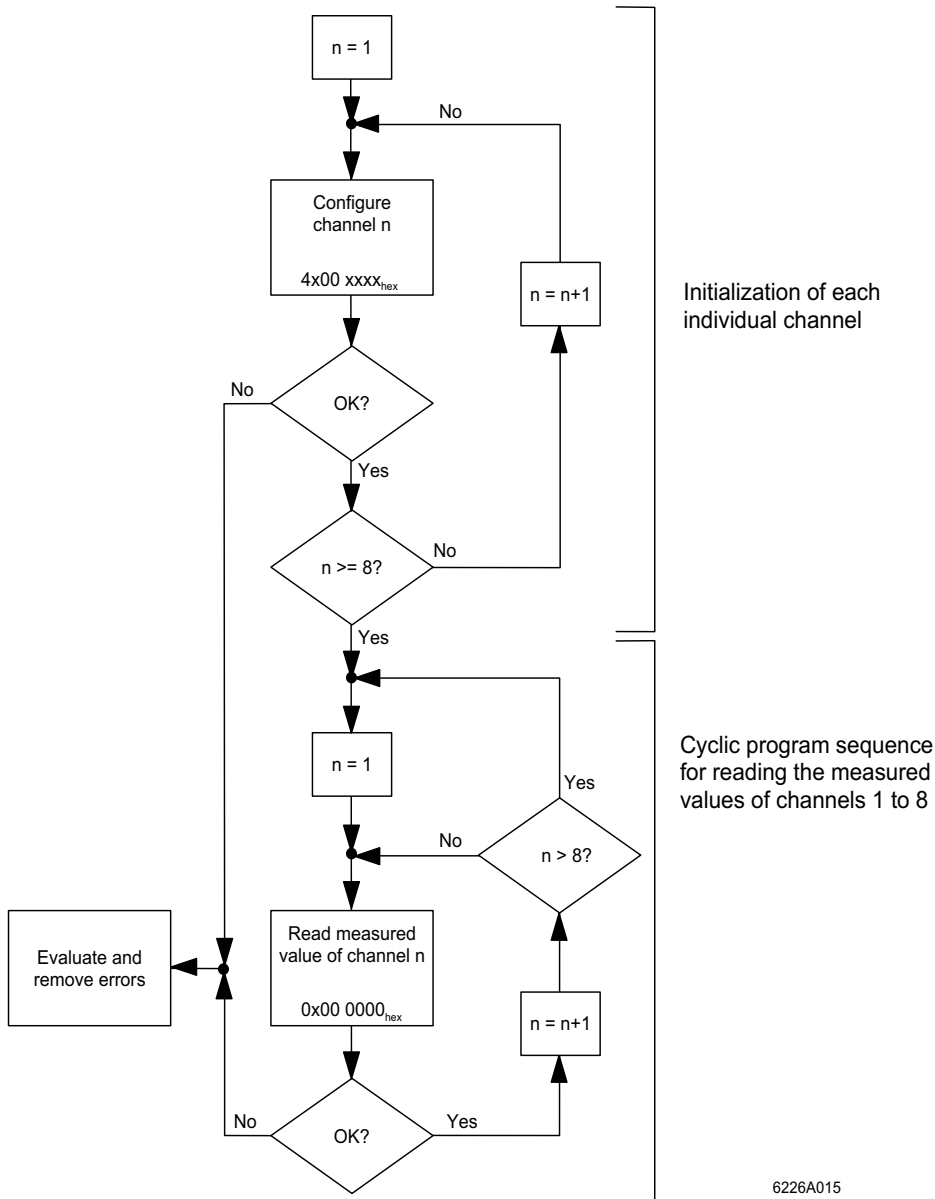

6226A015

Figure 11 Schematic initialization and cyclic program sequence when configuring channels with different parameters

Special Methods

The group commands are regarded as special methods.

Task:

- The measured values of channels 1 to 4 (group A) are to be read in one cycle and the measured values of channels 5 to 8 (group B) in another cycle (7000_{hex} for group A; 7100_{hex} for group B).
- The input channels are to be operated **in different** configurations (e.g., as in example 2).

Procedure:

- 1 Install the terminal.
- 2 Connect the voltage (power up).
- 3 Configure each individual channel in the terminal in turn (initialization phase; e.g., in the initialization phase of the application program).
As the channels are to have different configurations, they must be configured using the 4x00_{hex} command.
- 4 Use group command 7000_{hex} to read the measured values for channels 1 to 4 simultaneously. Then use group command 7100_{hex} to read the measured values for channels 5 to 8. Both groups can be reread cyclically.

Advantages of the Standard Methods Compared With the Special Methods

- The standard methods read the measured values with greater reliability because the command is mirrored for every measured value. Thus, it is possible to detect precisely which channel supplied the measured value.
- The standard methods enable more accurate error diagnostics than the special methods.
- If you switch the group command for reading the channels (e.g., between 7000_{hex} and 7100_{hex} when reading two groups of four channels each), you must allow sufficient time to do so. It must be ensured that the received measured values belong to the requested group. This can only be ensured using waiting times.

Application Notes

Notes on typical applications are provided here in order to facilitate optimal use of the VARIO AI 8/SF terminal in different operating modes.

Precision DC Measurements

Precision DC measurements constitute an optimal area of application for the VARIO AI 8/SF terminal. The high-resolution analog-to-digital converter and excellent instrumentation amplifier technology achieve a very high level of accuracy (typically 0.02% in the voltage range).

In order to take full advantage of these features, the following configurations are recommended:

- Measured value acquisition: according to standard method 1 or 2
- Format: IB IL (high-resolution)
- Filtering: 32-sample average

This suppresses undesirable interference signals and provides a low-noise, accurate measured result. Non-time-critical, i.e., slow, processes are a prerequisite for this configuration.

Closed-Loop Control Tasks

The VARIO AI 8/SF terminal makes closed-loop control tasks particularly easy to carry out. The terminal supports the advantages of INTERBUS with regard to time equidistance. As the terminal scans input signals synchronously with the bus clock and the bus runtime has a very small jitter, the input signals can be scanned equidistantly. Thus, the measured results are particularly suitable for use in closed-loop control.

The following configurations and measures are recommended:

- Measured value acquisition: according to standard method 1 or 2
In special cases, the group commands (7x00_{hex}) can be an exception.
- Filtering: no mean-value generation
As total accuracy is often irrelevant in closed-loop control tasks, filtering is not necessary. This increases the dynamic response of the terminal and speeds up the closed-loop control circuit.
- Adjust the INTERBUS cycle time to the firmware runtime
Example: in standard method 1, the firmware runtime is <800 μs, i.e., the INTERBUS cycle time should be set to 800 μs.

In applications in which an 8-bit resolution is sufficient, group commands 7000_{hex} and 7100_{hex} can be used to read four channels simultaneously. Scanning is synchronous with the bus clock here too. Four channels require <1500 μs.

Signal Scanning or Fast, Sudden Signals

The VARIO AI 8/SF terminal is ideal for scanning signals. As a result of the high input cut-off frequency (3.5 kHz), there are no limiting elements in the analog stage. The maximum signal frequency that can be scanned depends on the firmware runtime and the INTERBUS cycle time.

The terminal measuring device can measure signals with a frequency of $1/800 \mu\text{s} = 1.25 \text{ kHz}$. According to Shannon's sampling theorem, therefore, the signal frequency that can be scanned is $1.25 \text{ kHz}/2 = 0.625 \text{ kHz}$.

This signal frequency can only be achieved if sufficiently fast bus operation can be ensured.

The following configurations and measures are recommended:

- Measured value acquisition: according to standard method 1 or 2
- Filtering: no mean-value generation
This increases the dynamic response of the terminal.
- Adjust the INTERBUS cycle time to the firmware runtime
This achieves discrete periods of scanning. Example: in standard method 1, the firmware runtime is $<800 \mu\text{s}$, i.e., the INTERBUS cycle time should be set to $800 \mu\text{s}$.

Linked Voltages

When using linked voltages, ensure that the VARIO AI 8/SF terminal has eight single-ended inputs. A common ground potential should be used with linked voltages. As the terminal has many measuring ranges, for example the 0 V to 50 V range, and the resolution is high enough, applications with several linked voltages can also be used without any problems.

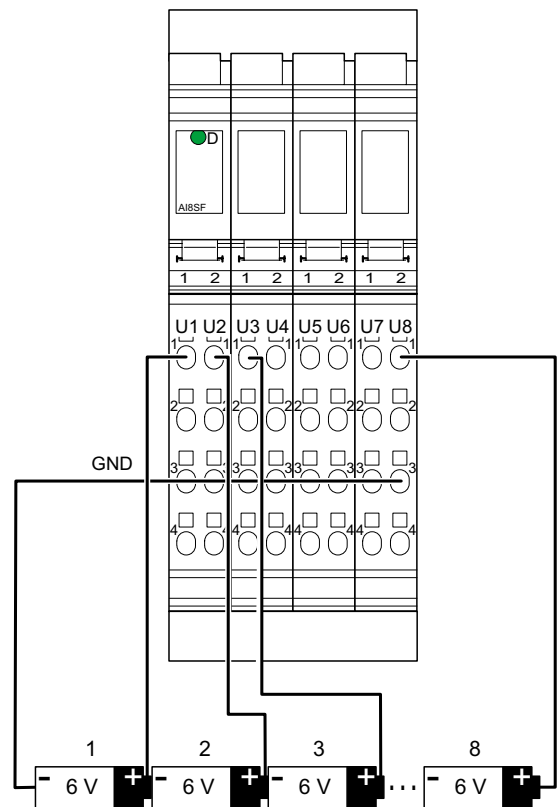

6226A016

Figure 12 Measuring linked voltages

Current Loops

If the IB IL AI 8/SF terminal is used to measure currents in current loops, please ensure that the eight current inputs operate on a common ground potential (single-ended). Thus, the measured input should always be on the GND potential with the minus input.

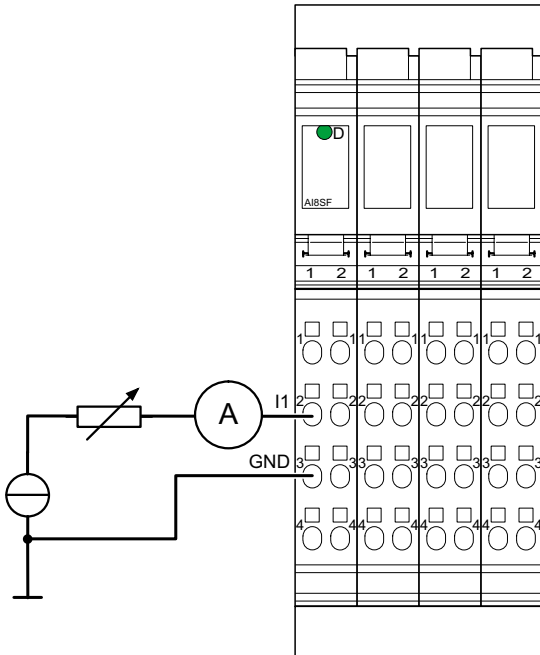

6226A017

Figure 13 Measuring currents

Tolerance and Temperature Response

Voltage inputs

$T_A = 25^\circ\text{C}$ (77°F).

Measuring Range	Absolute (Typical)	Absolute (Maximum)	Relative (Typical)	Relative (Maximum)
0 V to 5 V; ± 5 V	± 1.0 mV	± 5.0 mV	$\pm 0.02\%$	$\pm 0.10\%$
0 V to 10 V; ± 10 V	± 2.0 mV	± 10.0 mV	$\pm 0.02\%$	$\pm 0.10\%$
0 V to 25 V; ± 25 V	± 5.0 mV	± 25.0 mV	$\pm 0.02\%$	$\pm 0.10\%$
0 V to 50 V	± 10.0 mV	± 50.0 mV	$\pm 0.02\%$	$\pm 0.10\%$

$T_A = -25^\circ\text{C} \dots +55^\circ\text{C}$ (-13°F ... +131°F)

Measuring Range	Absolute (Typical)	Absolute (Maximum)	Relative (Typical)	Relative (Maximum)
0 V to 5 V; ± 5 V	± 5.0 mV	± 15.0 mV	$\pm 0.10\%$	$\pm 0.30\%$
0 V to 10 V; ± 10 V	± 10.0 mV	± 30.0 mV	$\pm 0.10\%$	$\pm 0.30\%$
0 V to 25 V; ± 25 V	± 25.0 mV	± 75.0 mV	$\pm 0.10\%$	$\pm 0.30\%$
0 V to 50 V	± 50.0 mV	± 150.0 mV	$\pm 0.10\%$	$\pm 0.30\%$

Current Inputs

$T_A = 25^\circ\text{C}$ (77°F)

Measuring Range	Absolute (Typical)	Absolute (Maximum)	Relative (Typical)	Relative (Maximum)
0 mA to 20 mA; 4 mA to 20 mA; ± 20 mA	± 8.0 μA	± 40.0 μA	$\pm 0.04\%$	$\pm 0.20\%$
0 mA to 40 mA; ± 40 mA	± 16.0 μA	± 80.0 μA	$\pm 0.04\%$	$\pm 0.20\%$



$T_A = -25^\circ\text{C} \dots +55^\circ\text{C}$ (-13°F ... +131°F)

Measuring Range	Absolute (Typical)	Absolute (Maximum)	Relative (Typical)	Relative (Maximum)
0 mA to 20 mA 4 mA to 20 mA ± 20 mA	± 28.0 μA	± 80.0 μA	$\pm 0.14\%$	$\pm 0.40\%$
0 mA to 40 mA ± 40 mA	± 56.0 μA	± 160 μA	$\pm 0.14\%$	$\pm 0.40\%$

Additional Tolerances for Electromagnetic Interference

Type of Electromagnetic Interference	Typical Deviation From the Measuring Range Final Value (Voltage Input)	Typical Deviation From the Measuring Range Final Value (Current Input)
	Relative	Relative
Electromagnetic fields; field strength 10 V/m according to EN 61000-4-3/IEC 61000-4-3	< ±2%	< ±2%
Conducted interference Class 3 (test voltage 10 V) according to EN 61000-4-6/IEC 61000-4-6	< ±1%	< ±1%
Fast transients (bursts) 4 kV supply, 2 kV input according to EN 61000-4-4/IEC 61000-4-4	< ±1%	< ±1%

Technical Data

General Data	
Housing dimensions (width x height x depth)	48.8 mm x 120 mm x 71.5 mm (1.921 in. x 4.724 in. x 2.815 in.)
Weight	125 g (without connectors)
Operating mode	Process data operation with 2 words
Type of sensor connection	2-wire technology
Permissible temperature (operation)	-25°C to +55°C (-13°F to 131°F)
Permissible temperature (storage/transport)	-25°C to +85°C (-13°F to 185°F)
Permissible humidity (operation)	75% on average, 85% occasionally
 Between -25°C and +55°C (-13°F to +131°F) appropriate measures against increased humidity (> 85%) must be taken.	
Permissible humidity (storage/transport)	75% on average, 85% occasionally
 For a short period, slight condensation may appear on the outside of the housing if, for example, the terminal is brought into a closed room from a vehicle.	
Permissible air pressure (operation)	80 kPa to 106 kPa (up to 2000 m [6562 ft.] above sea level)
Permissible air pressure (storage/transport)	70 kPa to 106 kPa (up to 3000 m [9843 ft.] above sea level)
Degree of protection	IP 20 according to IEC 60529
Class of protection	Class 3 according to VDE 0106 and IEC 60536

Interface	
local bus interface	Data routing

Power Consumption	
Communications power U_L	7.5 V
Current consumption from U_L	48 mA, typical/55 mA, maximum
I/O supply voltage U_{ANA}	24 V DC
Current consumption to U_{ANA}	30 mA, typical/35 mA, maximum
Total power consumption	1500 mW, typical

Supply of the Electronics Module and I/Os Through Bus Terminal/Power Terminal	
Connection method	Potential routing

Analog Inputs	
Number	8 analog single-ended inputs
Signals/resolution in the process data word (quantization)	See tables in Section „Formats for Representation of Measured Values“ auf Seite 17
Measured value representation	In the formats IB IL (15-bit with sign bit) IB ST (12-bit with sign bit) IB RT (15-bit with sign bit) Standardized display (15-bit with sign bit) PIO (16-bit)
 Please read the notes on page 18 and page 25 on measured value representation in "IB IL" and "standardized display" format.	
Digital filtering (mean-value generation)	None or over 4, 16 or 32 measured values Default setting: over 16 measured values
Conversion time of the A/D converter	10 µs, maximum
Process data update of the channels	Bus-synchronous
Firmware runtime depending on the command	
– 0x00 _{hex}	< 800 µs
– 5x00 _{hex}	< 850 µs
– 7000 _{hex} /7100 _{hex}	<1500 µs
– 7400 _{hex} /7500 _{hex} /7600 _{hex} /7700 _{hex}	< 1300 µs

Analog Input Stages	
Voltage Inputs	
Input resistance	> 240 kΩ
Limit frequency (-3 dB) of the input filter	3.5 kHz
Behavior upon sensor failure	Goes to 0 V
Maximum permissible voltage between analog voltage inputs and an analog reference potential or between two voltage inputs	50 V

Analog Input Stages (Continued)

Current Inputs	
Input resistance	25 Ω (shunt)
Limit frequency (-3 dB) of the input filter	3.5 kHz
Behavior upon sensor failure	Goes to 0 mA/4 mA
Maximum permissible voltage between analog current inputs and an analog reference potential or between two current inputs	± 2.5 V (corresponds with 100 mA via the shunts)
Maximum permissible current in every input	± 100 mA

Safety Measures

Surge voltage and overcurrents	100% overload, maximum
--------------------------------	------------------------

Electrical Isolation/Isolation of Voltage Ranges

To provide electrical isolation of the logic level and the I/O area, it is necessary to supply the bus terminal and the sensors, which are connected to the described analog input terminal, from separate power supplies. Interconnection of the 24 V power supplies is not permitted.

Common Potentials

The 24 V main power supply, 24 V segment voltage, and GND have the same potential. FE is a separate potential area.

Separate Potentials in the System Consisting of Bus Terminal/Power Terminal and an I/O Terminal

- Test Distance	- Test Voltage
5 V supply incoming remote bus/7.5 V supply (bus logic)	500 V AC, 50 Hz, 1 min
5 V supply outgoing remote bus/7.5 V supply (bus logic)	500 V AC, 50 Hz, 1 min
7.5 V supply (bus logic)/24 V supply U_{ANA} /I/O	500 V AC, 50 Hz, 1 min
7.5 V supply (bus logic)/24 V supply U_{ANA} /functional earth ground	500 V AC, 50 Hz, 1 min
I/Os/functional earth ground	500 V AC, 50 Hz, 1 min

Error Messages to the Higher-Level Control or Computer System

Failure of the voltage supply U_{ANA}	Yes
I/O error/user error	Yes, error message via the process data input words (see page 30)

Ordering Data

Description	Order Designation	Order No.
Terminal with eight analog input channels	VARIO AI 8/SF	KSVC-103-00141



CD Automation srl
Via Picasso 34/36 Legnano (MI) 20025
www.cdautomation.com

Technical modifications reserved