

VARIO AO 2/U/BP

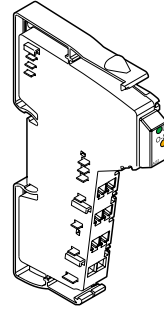

I/O Extension Module With Two Analog Voltage Outputs



User Manual

02/2003

56600001



This data sheet is only valid in association with the documents of the used fieldbus coupler

Function

The terminal is designed for use within an VARIO station. It is used to output analog voltage signals.

Features

- Two analog signal outputs
- Actuator connection (using 2-wire technology and shield connection)
- Voltage ranges:
-10 V to +10 V (13-bit resolution) and
0 V to +10 V (12-bit resolution)
- Output value data available in two formats (IB IL and IB ST)
- Parameterizable behavior of the outputs in the event of an error
- Process data update including conversion time of the digital/analog converter < 1 ms
- Very good output driver properties, therefore also suitable for long actuator cables
- Diagnostic indicators

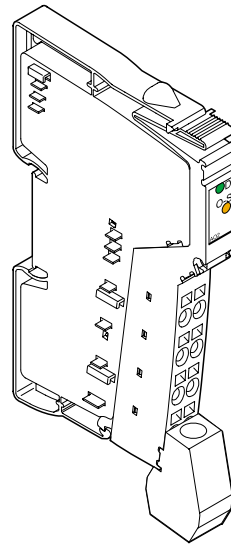

56600007

Figure 1 Terminal VARIO AO 2/U/BP with connectors



All modules will be delivered including connectors and labeling fields

Table of Contents

Function	1
Installation Instructions	4
Internal Circuit Diagram	5
Electrical Isolation	6
Connection	6
Connection Example	7
Connecting Shielded Cables to the Shield Connector	8
Programming Data	10
Process Data Words	11
Output Value Representation Formats	15
Output Behavior	20
Input Behavior	22
Parameterization	24
Technical Data	26
Ordering Data	31

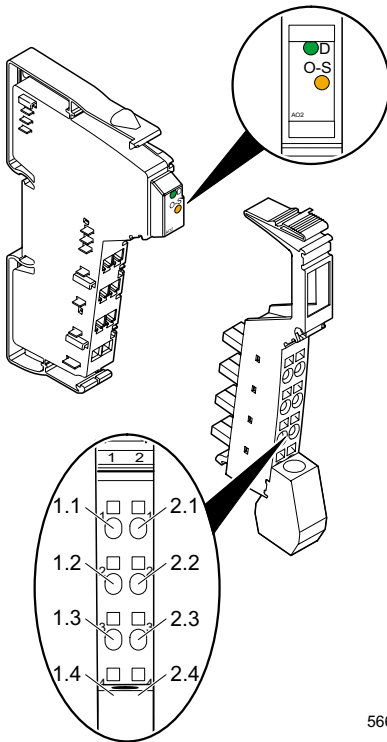

56600002

Figure 2 VARIO AO 2/U/BP with appropriate connector

Local Diagnostic and Status Indicators

Des.	Color	Meaning
D	Green	Bus diagnostics
O-S	Orange	Default state set

Terminal Assignment

Terminal Point	Signal	Assignment
1.1	U1	Voltage output 1
2.1	U2	Voltage output 2
1.2, 2.2	–	Not used
1.3, 2.3	AGND	Voltage output ground
1.4, 2.4	Shield	Shield connection

Parameterized Default Upon Delivery

When the module is delivered, the parameters are set as follows:

- Data format: IB IL
- Behavior of the outputs in the event of an error: Outputs maintain the last value (Hold)
- Output range: -10 V to +10 V

The following terminal parameters can be configured according to conditions, using the process data:

- Data format: IB ST
- Behavior of the outputs in the event of an error: Outputs are reset to 0 V (Reset)
- Output range: 0 V to +10 V



When parameterizing you must switch to parameterization mode. The connection procedure is described in "Parameterization" on page 24.

Installation Instructions

High current flowing through the voltage jumpers U_M and U_S causes the temperature of the voltage jumpers and the internal temperature of the terminal to rise. Note the following instruction to keep the current flowing through the voltage jumpers of the analog terminals as low as possible:



All of the analog terminals need a separate main circuit!

If this is not possible in your application and if you are using analog terminals in a main circuit together with other terminals, make sure you are placing the analog terminals behind all the other terminals at the end of the main circuit.

Please note the derating curve on page 28.

Internal Circuit Diagram

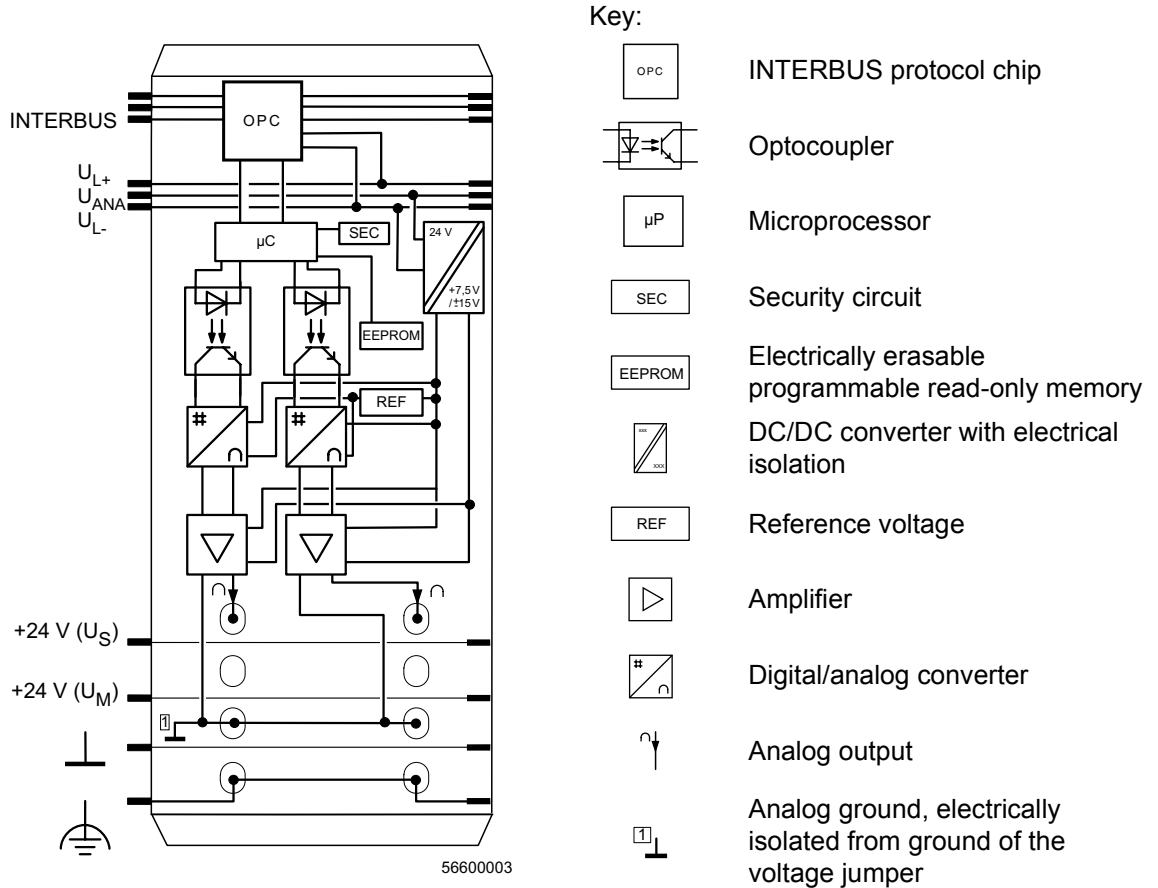

Figure 3 Internal wiring of the terminal points

Electrical Isolation

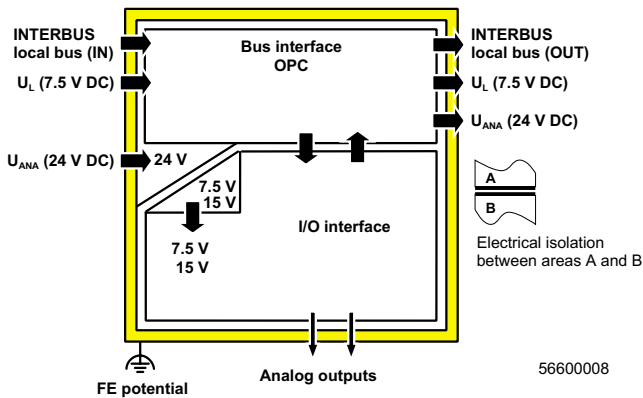

Figure 4 Electrical isolation of the individual function areas

Connection



Analog actuators with a cable length of **< 10 m (32.808 ft.)** can be connected with unshielded twisted-pair cables.



Connect analog actuators with a cable length of **> 10 m (32.808 ft.)** with shielded twisted-pair cables.

Connect one end of the shielding to PE protective earth ground. Fold the outer cable sheath back and connect the shield to the terminal via the shield connector clamp (with strain relief). The clamp connects the shield directly to FE (functional earth ground) on the terminal side.



Ensure that the braided shield is 15 mm (0.591 in.) longer than the strain relief, when connecting a shielded actuator cable to the I/O connector. Connect the actuator cable as described in "Connecting Shielded Cables to the Shield Connector" on page 8.

Connection Example



Use a connector with shield connection when installing the actuators. Figure 5 shows the connection schematically (without shield connector).

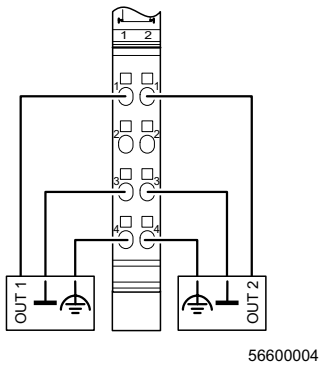
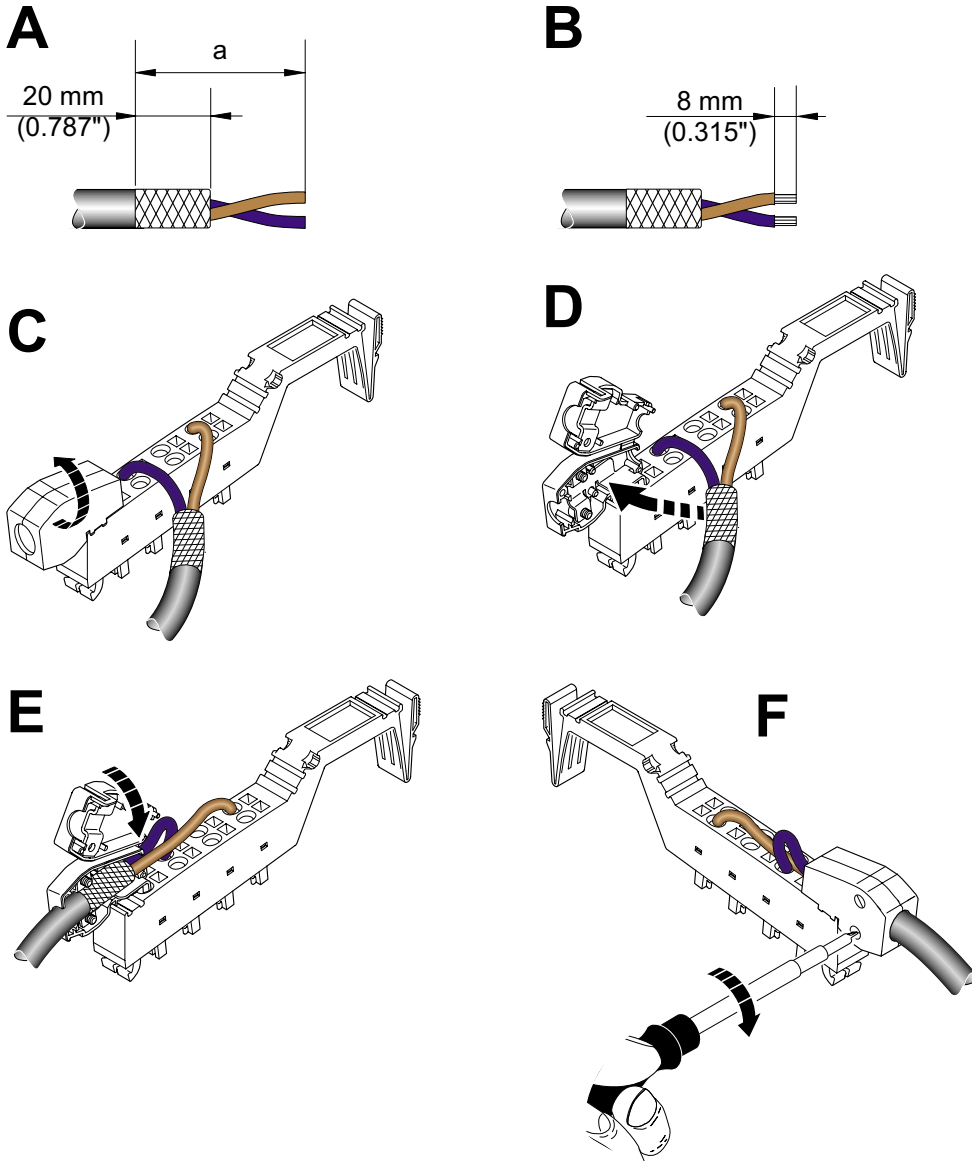

Figure 5 Connection of two voltage actuators with shield connection, using 2-wire technology

Connecting Shielded Cables to the Shield Connector



5660A015

Figure 6 Connecting the shield via the shield connector



The diameter of the actuator cable is usually too large to allow the cable to be installed into the strain relief of the shield connector with sheathed and folded shield. The connection procedure for this cable therefore differs from the connection procedure described in the I/O Systems Manual. The comparative differences with the I/O Systems Manual are marked in bold text.

Connection of the cables according to Figure 6 should be carried out as follows:

Stripping the Cables

- Strip the outer cable sheath to the desired length (a). (1)
The desired length (a) depends on the connection position of the wires and whether the wires should have a large or small amount of space between the connection point and the shield connection.
- Shorten the braided shield to **20 mm (0.787 in.)**. (A)
- Do **not** fold the braided shield back over the outer sheath. (B)
- Remove the protective foil.
- Strip approx. 8 mm (0.315 in.) off the wires. (B)



wiring is normally without ferrules. However, it is possible to use ferrules. If using ferrules, make sure they are properly crimped.

Wiring the Connectors (According to the User Manual)

- Push a screwdriver into the slot above the appropriate terminal point, so that you can insert the wire into the terminal opening. Phoenix Contact recommends using the SZF 1-0.6 x 3.5 mm (0.039-0.024 in. x 0.138 in.) screwdriver (Order No. 12 04 51 7; see Phoenix Contact Catalog Part 3/4 "Marking/Mounting/Tools").
- Insert the wire. Pull the screwdriver out of the opening. The wire is now clamped.

The connector pin assignment can be found in the table on page 3.

Connecting the Shield

- Open the shield connector (see user manual). (C)
- Place the shield clamp in the shield connector corresponding to the cable width (see User Manual).
- Place the cable in the shield connection. (D)
Push the outer cable sheath up to the shield clamp. The wires with the braided shield must be underneath the shield clamp. The braided shield must project approximately 15 mm (0.591 in.) over the shield clamp.
- Close the shield connector. (E)
- Fasten the screws for the shield connector using a screwdriver. (F)

Programming Data

ID code	5B _{hex} (91 _{dec})
Length code	02 _{hex}
Process data channel	32 bits
Input address area	4 bytes
Output address area	4 bytes
Parameter channel (PCP)	0 byte
Register length (bus)	4 bytes

Process Data Words

Assignment of the Terminal Points to the Process Data Output Words

(Word.bit) view	Byte	Word 0														
	Bit	15	14	13	12	11	10	9	8	7	6	5	4	3	2	1
(Byte.bit) view	Byte	Byte 0							Byte 1							
	Bit	7	6	5	4	3	2	1	0	7	6	5	4	3	2	1
Assignment	IB IL format	SB	Channel 1 output value													
Assignment	IB ST format	SB	Channel 1 output value											0	0	0
Terminal points	Signal	Terminal point 1.1: Voltage output 1														
	Signal reference	Terminal point 1.3														
	Shield (FE)	Terminal point 1.4														

(Word.bit) view	Byte	Word 1														
	Bit	15	14	13	12	11	10	9	8	7	6	5	4	3	2	1
(Byte.bit) view	Byte	Byte 2							Byte 3							
	Bit	7	6	5	4	3	2	1	0	7	6	5	4	3	2	1
Assignment	IB IL format	SB	Channel 2 output value													
Assignment	IB ST format	SB	Channel 2 output value											0	0	0
Terminal points	Signal	Terminal point 2.1: Voltage output 2														
	Signal reference	Terminal point 2.3														
	Shield (FE)	Terminal point 2.4														

SB Sign bit

0 In "IB ST" bits 2 through 0 are irrelevant. Set these bits to "0".

Assignment of the Process Data Input Words

(Word.bit) view	Byte	Word 0														
	Bit	15	14	13	12	11	10	9	8	7	6	5	4	3	2	1
(Byte.bit) view	Byte	Byte 0							Byte 1							
	Bit	7	6	5	4	3	2	1	0	7	6	5	4	3	2	1
Assignment		SB	Mirrored channel 1 output value											F	B	H

(Word.bit) view	Byte	Word 1														
	Bit	15	14	13	12	11	10	9	8	7	6	5	4	3	2	1
(Byte.bit) view	Byte	Byte 2							Byte 3							
	Bit	7	6	5	4	3	2	1	0	7	6	5	4	3	2	1
Assignment		SB	Mirrored channel 2 output value											F	B	H

- SB Sign bit
- F Output data format
- B Voltage range
- H Hold/Reset

Process Data Output Words

The process data output words specify the output values in each cycle.

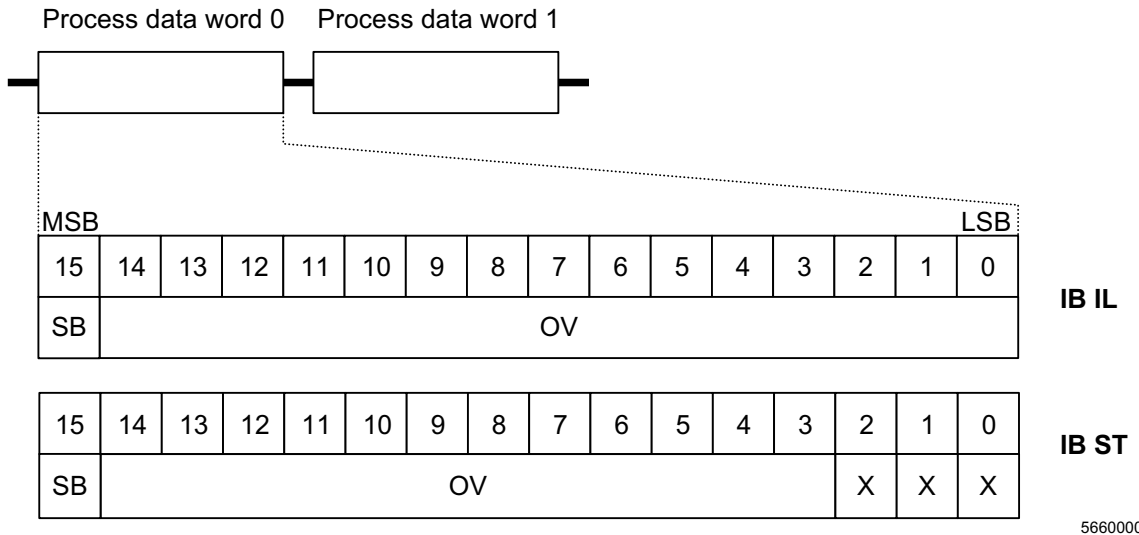

Figure 7 Process data output words in IB IL and IB ST formats

- SB Sign bit
- OV Output value
- X Bit irrelevant
- MSB Most significant bit
- LSB Least significant bit



Set the irrelevant bits to 0.

Process Data Input Words

Bits 15 through 3 of the process data output values are mirrored in the process data input words. Bit 15 is the sign bit. Bits 2 through 0 are available as status bits. They contain information about the parameterized behavior of the terminal.

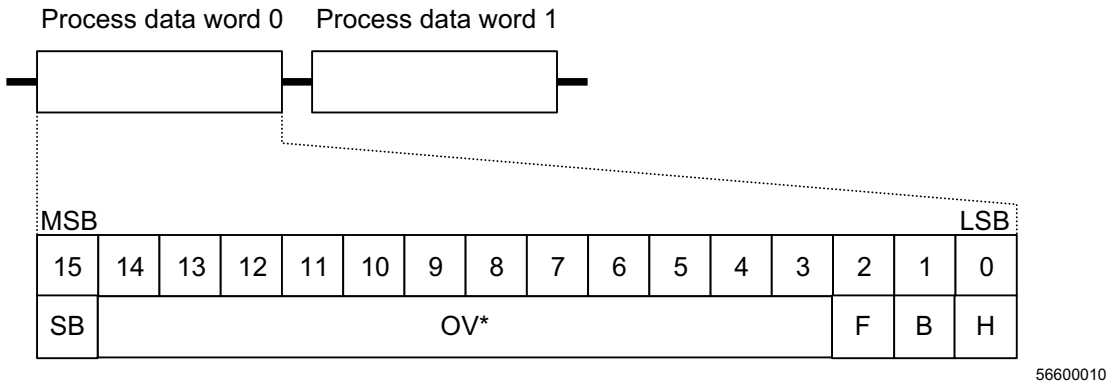

56600010

Figure 8 Process data input words

- SB Sign bit
- OV* Mirrored output value
- F Output data format
- B Voltage range
- H Hold/Reset
- MSB Most significant bit
- LSB Least significant bit

Bits 2 through 0 have the following meaning:

Bit	Designation	Meaning	Bit x = 0	Bit x = 1
2	F	Output data format	IL	ST
1	B	Voltage range	-10 V to +10 V	0 V to +10 V
0	H	Hold/Reset	Hold	0

Output Value Representation Formats



The VARIO AO 2/U/BP terminal has format compatibility with the IB IL AI 2/SF input terminal. This means that it is possible to use these terminals in multiplexer systems (e.g., IB IL MUX).

"IB IL" is the default format. To ensure that the terminals can be operated in previously used ST data formats, the output value representation can be switched to "IB ST" format.

"IB IL" Format

The output value is represented in bits 14 through 0. An additional bit (bit 15) is available as a sign bit.

15	14	13	12	11	10	9	8	7	6	5	4	3	2	1	0
SB	OV														

5660A016

Figure 9 Output value representation in "IB IL" format (15 bits + sign bit)

SB Sign bit
OV Output value

Significant Output Values in "IB IL" Format

The IB IL 24 AO 2 /U/BP terminal has two analog output channels that can supply voltages from -10 V to +10 V with 13-bit resolution.

Output range -10 V to +10 V

Output Data Word (Two's Complement)		-10 V to +10 V U_{output}	Remark
hex	dec	V	
<7FFF	32767	+10.837	
>7F00	32512	+10.837	
7F00	32512	+10.837	
7530	30000	+10.0	
0008	8	+2.667 mV	Smallest DAC quantization step
0001	1	+333.33 μ V	Process data resolution
0000	0	0	
FFF8	-8	-2.667 mV	
8AD0	-30000	-10.0	
8100	-32512	-10.837	
<8100	<i>Processed differently:</i>		
8001	-32767	+10.837	(Over range)
8080	-32640	-10.837	(Under range)
80xx	(Other)	Maintain last value	

For the 0 V to 10 V output range only the upper range is used (see Figure 7). The resolution for this range is thus limited to 12 bits.



Bits 2 through 0 are not always considered as "irrelevant bits". For use as a Field Multiplexer, error messages as well as over or under range information must be evaluated appropriately. Over range (8001_{hex}) outputs 10.837 V, under range (8080_{hex}) 0 V. With an error code (1000 0000 0xxx xxx0_{bin}) the last valid value from the digital/analog converter is output.

Output range 0 V to 10 V

Output Data Word (Two's Complement)		0 V to 10 V U_{Output}	Comment
hex	dec	V	
≤ 7FFF	32512	+10.837	
> 7500	32512	+10.837	
7F00	32512	+10.837	
7530	30000	+10.0	
0008	8	+2.667 mV	Smallest DAC quantization step
0001	1	+333.33 μV	Process data resolution
< 0000	0	0	
< 8100	<i>Processed separately:</i>		
8001	-32767	+10.837	(Over range)
8080	-32640	0	(Under range)
80xx	(Other)	Maintain last value	



The 80xx_{hex} range is reserved exclusively for error and message codes.

IB ST Format

The output value is represented in bits 14 through 3. Bit 15 is available as sign bit. Bits 2 through 0 are irrelevant.

This format corresponds to the data format used on INTERBUS ST modules.

15	14	13	12	11	10	9	8	7	6	5	4	3	2	1	0
SB	OV												X	X	X

56600011

Figure 10 Output value representation in IB ST format (12 bits + sign bit)

- SB Sign bit
- OV Output value
- X Irrelevant bit (Set this bit to 0.)



Bits 2 through 0 are not always considered as "irrelevant bits". The values $7FF9_{hex}$ or 8001_{hex} are recognized as over or under ranges and interpreted as $7FF8_{hex}$ or 8008_{hex} and further processed as normal process data. In this way MUX-compatibility is ensured. The only exceptions are error codes (with ST only an open circuit). With this error code ($xxxx\ xxxx\ xxxx\ xx1x_{bin}$) the last value is maintained.

Significant Output Values in "IB ST" Format

Output range 0 V to 10 V

Output Data Word (Two's Complement)	0 V to 10 V U_{output}
hex	V
> 7FF8	9.9975
7FF8	9.9975
4000	5.0
0008	0.002441
< 0000	0

Output range -10 V to +10 V

Output Data Word (Two's Complement)	-10 V to +10 V U_{output}
hex	V
> 7FF8	9.9975
7FF8	9.9975
0008	0.002441
0000	0
FFF8	-0.002441
8008	-9.9975
< 8008	-9.9975

Output Behavior

Output Behavior During Error-Free Operation (Normal Operation)

On power up during normal operation, the output range and the data format are read using the terminal EEPROM (non-volatile).

Volatile parameterization is also possible for these settings as well as for the behavior of the terminal in the event of an error. This parameterization can be carried out for runtime by a process data sequence.

Output Behavior in the Event of an Error

In the event of an error the outputs behave as set in the EEPROM (non-volatile) or as subsequently parameterized (volatile). This means that the outputs maintain the last value (HOLD, default setting) or are reset to 0 (RESET, parameterizable).

Output Behavior of the Voltage Output



Take output behavior (in the event of an error) into account when configuring your system!

Switching Operation/ State of the Supply Voltage	Marginal Condition	Process Data Output Word (hexadecimal)	Behavior/Status of the Analog Outputs
U_{ANA} from 24 V to 0 V	$U_L = 0$ V	xxxx	0 V
U_{ANA} from 24 V to 0 V	$U_L = 7.5$ V	xxxx	0 V
Bus in Stop	$U_{ANA} = 0$ V	xxxx	0 V
Bus in Stop	$U_{ANA} = 24$ V	xxxx	Maintain last value
Bus reset (e.g., remote bus cable break)		xxxx	Maintain last value (default setting) or 0 V (parameterizable)

U_{ANA} Analog supply voltage of the terminal

U_L Supply voltage of the module electronics (communications power)

xxxx Any value in the range from 0000_{hex} to FFFF_{hex}.

Response of the Control System or Computer to a Hardware Signal for Different Control or Computer Systems

Signal	Control or Computer System	Status After the Switching Operation	
		Process Data Output Word (hexadecimal)	Analog Output
			U_{out}
NORM*	AEG Schneider Automation	0000	0 V
BASP	Siemens S5	0000	0 V
CLAB	Bosch	0000	0 V
SYSFAIL	VME	0000	0 V
SYSFAIL	PC	0000	0 V
CLEAR OUT	Moeller IPC	0000	0 V

* On controller boards for AEG Schneider Automation control systems it is possible to set the NORM signal so that the process data output word and the analog an INTERBUS Controller Board

Command	Status After the Switching Operation	
	Process Data Output Word (hexadecimal)	Analog Output
		U_{out}
STOP	xxxx	Maintain last value
ALARM STOP (reset)	xxxx	Maintain last value (default setting) or 0 V (parameterizable)

Input Behavior

When analyzing input behavior, a distinction is made between normal operation and parameterization mode. Input behavior in parameterization mode is described in "Parameterization" on page 24.

During **error-free normal operation**, the output data is mirrored in the input words as "acknowledgment" in bits 15 through 3 as soon it is transmitted to the DAC.

Bits 2 through 0 are available as status bits and are used to display and read the set behavior of the terminal.

As the VARIO AO 2/U/BP terminal evaluates bits 15 through 3 as data bits both in IB IL and IB ST format, only these 13 bits are mirrored in the input data word (see notes on error codes, over and under ranges).

15	14	13	12	11	10	9	8	7	6	5	4	3	2	1	0
SB	OV*											F	B	H	



56600014

Figure 11 Input data in IB IL and IB ST formats

SB	Sign bit		
OV*	Mirrored output value		
F	Data format	0: IB IL	1: IB ST
B	Output range	0: -10 V to +10 V	1: 0 V to 10 V
H	Hold/Reset	0: Hold	1: Reset

If an **error** is detected by the terminal, it is indicated by an error code in the first process input data word. Possible error codes can be found in the following table.

Error Codes:

Output Data Word (Two's Complement)	Cause	Remedy
hex		
8010	 This code can only appear in parameterization mode and can have two causes:	
	1 Carry out configuration  In step 2 of parameterization, this code appears after sending the code 8055 _{hex} in the first input word. No errors indicated at this point!	Continue configuration
	2 Configuration invalid	Check parameterization
8020	DAC voltage falls below the permissible value	Check the bus terminal voltage supply; Check that the voltage jumpers are connecting safely; Replace the terminal
	 I/O error occurs.	
8040	Terminal defective	Replace the terminal

 The error codes overwrite the status bits (Bits 2 through 0) with "0". This means that in IB ST data format, it is also possible to clearly distinguish valid process data.

Parameterization

When the module is delivered, the terminal parameters are set as follows:

Data format: IB IL
 Behavior of the outputs in the event of an error: Outputs maintain the last value (Hold)
 Output range: -10 V to +10 V

You can configure the following terminal parameters according to your conditions, using the process data:



Data format: IB ST
 Behavior of the outputs in the event of an error: Outputs are reset to 0V (Reset)
 Output range: 0 V to +10 V

In order to parameterize the terminal you must change to parameterization mode. In the first process data output word, transmit codes 8033_{hex} and 8055_{hex} one after the other.



In order not to change accidentally to parameterization mode, you should set bits 2 through 0 to 0 in normal operation when transmitting process data.

Parameterizing the Terminal:

<p>Step 1:</p>	<p>Transmission of code 8033_{hex} in the first process data output word.</p> <p>In bits 15 through 3 of the first process data input word this code is acknowledged as a normal process data item.</p> <p> For every subsequent code which is not equal to 8055_{hex} in the first process data word, normal operation continues and the code is interpreted as a process data item.</p>
<p>Step 2:</p>	<p>Transmission of code 8055_{hex} in the first process data output word.</p> <p>Acknowledgment is via code 8010_{hex} in the first input word.</p> <p>In this case, this code does not indicate an error, but shows that a configuration word is eventually expected (in step 3).</p> <p> For every subsequent code that is not equal to 80xx_{hex} in the first process data word, parameterization mode is quit.</p>



Step 3:	<p>Transmission of the parameterization code: 1000 0000 1000 $p_3p_2p_1$_{bin}.</p> <p>Where p_x are the terminal parameters:</p> <p>p_3: Data format (0: IB IL; 1: IB ST)</p> <p>p_2: Output range (0: -10 V to 0 V; 1: 0 V through 10 V)</p> <p>p_1: Reset behavior (0: Hold; 1: Reset)</p> <p>Acceptance of the value is confirmed in bits 15 through 3 of the first input word through mirroring of the code. If an invalid configuration is displayed, code 8010_{hex} appears in the first input data word, which indicates the error "Invalid Configuration".</p> <p>This step can be repeated as often as you like.</p> <p> If a code that is not equal to 80xx_{hex} is transmitted in the first process data word, parameterization mode is quit without the parameterization taking effect.</p>
Step 4:	<p>In this step you specify, whether the parameterization stored in the EEPROM is volatile (dynamic) or non-volatile (static).</p> <p>Volatile parameterization: After a power up this setting is no longer available. Subsequent operation uses the settings stored in the EEPROM.</p> <p>Transmission of code 8077_{hex}.</p> <p>Non-volatile parameterization: The parameterization is stored in the EEPROM. After a power up this parameterization from the EEPROM is used.</p> <p>Transmission of code 8099_{hex}.</p> <p>After writing 8077_{hex} or 8099_{hex} the parameterization takes effect and parameterization mode is quit. This is displayed in the first input word through the mirroring of code 8077_{hex} or 8099_{hex}. These values have a dedicated acknowledgment function. Only the next process data item is processed as normal.</p>



If parameterization was aborted, it is possible to switch to parameterization mode using a restart with step 1.

The orange O-S LED on the terminal indicates whether the original configuration is present or if the current configuration differs from the default configuration of the terminal upon delivery. The LED is lit if the parameterization is that of the default upon delivery.

Technical Data

General Data	
Housing dimensions (width x height x depth)	12.2 mm x 120 mm x 71.5 mm (0.480 in. x 4.724 in. x 2.815 in.)
Weight	48 g (without connector)
Operating mode	Process data operation with 2 words
Actuator connection type	2-wire technology
Permissible temperature (operation)	-25°C to +55°C (-13°F to 131°F)
Permissible temperature (storage/transport)	-25°C to +85°C (-13°F to 185°F)
Permissible humidity (operation)	75% average, 85% occasionally
 In the range from -25°C to +55°C (-13°F to +131°F) appropriate measures against increased humidity (> 85%) must be taken.	
Permissible humidity (storage/transport)	75% average, 85% occasionally
 For a short period, slight condensation may appear on the housing if, for example, the terminal is brought into a closed room from a vehicle.	
Permissible air pressure (operation)	80 kPa to 106 kPa (up to 2000 m [6561.680 ft.] above sea level)
Permissible air pressure (storage/transport)	70 kPa to 106 kPa (up to 3000 m [9842.520 ft.] above sea level)
Degree of protection	IP 20 according to IEC 60529
Class of protection	Class 3 according to VDE 0106, IEC 60536
Interface	
local bus interface	Data routing

Power Consumption	
Communications voltage U_L	7.5 V
Current consumption from U_L	Approximately 33 mA, typical; 40 mA, maximum
I/O supply voltage U_{ANA}	24 V DC
Current consumption from U_{ANA}	
No-load operation ($R_L > 10 \text{ M}\Omega$)	18 mA, typical; 28 mA, maximum
Full load operation ($R_L = 2 \text{ k}\Omega$)	25 mA, typical; 35 mA, maximum
Total power consumption	
No-load operation ($R_L > 10 \text{ M}\Omega$)	0.68 W, typical
Full load operation ($R_L = 2 \text{ k}\Omega$)	0.85 W, typical

Supply of the Module Electronics and I/O Through Bus Terminal/Power Terminal	
Connection method	Voltage routing

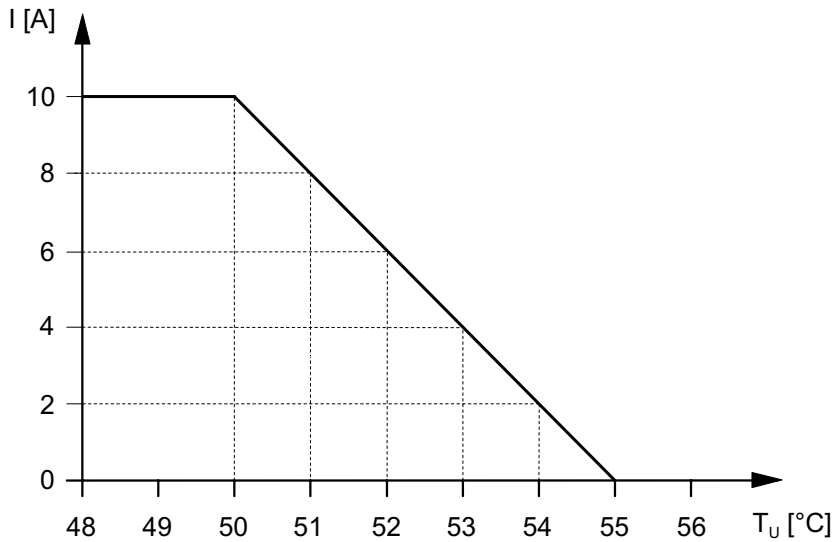
Derating: Permissible Ambient Temperature Depending on the Current of the Voltage Jumpers U_M and U_S (Total Current)

56600012

Upwards of $T_U = +50^\circ\text{C}$ (122°F) the derating is 2 A/K.

 T_U

Ambient temperature (°C)

 I

Current flowing through voltage jumpers U_M and U_S (A)

Analog Outputs	
Number	2
Signal connection type	2-wire technology, single-ended
Signals/resolution in the process data word (quantization)	
Voltage	-10 V to +10 V
	333.33 μ V/LSB
Voltage	0 V to +10 V
	333.33 μ V/LSB
Representation of output value	
	-10 V to +10 V
	16 bit two's complement
	0 V to +10 V
	16 bit two's complement
 For the representation of the output value in the different formats please refer to the notes in "Output Value Representation Formats" on page 15.	
Smallest DAC quantization step	
	-10 V to +10 V
	2.667 to 13 mV
	0 V to +10 V
	2.667 to 12 mV
Basic error limit	$\pm 0.02\%$, typical, of the output range final value
Output load	2 k Ω , minimum
Process data update time including the conversion time of the digital/analog converter	1 local bus cycle (dependent on the bus configuration); < 1 ms
Signal rise time (slew rate)	
	10% to 90% of the final value
	15 μ s, typical
	0% to > 99% of the final value
	31 μ s, typical
Signal rise time (slew rate) -9.0 V to +9.0 V	
	No-load operation
	0.35 V/ μ s, typical
	With ohmic load ($R_L = 2$ k Ω)
	0.24 V/ μ s, typical
	With ohmic/capacitive load
	$R_L = 2$ k Ω / $C_L = 10$ nF
	0.24 V/ μ s, typical
	With ohmic/capacitive load
	$R_L = 2$ k Ω / $C_L = 220$ nF
	0.09 V/ μ s, typical
Transient protection of the analog outputs	Yes

Tolerance and Temperature Response (Absolute Tolerance Values) (The tolerance values refer to the output range final value of 10 V.)		
	Typical	Maximum
Tolerance at 23°C (73.4°F)		
Total offset voltage	±0.5 mV	±4.0 mV
Gain error	±2.5 mV	±6.0 mV
Differential non-linearity	±1.3 mV	±3.9 mV
Total tolerance at 23°C (73.4°F)	±4.3 mV	±13.9 mV
Temperature response at -25°C to +55°C (-13°F to 131°F)		
Offset voltage drift T_{KVO}	±2.1 mV	±5.0 mV
Gain drift T_{KG}	±9.2 mV	±20.0 mV
Total voltage drift $T_{Ktot} = T_{KVO} + T_{KG}$	±11.3 mV	±25.0 mV
Total tolerance of the voltage output (-25°C to 55°C [-13°F to 131°F]) Offset error + gain error + linearity error + drift error	±15.6 mV	±38.9 mV

Tolerance and Temperature Response (Relative Tolerance Values) (The tolerance values refer to the output range final value of 10 V.)		
	Typical	Maximum
Tolerance at 23°C (73.4°F)		
Total offset voltage	±0.005%	±0.027%
Gain error	±0.025%	±0.060%
Differential non-linearity	±0.013%	±0.027%
Total tolerance at 23°C (73.4°F)	±0.09%	±0.14%
Temperature response at -25°C to +55°C (-13°F to 131°F)		
Offset voltage drift T_{KVO}	4 ppm/K	10 ppm/K
Gain drift T_{KG}	18 ppm/K	40 ppm/K
Total voltage drift $T_{Ktot} = T_{KVO} + T_{KG}$	23 ppm/K	50 ppm/K
Total tolerance of the voltage output (-25°C to 55°C [-13°F to 131°F]) Offset error + gain error + linearity error + drift error	±0.16%	±0.39%

Additional Tolerances for Electromagnetic Interference		
Type of Electromagnetic Interference	Typical Deviation of the Output Range Final Value (Voltage Output)	
	Relative	Absolute
Electromagnetic fields; field strength 10 V/m acc. to IEC 61000-4-3 / IEC 61000-4-3	< $\pm 0.2\%$	< ± 20 mV
Conducted interference Class 3 (test voltage 10 V) acc. to IEC 61000-4-6 / IEC 61000-4-6	< $\pm 2.8\%$	< ± 280 mV
 The values are valid for shielded and unshielded twisted actuator cables.		

Safety Devices	
Transient protection of the analog outputs	Yes

Electrical Isolation / Isolation of the Voltage Areas	
 The electrical isolation of the logic level from the I/O area is ensured through the DC/DC converter.	
Common Potentials	
24 V I/O voltage, 24 V segment voltage, and GND have the same potential. FE (functional earth ground) is a separate potential area.	
Separate System Potentials Consisting of Bus Terminal/Power Terminal and I/O Terminal	
- Test Distance	- Test Voltage
7.5 V supply (bus logic) / 24 V supply U_{ANA} / I/O	500 V AC, 50 Hz, 1 min
7.5 V supply (bus logic) / 24 V supply U_{ANA} / functional earth ground	500 V AC, 50 Hz, 1 min
24 V supply (I/O) / functional earth ground	500 V AC, 50 Hz, 1 min

Error Messages to the Higher-Level Control or Computer System	
Failure or dropping of communications voltage U_L	Yes, I/O error message to the bus terminal

Ordering Data

Description	Order Designation	Order No.
Terminal with two analog voltage outputs with connector and labeling field	VARIO AO 2/U/BP	KSVC-103-00221



CDAutomation srl
Via Picasso 34/36
20025 Legnano (MI)
Italy



+39 - (0331) 577479



+39 - (0331) 579479



www.cdautomation.com

Subject to technical modification