

VARIO DO 8/24

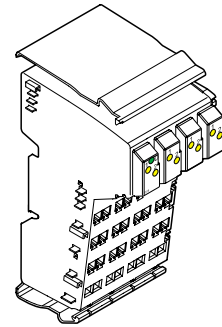

I/O Extension Module With Eight Digital Outputs



User Manual

02/2003

55581001



This data sheet is only valid in association with the documents of the used fieldbus coupler

Function

The terminal is designed for use within an VARIO station. It is used to output digital signals.

Features

- Connections for eight digital actuators
- Connection of actuators in 2-, 3-, and 4-wire technology
- Nominal current per channel: 0.5 A
- Total current of the terminal: 4 A
- Short circuit and overload protected outputs
- Diagnostic and status indicators

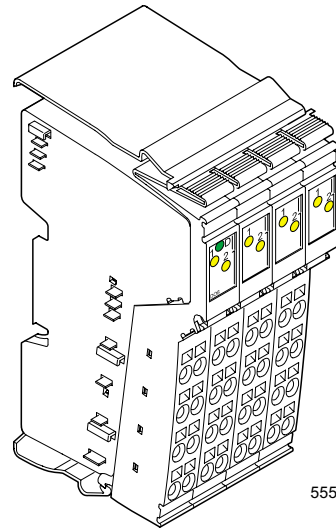

55582002

Figure 1 VARIO DO 8/24 terminal with connectors



All modules will be delivered including connectors and labeling fields

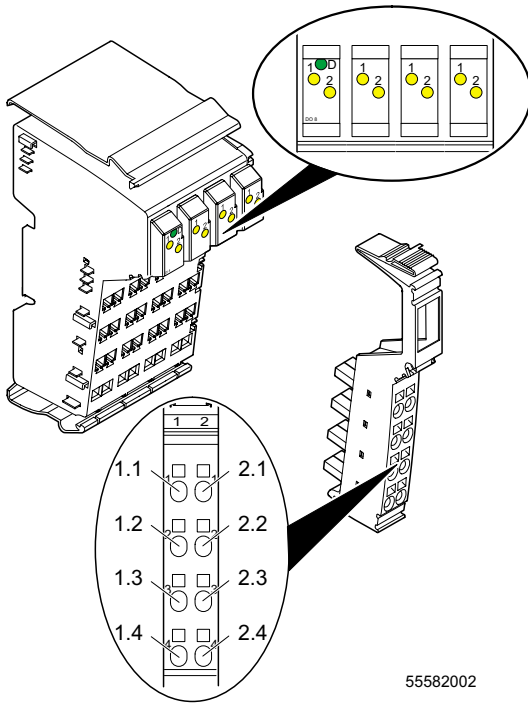

55582002

Figure 2 VARIO DO 8/24 with appropriate connectors

Local Diagnostic and Status Indicators

Des.	Color	Meaning
D	Green	Bus diagnostics
1, 2	Yellow	Status indicators of the outputs

Terminal Assignment for Each Connector

Terminal Point	Assignment
1.1, 2.1	Signal output (OUT)
1.2, 2.2	Segment voltage U_S for 4-wire termination Measuring point for the supply voltage
1.3, 2.3	Ground contact (GND) for 2-, 3-, and 4-wire termination
1.4, 2.4	FE connection for 3- and 4-wire termination

Internal Circuit Diagram

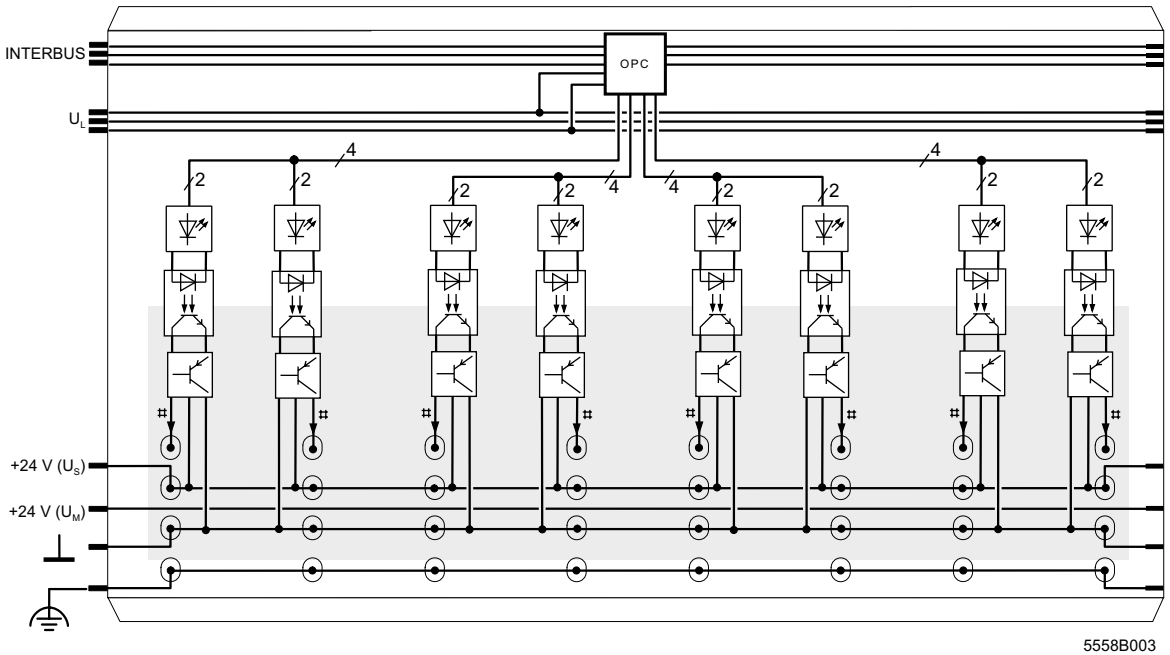







Figure 3 Internal wiring of the terminal points

Key:

- 
INTERBUS protocol chip
(bus logic including voltage conditioning)
 - 
LED
 - 
Optocoupler
 - 
Transistor
 - 
Digital output
- 
Isolated area

Connection Example



When connecting the actuators, observe the assignment of the terminal points to the fieldbus output data (see page 5).

Programming Data

ID code	BD _{hex} (189 _{dec})
Length code	81 _{hex}
Process data channel	8 bits
Input address area	0 bytes
Output address area	1 byte
Parameter channel (PCP)	0 bytes
Register length (bus)	1 byte

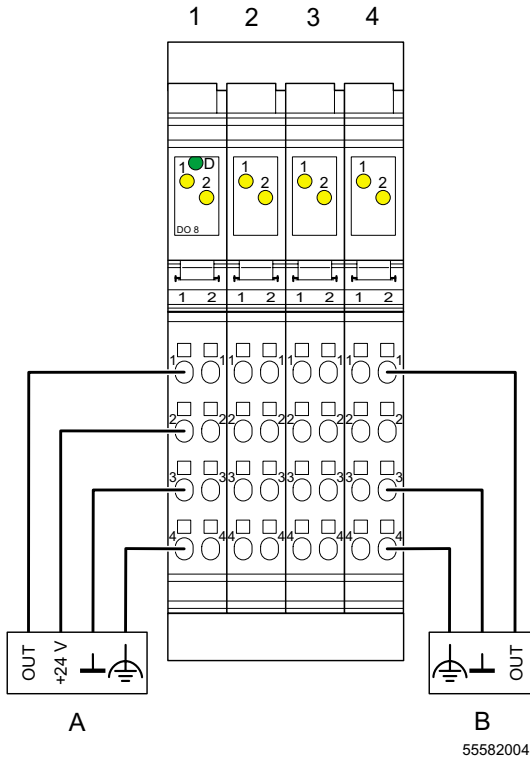

Figure 4 Typical actuator connections

A 4-wire termination

B 3-wire termination

The numbers shown above the terminal indicate the slots for the connectors.

Process Data





IN process data is not available.

Assignment of the Terminal Points to the OUT Process Data

(Byte.bit) view	Byte	Byte 0							
	Bit	7	6	5	4	3	2	1	0
Assignment	Slot	4		3		2		1	
	Terminal point (signal)	2.1	1.1	2.1	1.1	2.1	1.1	2.1	1.1
	Terminal point (+24 V)	2.2	1.2	2.2	1.2	2.2	1.2	2.2	1.2
	Terminal point (GND)	2.3	1.3	2.3	1.3	2.3	1.3	2.3	1.3
	Terminal point (FE)	2.4	1.4	2.4	1.4	2.4	1.4	2.4	1.4
Status indicator	Slot	4		3		2		1	
	LED	2	1	2	1	2	1	2	1



Technical Data

General Data	
Housing dimensions (width x height x depth)	48.8 mm x 120 mm x 71.5 mm (1.921 in. x 4.724 in. x 2.815 in.)
Weight	130 g (without connector)
Operating mode	Process data operation with 8 bits
Connection method of the actuators	2-, 3-, and 4-wire technology
Permissible temperature (operation)	-25°C to +55 °C (-13°F to +131°F)
Permissible temperature (storage/transport)	-25°C to +85°C (-13°F to +185°F)
Permissible humidity (operation)	75%, on average, 85%, occasionally
 In the range from -25°C to +55°C (-13°F to +131°F) appropriate measures against increased humidity (> 85%) must be taken.	
Permissible humidity (storage/transport)	75%, on average, 85%, occasionally
 For a short period, slight condensation may appear on the housing if, for example, the terminal is brought into a closed room from a vehicle.	
Permissible air pressure (operation)	80 kPa to 106 kPa (up to 2000 m [6562 ft.] above sea level)
Permissible air pressure (storage/transport)	70 kPa to 106 kPa (up to 3000 m [9843 ft.] above sea level)
Degree of protection	IP 20 according to IEC 60529
Class of protection	Class 3 according to VDE 0106, IEC 60536

Interface	
local bus interface	Through data routing

Power Consumption	
Communications power	7.5 V
Current consumption from the local bus	60 mA, maximum
Power consumption from the local bus	0.45 W, maximum
Segment supply voltage U_S	24 V DC (nominal value)
Nominal current consumption at U_S	4 A (8 x 0.5 A), maximum

Supply of the Module Electronics and I/O Through Bus Terminal/Power Terminal	
Connection method	Through potential routing

Digital Outputs	
Number	8
Nominal output voltage U_{OUT}	24 V DC
Differential voltage for I_{nom}	≤ 1 V
Nominal current I_{nom} per channel	0.5 A
Tolerance of the nominal current	+10%
Total current	4 A
Protection	Short circuit; overload
 Each of the four channels are thermally coupled, i.e., an error in one channel can affect the other channels.	
Nominal load	
Ohmic	48 Ω /12 W
Lamp	12 W
Inductive	12 VA (1.2 H, 50 Ω)
Signal delay upon power up of	
- Ohmic nominal load	100 μ s, typical
- Lamp nominal load	100 ms, typical (with switching frequencies up to 8 Hz; above this frequency the lamp load responds like an ohmic load)
- Inductive nominal load	100 ms, typical (1.2 H, 50 Ω)
Signal delay upon power down of	
- Ohmic nominal load	1 ms, typical
- Lamp nominal load	1 ms, typical
- Inductive nominal load	50 ms, typical (1.2 H, 50 Ω)
Switching frequency with	
- Ohmic nominal load	300 Hz, maximum
 This switching frequency is limited by the selected data rate, the number of bus devices, the bus structure, the software, and the control or computer system used.	
- Lamp nominal load	300 Hz, maximum
 This switching frequency is limited by the selected data rate, the number of bus devices, the bus structure, the software, and the control or computer system used.	
- Inductive nominal load	0.5 Hz, maximum (1.2 H, 48 Ω)

Digital Outputs (Continued)	
Overload response	Auto restart
Response time with ohmic overload (12 Ω)	3 s, approximately
Restart frequency with ohmic overload	400 Hz, approximately
Restart frequency with lamp overload	400 Hz, approximately
Inductive overload response	Output may be damaged
Response time after short circuit	400 ms, approximately
Reverse voltage endurance against short pulses	Protected against reverse voltages
Strength against permanently applied reverse voltages	Up to 2 A DC
Strength against polarity reversal of the supply voltage	Components on the bus terminal or the power terminal
Strength against permanently applied surge voltage	No
Validity of output data after connection of 24 V voltage supply (power up)	5 ms, typical
Response upon power down	The output follows the supply voltage without delay.
Limitation of the demagnetization voltage induced on circuit interruption	$-15 \text{ V} \leq U_{\text{demag}} \leq -46 \text{ V}$ (U_{demag} = demagnetization voltage)
Single maximum energy in free running	400 mJ, maximum
Protective circuit type	Integrated 45 V Zener diode in output chip
Overcurrent shutdown	At 0.7 A, minimum
Output current when switched off	300 μA, maximum
Output voltage when switched off	2 V, maximum
Output current with ground connection interrupted	25 mA, maximum
Switching power with ground connection interrupted	100 mW at 1 kΩ load resistance, typical
Inrush current with lamp load	1.5 A for 20 ms, maximum

Output Characteristic When Switched On (Typical)	
Output Current (A)	Differential Output Voltage (V)
0	0
0.1	0.04
0.2	0.08
0.3	0.12
0.4	0.16
0.5	0.20

Power Dissipation	
Formula to Calculate the Power Dissipation of the Electronics	
$P_{\text{tot}} = 0.19 \text{ W} + \sum_{n=1}^8 (0.10 \text{ W} + I_{L_n}^2 \times 0.4 \ \Omega)$	
Where	
P_{tot}	Total power dissipation of the module
n	Index of the number of set outputs $n = 1$ to 8
I_{L_n}	Load current of the output n
Power Dissipation of the Housing P_{HOU}	2.7 W, maximum (within the permissible operating temperature)

Concurrent Channel Derating	
Derating	No limitation of the channel simultaneity, no derating

Safety Devices	
Overload/short circuit in segment circuit	Electronic; with two 4-channel drivers

Safety Devices	
Surge voltage	Protective circuits of the power terminal Protection up to 33 V DC
Polarity reversal of voltage supply	Protective circuits of the power terminal It is necessary to protect the voltage supply. The power supply unit should be able to supply 4 times (400%) the nominal current of the external fuse.
Reverse voltage	Protection up to 2 A DC

Electrical Isolation/Isolation of the Voltage Areas	
	To provide electrical isolation between the logic level and the I/O area, it is necessary to supply the station bus terminal and the digital output terminal described here using the bus terminal or a power terminal from separate power supply units. Interconnection of the 24 V power supplies is not allowed.

Common Potentials	
24 V main power, 24 V segment voltage, and GND have the same potential. FE is a separate potential area.	
Separate Potentials in the System Consisting of Bus Terminal/Power Terminal and I/O Terminal	
- Test Distance	- Test Voltage
5 V supply incoming remote bus/7.5 V supply (bus logic)	500 V AC, 50 Hz, 1 min.
5 V supply outgoing remote bus/7.5 V supply (bus logic)	500 V AC, 50 Hz, 1 min.
7.5 V supply (bus logic)/24 V supply (I/O)	500 V AC, 50 Hz, 1 min.
24 V supply (I/O)/functional earth ground	500 V AC, 50 Hz, 1 min.

Error Messages to the Higher-Level Control or Computer System	
Short circuit/overload of an output	Yes
 An error message is generated when an output is shorted and switched on. In addition, the diagnostic LED (D) flashes on the terminal at 2 Hz (medium) under these conditions.	
Operating voltage out of range	No

Ordering Data

Description	Order Designation	Order No.
Terminal with eight digital outputs with connectors and labeling fields	VARIO D0 8/24	KSVC-102-00241



CD Automation srl
Via Picasso 34/36
20025 Legnano (MI)
Italy



+39 - (0331)577479



+39 - (0331)579479



www.cdautomation.com

Subject to technical modification