

**vario BT**  
**Operating terminal for modular controller**  
**system**



**Operating manual**  
**9499-040-75911**  
**valid from 8428**

Kassel, 27.05.04

**Content**

<b>GENERAL NOTES .....</b>	<b>4</b>
<b>SAFETY AND PRECAUTIONARY MEASURES.....</b>	<b>4</b>
<b>COMMISSIONING/SHUT-DOWN .....</b>	<b>5</b>
<b>UNPACKING THE INSTRUMENT .....</b>	<b>5</b>
<b>ELECTRICAL CONNECTIONS.....</b>	<b>5</b>
<b>POWER SUPPLY .....</b>	<b>5</b>
<b>BUS CABLES.....</b>	<b>5</b>
<b>CONNECTIONS AND MOUNTING.....</b>	<b>7</b>
<b>HINTS FOR CONNECTION .....</b>	<b>8</b>
<b>KS VARIO BT COM3 (RS485) CONNECTING CABLE TO KS VARIO MODBUS COUPLER .....</b>	<b>10</b>
<b>CABLE FOR CONNECTION OF KS VARIO BT COM1 (RS232) TO KS VARIO CONTROLLER MODULE ENGINEERING PORT .....</b>	<b>10</b>
<b>OPERATOR INTERFACE.....</b>	<b>11</b>
<b>FUNDAMENTALS .....</b>	<b>11</b>
<b>COMMISSIONING AND BASIC CONFIGURATION OF A NEW OPERATING TERMINAL .....</b>	<b>12</b>
<b>KS VARIO CONFIGURATION.....</b>	<b>12</b>
<b>KS VARIO BT CONFIGURATION .....</b>	<b>13</b>
<b>BASIC PRINCIPLES OF OPERATION.....</b>	<b>14</b>
<b>THE SURVEY PAGE .....</b>	<b>14</b>
<b>THE CONTROLLER PAGE.....</b>	<b>15</b>
<b>THE PAGE FOR CONTROLLER GROUP OPERATION.....</b>	<b>16</b>
<b>THE TREND PAGE .....</b>	<b>17</b>
<b>LIMIT VALUES .....</b>	<b>18</b>
<b>PARAMETER SETTING AND SPECIAL DIALOGUES.....</b>	<b>19</b>
<b>THE PARAMETER PAGE.....</b>	<b>19</b>
<b>SELF-TUNING .....</b>	<b>20</b>
<b>GROUP OPERATION .....</b>	<b>21</b>
<b>COPYING SETTINGS .....</b>	<b>22</b>
<b>RECIPES .....</b>	<b>23</b>
<b>PASSWORDS.....</b>	<b>24</b>
<b>TECHNICAL DATA .....</b>	<b>25</b>

## General notes

KS vario BT was designed to realize a de-central terminal for KS vario multi-channel controller operation and monitoring. It can be used for operation of the bussable KS vario without an additional automation system. The standard version permits operation of up to 30 control loops connected to a terminal.

These operating instructions are valid for KS vario BT versions with order number:

**KSCV-111-01151.**

For versions, see data sheet.

## Safety and precautionary measures

This instrument was built and tested in accordance with VDE 0411 / EN 61010-1 and was shipped in safe condition. Protection class is IP65 (front panel) or IP20 (rear).

The instrument complies with European guideline 89/336/EEC (EMC) and is provided with the CE marking.

To maintain this condition and to ensure safe operation, the user must follow the hints and warnings given in these operating instructions and in the safety hints.

The overall equipment of machines / systems intended for the European market must comply with EN 60 204 part 1/85 (identical with VDE 0113 part 1 / 02.86).

With machines / systems intended for exportation into other than European countries, the applicable national safety regulations must be taken into account.

- a As compliance with the safety regulation is beyond our influence, liability for damage resulting from failure to comply with one or several of these regulations is precluded.

The list of applicable safety regulations cannot be comprehensive (German and foreign machine regulations). Failure to include one of these regulations in the list does not mean that is not applicable.

Repair and maintenance work may be done only by persons who are recognized specialists in the sense of the regulations: VDE standards, law on instrument safety, trade association regulations for accident prevention.

The instrument may be operated only by qualified persons. Operation without impairment of its safety is possible only within the permissible environmental conditions (see data sheet).

The instrument is provided exclusively for application as an operating terminal for measurement and control instrumentation in technical installations.

## Commissioning/shut-down

### Unpacking the instrument

Check, if the consignment is correct and complete. Inspect the instrument for damage due to improper handling during transport and storage.

- a If the instrument is damaged to an extent that safe operation cannot reasonably be expected, the instrument must not be taken into operation.
  
- a Before installation/dismounting of the instrument, or before mounting or dismounting of connectors on the instrument, KS vario BT must be disconnected completely from the supply voltage, i.e. the instrument must be de-energized.

### Electrical connections

The electrical connections must be in compliance with the national standards (e.g. VDE 0100 in Germany).

For improved interference suppression, the signal and data lines must be kept separate from power supply cables. Before fitting or removing connectors on KS vario BT, the supply voltage must be switched off completely.

### Power supply

KS vario BT requires an external supply voltage rating of 24V DC (-15%/+20%), max. power consumption 12W. Connection is via a 3-pole terminal ( e.g. Phoenix type: FRONT-MSTB, 2,5/3-ST-5,08). Note the polarity.

### Bus cables

For the bus cable, we recommend using a screened data cable. One end of the screening must be connected to KS vario BT. The D-connectors / D-sockets of KS vario BT are connected conductantly with the housing.

Connecting diagram for cable screening

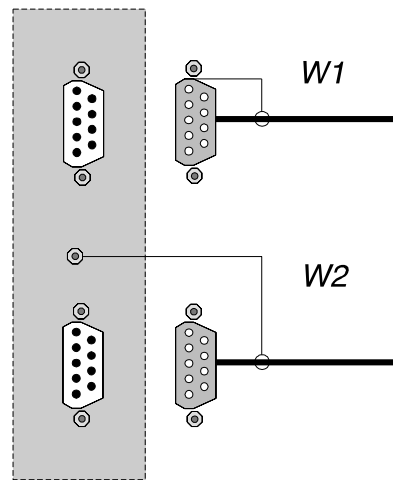

**The connection of KS vario BT to the terminal provided for this purpose should be of low resistance. The cable for connection to PE should be as short as possible!**

## Connections and mounting

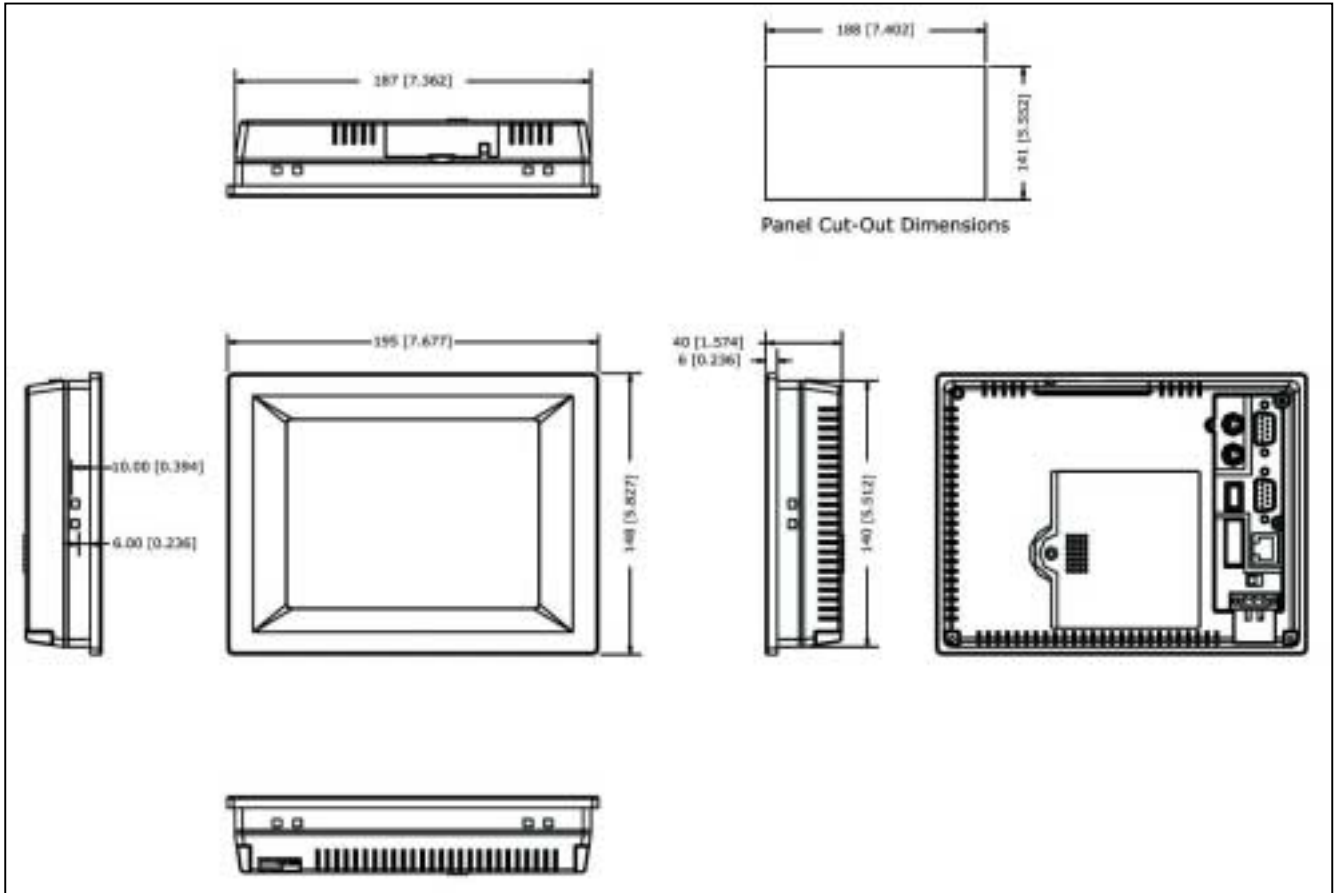

Fig. 1: KS vario BT dimension drawing

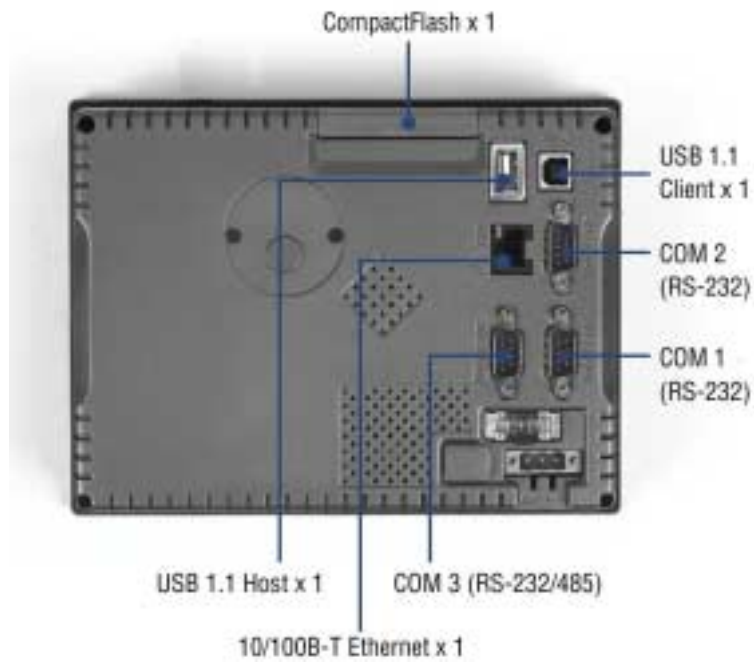

Fig. 2 KS vario BT rear panel

## Hints for connection

### Power supply

KS vario BT requires an external power supply rating of 24V DC (-15%/+20%), max. power consumption 12W. Connection is via a 3-pole terminal (e.g. Phoenix type: FRONT-MSTB, 2,5/3-ST-5,08)

- a** Ensure correct connection to the protective earth system using a protective earth conductor.



Pin 1: + 24VDC  
Pin 2: -24VDC (Gnd)  
PIN 3: PE

### Fuse

The supply voltage is protected by means of a fuse in the terminal. A fine-wire fuse with the following rating is used:

Electrical values: 250V AC, 5A quick-acting  
Dimensions: 5x20mm



- g** For fuse replacement, proceed as follows:

- Remove the fuse cover
- Replace the fuse
- Re-fit the cover

- a** ***Do not replace the fuse before removing the cause for blowing. Only spare fuses with identical rating should be used.***



### **COM1 RS232 interface**

RS232 interface, 9-pole D-SUB connector with the following pin allocation:

<b>Pin no.</b>	<b>Description</b>	<b>Signal</b>
1	DCD	
2	RXD	RS232 receive data
3	TXD	RS232 send data
4	DTR	
5	GND	GND
6	DSR	
7	RTS	
8	CTS	
9	RI	

### **COM3 RS485 bus interface**

RS485 interface, 9-pole D-SUB connector with the following pin allocation:

<b>Pin no.</b>	<b>Description</b>	<b>Signal</b>
1	DATA-	Inverted data signal
2	n.c.	-----
3	n.c.	-----
4	DATA+	Data signal
5	GND	GND
6	n.c.	-----
7	n.c.	-----
8	n.c.	-----
9	n.c.	-----

**a n.c. Connections to unused signals are not permissible!**

## KS vario BT COM3 (RS485) connecting cable to KS vario Modbus coupler

### KSvarioBT

9-pole sub-D socket with metal cover

Pin allocation:

pin 1: Data-A  
 pin 2: n.c.  
 pin 3: n.c.  
 pin 4: Data-B  
 pin 5: n.c.  
 pin 6: n.c.  
 pin 7: n.c.  
 pin 8: n.c.  
 pin 9: n.c.

Screening connected to connector housing

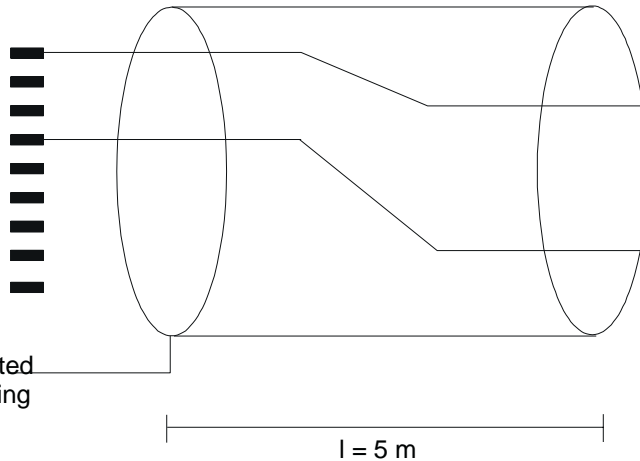

### KSvario

9-pole sub-D connector with metal cover

Pin allocation:

pin 1: n.c.  
 pin 2: n.c.  
 pin 3: Data-A  
 pin 4: n.c.  
 pin 5: n.c.  
 pin 6: n.c.  
 pin 7: n.c.  
 pin 8: Data-B.  
 pin 9: n.c.

Min. 2-pole, screened cable,  
 One end of screening connected

## Cable for connection of KS vario BT COM1 (RS232) to KS vario controller module engineering port

### KSvarioBT

-9-pole Sub-D socket with metal cover

Belegung:

pin 1: n.c.  
 pin 2: TxD  
 pin 3: RxD  
 pin 4: n.c.  
 pin 5: Gnd  
 pin 6: n.c.  
 pin 7: n.c.  
 pin 8: n.c.  
 pin 9: n.c.

Screening connected to connector housing

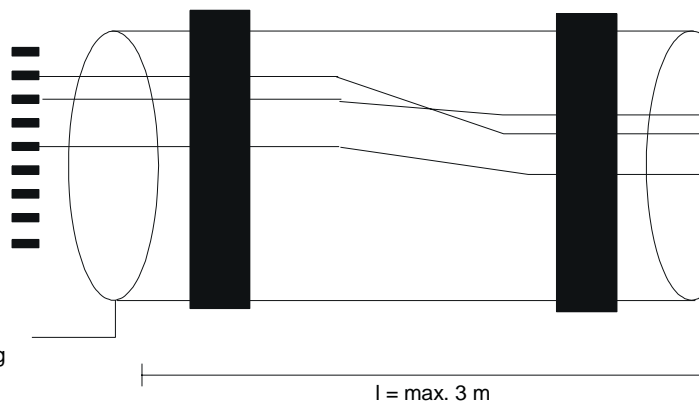

Min. 3-pole, screened cable,  
 One end of screening connected

Ferrite cable cores suitable for cable diameter, fixed at both cable ends

### KSvario

3-pole stereo jack d=3,5 mm, with plastic cover

Pin allocation:  
 pin 1: TxD  
 pin 2: RxD  
 pin 3: Gnd

## Operator interface

### Fundamentals

The operation consists of dialogue pages which offer an overall survey and other pages which offer detail information on individual control channels.

The three modes for changing operator dialogues are:

1. Exit from the main page by [ X ].  
A menu dialogue based on the workstation with a Windows computer is displayed. The icons on the menu page can be used to open new dialogue pages.
2. Keys for direct selection  
Can be used for calling up **adjacent operator dialogues** directly.
3. Parameter page menu  
Access to the parameter setting pages from the main operating page is via a pull-down menu.

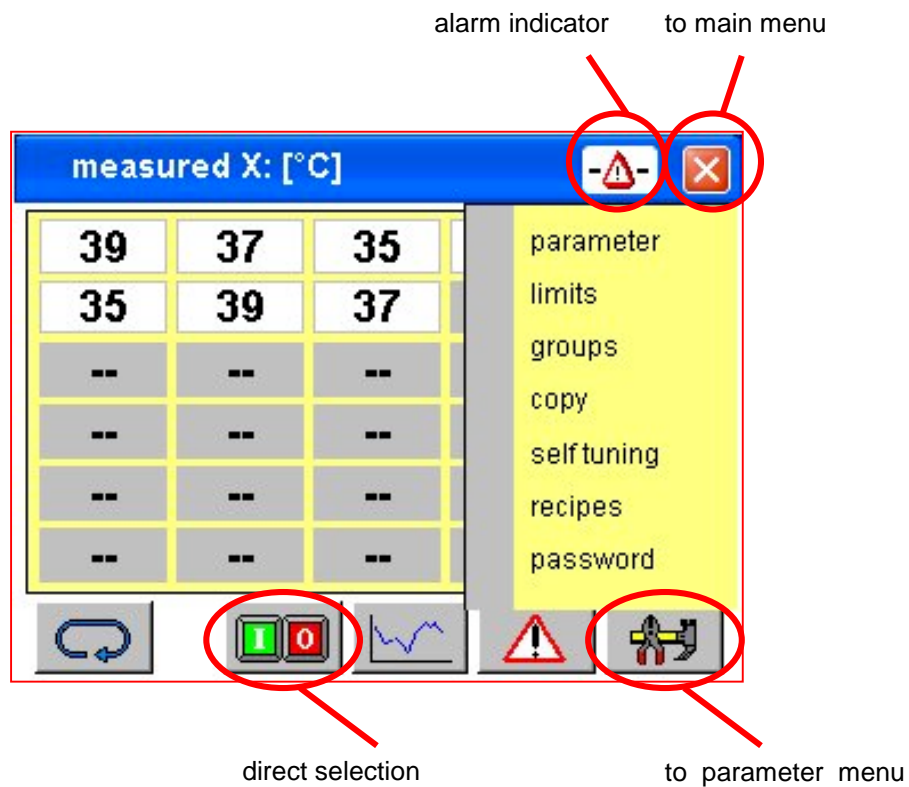

## Commissioning and basic configuration of a new operating terminal

### KS vario configuration

g At first, configure your KS-Vario by means of the BlueControl® engineering tool.

- With a Modbus version, select Baudrate 38400 and address 1.
- Enter 5ms into field "Modem delay".

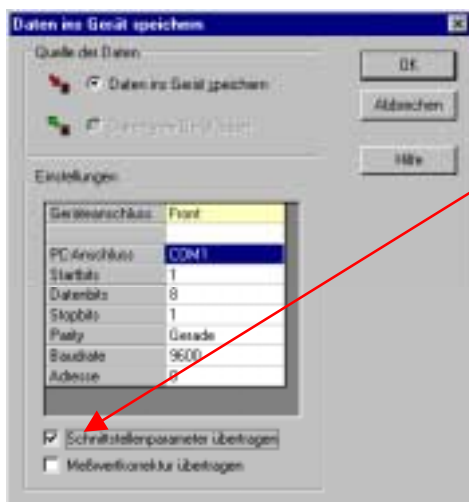
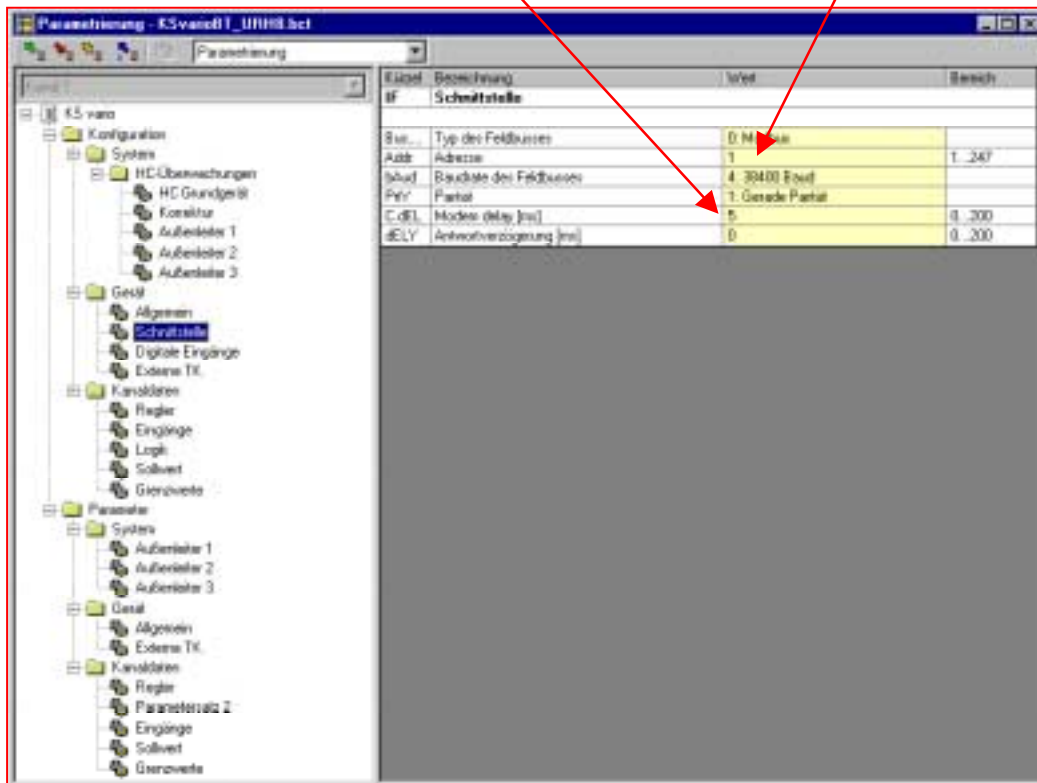

During download from the BlueControl® engineering tool into Ks vario, please, don't forget to transmit also the interface parameters (tick 'Transfer communication parameters').

### KS vario BT configuration

Connect the terminal to controller: KS vario with MODBUS coupler using the appropriate RS 485 cable between COM3 and the connector on the bus coupler.

KS vario with other field bus couplers using the relevant RS 232 cable between COM1 and the KS-Vario controller module diagnostic interface.

After starting the terminal, the main operating dialogue is displayed.

Exit from this dialogue is via [ X ].

Select [ Config ] on the menu page.

Select [ Setup ] on the following menu page.



Please, configure in the following order:

- At first, select the interface. RS485 for Modbus interfaces and RS232 for all other interfaces.
- Now, select the required language using the key for language selection.
- Then, select the number of required zones.
- Press key [ load defaults ].  
The terminal generates an address list and descriptions for the controller channels.

If necessary, channel descriptions and address allocation can be adapted individually.

- Name: channel description with max. 10 characters
- Device: Modbus coupler addresses
- Channel: channel number in the relevant KS-Vario

Press the arrow keys for access to the other controller channels.

### **g** Please, don't forget to store the basic settings !

Touch [ X ] for exit from the set-up dialogue.

Leave the configuration menu via [ Menu ] or [ X ].

Select [ Survey ].

## Basic principles of operation

### The survey page

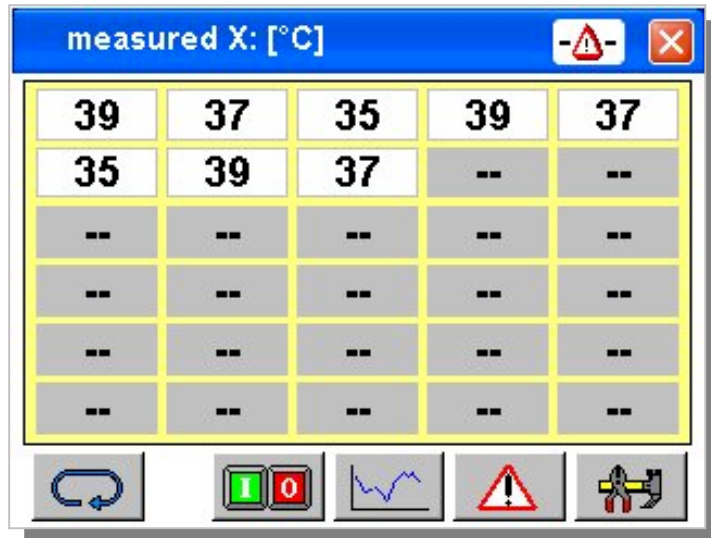

The controller channel process values are displayed on the survey page. Touch [ toggle ] at the bottom left for display switch-over to other measured values. In case of alarms, status display of the relevant channel is by means of the following colours:

<b>Limit alarms</b>	<b>Low slarm</b>	<b>Out-of-tolerance</b>	<b>High alarm</b>
<b>Limit 3</b>	blue blinking	orange blinking	red blinking
<b>Limit 2</b>	blue	orange	red
<b>Limit 1</b>	light blue	light orange	light red

<b>Sensor break</b>	Display "ERR" black / white blinking
---------------------	--------------------------------------

### Direct selection of important dialogues

When touching a displayed measured value, the page with detail information on the relevant channel is opened. Return to the survey by touching icon [ spectacles ], or via the menu.

For channel group switch-on/off, change to the main operating page via [ I/O ]. This page provides buttons for heating on, heating off and for standby. Return from this page to the survey is also by touching icon [ spectacles ], or via the menu.

### The controller page

On the pages for controller operation per channel, the most important information on a controller is displayed and can be changed.

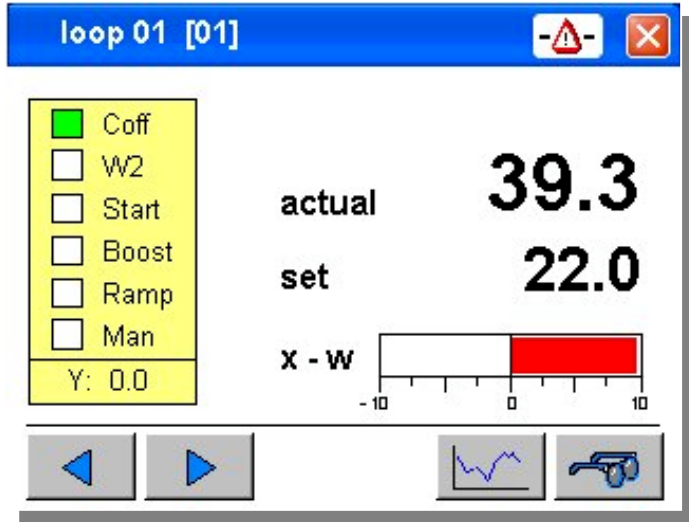

Green status displays:

- Coff The controller is switched off; for switching on, touch the item.
- W2 The controller uses the 2nd setpoint; switch-over is possible by touching.
- Start The start-up circuit is active.
- Boost The boost program is active; de-activation is possible by touching.
- Ramp A setpoint gradient is active.
- Man The controller operates in manual mode; activation is possible by touching.

Touching the setpoint will display a keypad for entry of the setpoint.  
 During manual mode, the manual correcting variable is displayed in this position.  
 Touch the arrow keys for access to the controller channels.  
 The channel is displayed in the header.

**g** If the adjusted value is different from the effective setpoint, e.g. due to an active setpoint ramp, the colour of the displayed setpoint is changed.  
 In this case, the adjusted value is displayed below the setpoint for entry.

**The page for controller group operation**

On this page, the overall system or parts thereof can be switched on and off.

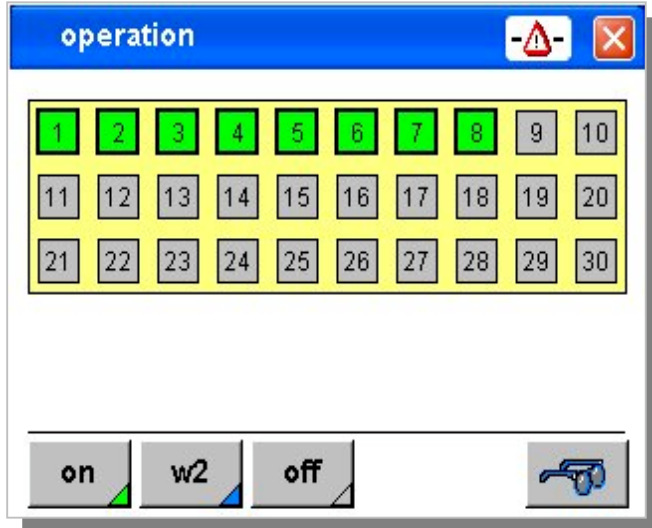

Touching buttons [ on ], [ off ] and [ w2 ] always influences all channels displayed with bold border lines.

Normally (no groups configured), all activated zones are selected initially. Channels which should not be active must be de-selected individually.

During group operation, no zone is selected initially. Individual channels or groups can be selected.

Status display

Green	The relevant controller is active.
Blue	Lowering setpoint w2 of the channel is active.
Gray	The controller is switched off (coff).



**The trend page**

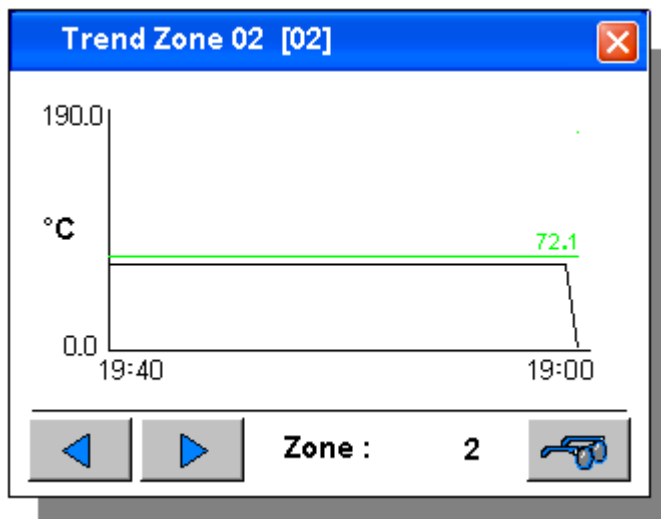

The setpoint and process value curves over the last 40 minutes are displayed on the trend page. Additionally, a horizontal cursor indicates the instantaneously active setpoint. Selection of a different channel is possible by touching the arrow buttons, or by direct input on the bottommost line. Y-axis scaling is done automatically. The **actual** value is displayed on the left !

**Limit values**

loop	lim(1)	lim(2)	lim(3)	(HC)
loop 01 :	85.0	0.0	258.0	0.0
loop 02 :	85.0	0.0	1700.0	0.0
loop 03 :	10.0	0.0	1700.0	0.0
loop 04 :	10.0	0.0	1700.0	0.0
loop 05 :	55.0	0.0	1700.0	0.0
loop 06 :	55.0	0.0	1700.0	0.0

This page is used for alarm parameter setting. Three limit values per channel can be entered. The monitoring mode (min., max. limit value monitoring or tolerance check) is determined by KS vario configuration and parameter setting.

The limit value configuration is indicated only in colours by the operating terminal.

- low            low limit value monitoring is active
- high          high limit value monitoring is active
- tol            checking for min. and max. tolerance related to the setpoint is active
- off            channel limit value monitoring is switched off

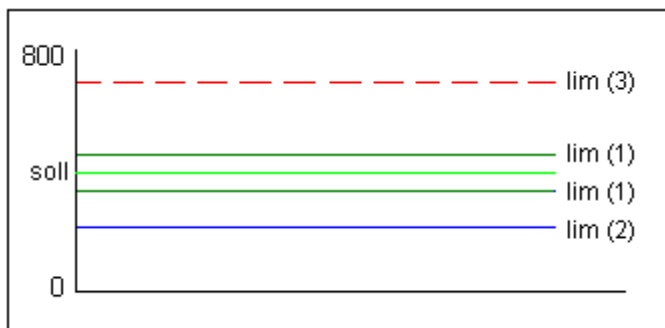

Example: Channels 1..4 of the operating page shown above

**g** Dependent on KS vario configuration, min./max. limit values related to the setpoint, or absolute limit values can be effective.

**Input:**

The setpoints of the active alarms can be changed as follows:  
 Scroll through the display using the arrow keys, until the relevant channel is displayed. Touch the relevant value to display a keypad for entry.

**a** **KS vario must always be configured accordingly in advance !**

## Parameter setting and special dialogues

### *The parameter page*

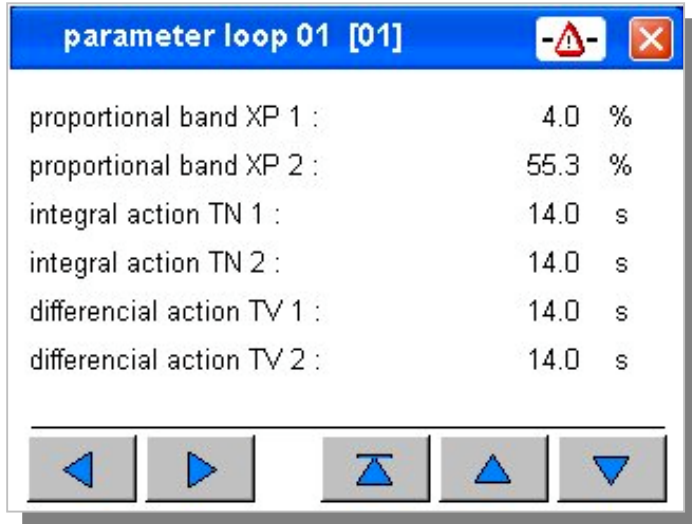

The parameter page provides a survey of important channel parameter settings.

Use the arrow keys ( up/down ) to scroll through the list.

Touch arrow keys ( left/right ) for switch-over to the next controller channel.

When touching a parameter value, a keypad for input of the relevant value is displayed.

**Self-tuning**

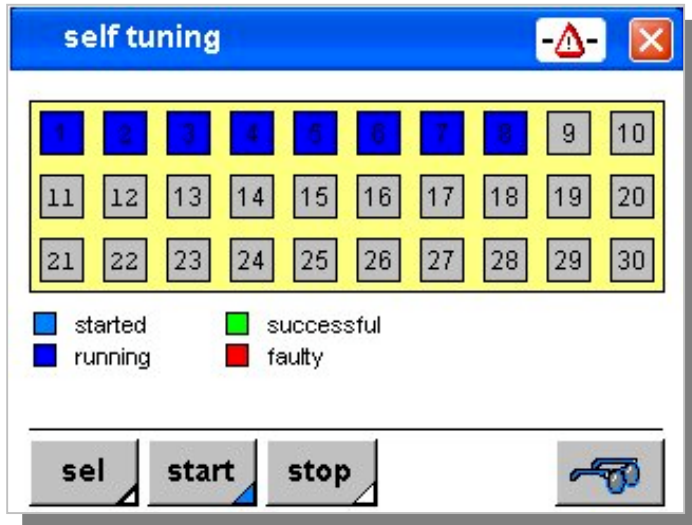

The terminal supports individual and groupwise controller self-tuning. Start channel selection using button [ sel ]. For single self-tuning, select the relevant channels from the upper list by touching with your finger. Self-tuning groups defined in KS vario can be selected via [OptGrp 1 .. OptGrp 4]. After selecting the required zone, the choice can be activated in KS vario by touching button [ Start ]. During self-tuning, further self-tuning attempts can be started with [ Sel ] and [ Start ]. Touching button [ stop ] cancels all running self-tuning attempts.

**G** For self-tuning, the relevant controllers must be switched on. When all selected controllers are switched off, button [ hand ] is displayed. Touching this button will switch on all selected controllers in manual mode with correcting variable=0.

Unless the select function is active, status display of the relevant channel is possible by touching a channel field.

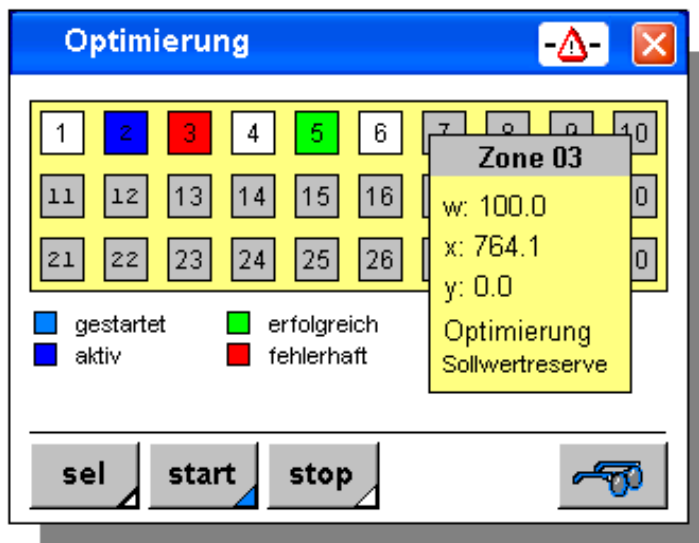

**Group operation**

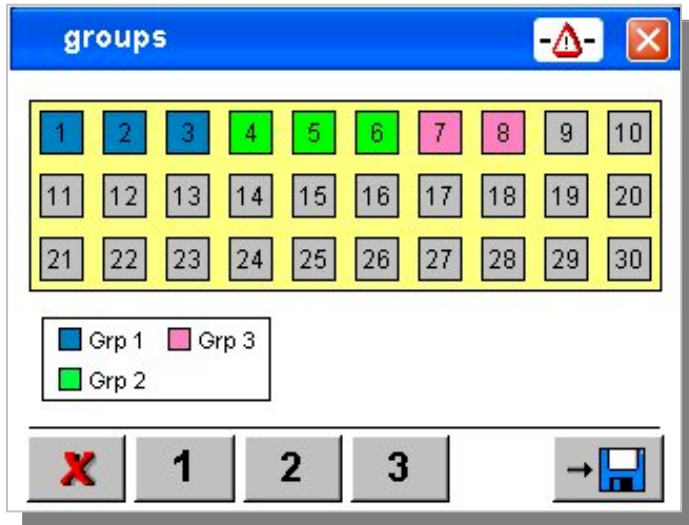

Max. three groups can be formed for partial switch-on/off of a system consisting of several parts. To compose a group, select the controllers to be included in a group on the page for group configuration and actuate button [ 1 ], [ 2 ] or [ 3 ] dependent on group. Button [ X ] can be used to remove selected controllers from a group.

**g** If groups are defined, the relevant buttons for group selection are displayed on the operating page.

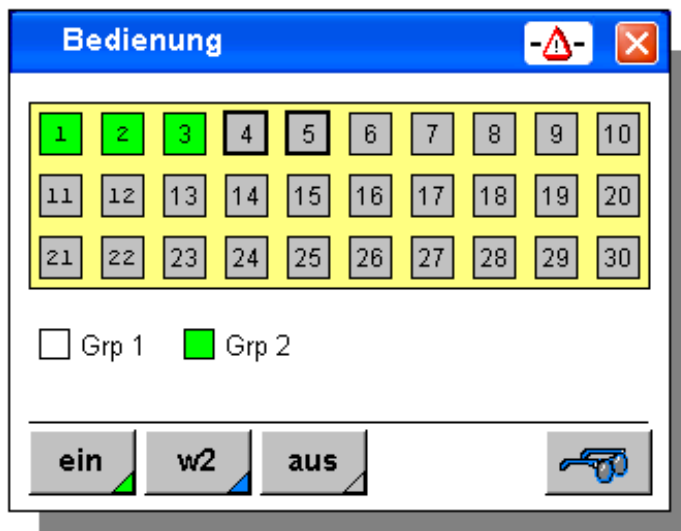

**g** Please, store the group setting, if it should be used continuously !

**Copying settings**

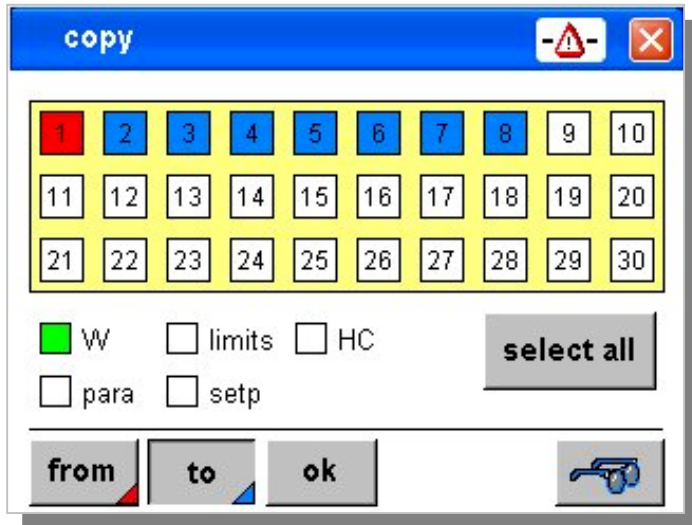

For utmost management efficiency of the multitude of parameter settings, copying of the settings to other controller channels is possible. For this purpose, the copying dialogue page is used. Setpoints, parameters and limit values can be copied.

Procedure:

- Adjust all relevant values for a controller channel.
- Open the operating page for copying.
- Select the settings which should be copied (W, limits, ... )
- Touch button [ from ] and select the source.
- Now, touch button [ to ] and select the controllers, which shall be provided with identical values.
- The entry can be accelerated by touching button [ select all ].
- Touch button [ ok ] to copy the values.

W	copies the effective setpoint
limits	copies tol(1), tol(2) and max. values
HC	copies the heating current limit value
para	copies parameter TN, TV, XP, T
setp	copies SP2, boost, start-up, gradient

## Recipes

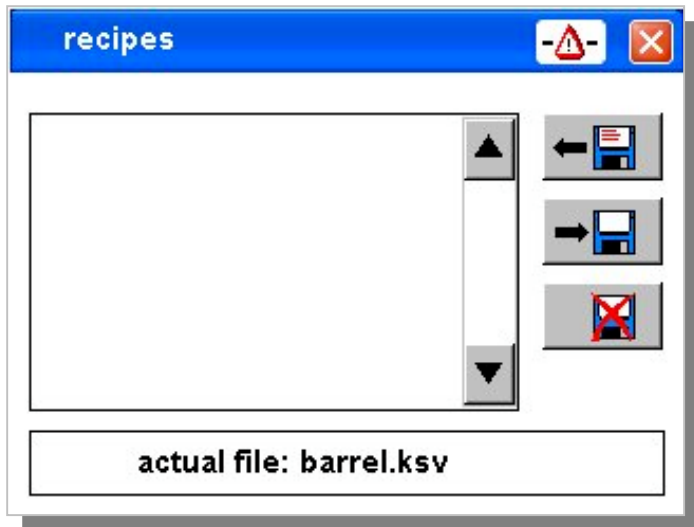

Settings can be stored in the terminal as recipes.

### Storing:

Touch line "File: \_\_\_" and enter a file name.

Existing files which should be overwritten can be selected simply from the list. Touch [ write ] to save the data.

### Read:

Select a data set from the list.

Touch [ read ] for data reading.

### Deleting data sets:

Select a data set from the list.

Touch [ delete ] to delete the data.



Recipes are saved as files on the internal Flash memory.

Recipe files always have extension (.ksv).

**Passwords**

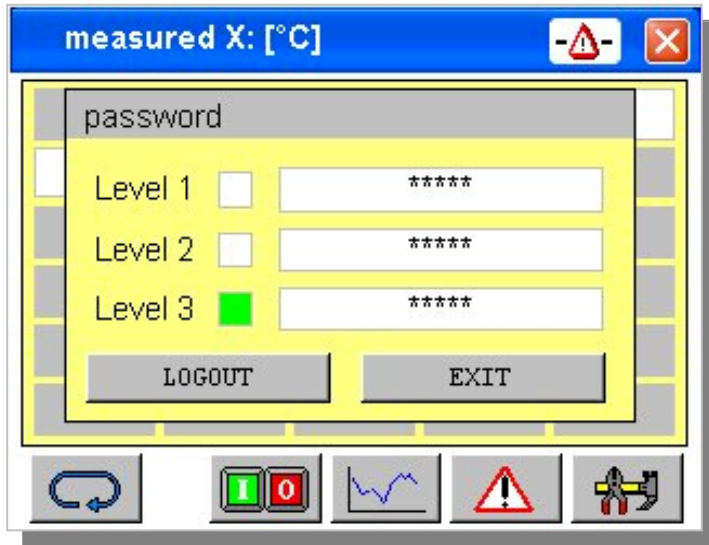

Data entries via the KS vario operating terminal can be interlocked by means of three access levels. Opening a password dialogue is possible via the parameter menu on the main operating page. This dialogue offers three user levels. If a terminal is new, no passwords are stored and access to all data is possible (level 3).

To activate the user management, passwords for disabling user levels must be stored.

**USER LEVEL**

Level 1:	setpoints, heating on/off, ...
Level 2:	parameters, limit values, ...
Level 3:	operating terminal configuration

**Activating a user level and changing passwords:**

The password of the instantaneously enabled level and of the lower levels can be changed. Definition of a new password is by entering the password for the relevant user level twice. “#” should be used as a separator between the two entries.

**Example**

Input of "1234#1234" on line "Level 3" defines "1234" as a new password for user level 3. To delete a password, simply enter "#".

**Logging in and out:**

Open the password dialogue via the parameter menu on the survey page. If log-in was already done, or in case no passwords are stored, the instantaneous user level is displayed in the status fields.

For logging out, simply touch [ LOGOUT ]  
 To log in, enter the valid password in the field for the required user level.  
 Touch [ EXIT ] for exit from the dialogue.



## Technical data

---

### COMPUTER

---

CPU: Arm9 SC2410 266 MHz  
Cooling without fan  
64 Mbyte on-board RAM  
64 Mbyte on-board flash memory

---

### DISPLAY

---

5,7-inch colour FSTN LC display  
QVGA 320 x 240-pixel resolution  
256 colours 165 cd/qm  
resistive touch

---

### INTERFACES

---

#### **Connector for KSVARIO Modbus coupler (COM3)**

Type: RS485, 9-pole sub-D connector  
Max. cable length: 1000m

#### **Serial Interface reserve (COM2)**

Type: V.24 / RS232, 9-pole sub-D connector  
Max. cable length: 12m

#### **Connector for KSVARIO BlueControl interface (COM1)**

Type: V.24 / RS232, 9-pole sub-D connector  
Max. cable length: 3m

#### **Network**

Ethernet interface (10/100 Base-T)

#### **USB interface**

1 x USB client  
1 x USB host

#### **Memory extension**

1 x type I compact flash card

---

### POWER SUPPLY

---

Operating voltage: 24 V DC  $\leq$  12W  
Protection class III (protective low voltage)

---

### ENVIRONMENTAL CONDITIONS

---

Permissible temperatures  
Operating temperature 0...50°C  
Storage/transport -20...60 °C

#### **CLIMATIC CATEGORY:**

Relative category: 10 ..95 % at 40°C, no condensation

---

### INFLUENCING FACTORS

---

#### **Supply voltage**

Without effect. In case of mains failure, the configuration data are stored in flash PROM.

#### **Vibration test**

sinusoidal vibrations according to  
IEC 60068-2-6; EN 60068-2-6;  
2g load, 1 h for each space direction

### **Shock test**

according to IEC 60068-2-27; EN 60068-2-27  
10g load for 11 ms, half sinusoidal wave,  
three shocks in each space direction and orientation

---

## **ELECTROMAGNETIC COMPATIBILITY**

---

### **Noise Immunity Test according to EN 50082-2**

All interface cables must be screened.

### **Noise Emission Test according to EN 50081-2**

Noise emission of housing: EN 55011 Class A

---

## **GENERAL**

---

### **Housing**

Dimensions (WxHxD): 195x148x40 [mm]  
Panel cut-out: 188x141 [mm]

### **Weight**

approx. 0,8 kg

### **Protection mode**

Front panel: IP 65  
Rear: IP 20

### **Safety**

Conforms to EN 61010-1 (VDE 0411-1):  
Overvoltage category II  
Degree of contamination 2  
Operating voltage range 50 V  
Protection class III

### **CE marking**

Meets the European Directives for electromagnetic compatibility and low voltage

### **Accessories delivered with the units**

Connecting terminal for the operating voltage  
Keyboard adaptor  
Mounting accessories



