

USER'S MANUAL

Rev. 03/2022

REVO SX

Solid-State Relay
From 50 to 90A

002

M-RSX-50-90



CD Automation S.r.l.

Via Picasso, 34/36 - 20025 Legnano (MI)- Italy

Tel. +39 0331 577479 - Fax +39 0331 579479

E-mail: info@cdautomation.com - Web: www.cdautomation.com



Declaration of conformity

Declaration of conformity-Dichiarazione di Conformità

PRODUCT MANUFACTURER/ PRODUTTORE:



CD Automation S.R.L.
Controllers, Drives & Automation

Via Picasso, 34/36 - 20025 Legnano (MI)- Italy
P.I. 08925720156 -Tel. +39 0331 577479 - Fax +39 0331 579479
E-mail: info@cdautomation.com - Web: www.cdautomation.com

Declare that the product / Dichiaro che il prodotto:

REVO SX 50A-90A

PRODUCT DESCRIPTION: Electric power control
SCOPE OF APPLICATION: Thermal control process
DESCRIZIONE DEL PRODOTTO: Unità di controllo potenza elettrica
UTILIZZO: Controllo processi termici

FULFILLS THE REQUIREMENTS OF THE STANDARD:

Electrical safety Standard	EN60947-1: 2007 + A1 2011, A2 2014 EN60947-4-3: 2014
Generic Emission standard	EN60947-4-3: 2014 Group 1 Class A emissions
Generic Immunity standard	EN60947-4-3: 2014 Industrial Immunity

SODDISFA I REQUISITI DELLA NORMA:

Specifica di sicurezza	EN60947-1: 2007 + A1 2011, A2 2014 EN60947-4-3: 2014
Specifica sulle emissioni	EN60947-4-3: 2014 gruppo 1 emissioni classe A
Specifica sulle Immunità	EN60947-4-3: 2014 Immunità industriale

CDAutomation declares that the products above mentioned are conforming to the directive
CDAutomation dichiara che i prodotti sopra menzionati sono conformi alla direttiva
Alla direttiva Bassa Tensione (low Voltage) **EMC directive updated 2014/30/EU,**
Low Voltage Directive updated 2014/35/EU

Issued on: 20/03/2017
Data di emissione: 20/03/2017







Amministratore Unico e
Legale Rappresentante
Simone Brizzi

Important warnings for safety

This chapter contains important information for the safety. The not observance of these instructions may result in serious personal injury or death and can cause serious damages to the Thyristor unit and to the components system included.

The installation should be performed by qualified persons.

In the manual are used symbols to give more evidence at the notes of safety and operativity for the attention for the user:

	This icon is present in all the operational procedures where the Improper operation may result in serious personal injury or death by Electrical Shock Hazard Symbol (a lightning bolt in a triangle) precedes an electric shock hazard CAUTION or WARNING safety statement.
	Warning or Hazard that needs further explanation than the label on unit can provide. Consult User's Guide for further information.
	Unit is compliant with European Union directives. See Declaration of Conformity for further details on Directives and Standards used for Compliance.
	If available, unit is a Listed device per Underwriters Laboratories. It has been investigated to ANSI/UL® 508 standards for Industrial Control Switches and equivalent to CSA C22.2 #14. For more detail search for File E231578 on www.ul.com
	ESD Sensitive product, use proper grounding and handling techniques when installing or servicing product.
	Do not throw in trash, use proper recycling techniques or consult manufacturer for proper disposal.

A **"NOTE"** marks a short message to alert you to an important detail.













A **"CAUTION"** safety alert appears with information that is important for protecting your equipment and performance. Be especially careful to read and follow all cautions that apply to your application.





















A **"WARNING"** safety alert appears with information that is important for protecting you, others and equipment from damage. Pay very close attention to all warnings that apply to your application.

Safety notes

 **WARNING!** To avoid damage to property and equipment, injury and loss of life, adhere to applicable electrical codes and standard wiring practices when installing and operating this product. Failure to do so could result in damage, injury and death.

 **AVERTISSEMENT!** Pour éviter d'endommager la propriété et l'équipement, les blessures et la perte de vie, respecter les codes électriques en vigueur et les pratiques de câblage standard au moment de l'installation et de l'utilisation de ce produit. Dans le cas contraire, cela peut entraîner la mort, des blessures graves ou des dommages.

-  **WARNING!** All service including inspection, installation, wiring, maintenance, troubleshooting, fuse or other user serviceable component replacement must be performed only by properly qualified personnel. Service personnel must read this manual before proceeding with work. While service is being performed unqualified personnel should not work on the unit or be allowed in the immediate vicinity.
-  **AVERTISSEMENT!** Tous les services, y compris l'inspection, l'installation, le câblage, l'entretien, le dépannage, le remplacement de fusibles ou d'autres composants pouvant être réparés par l'utilisateur, doivent être effectués uniquement par un personnel d'entretien qualifié. Le personnel de service doit lire ce manuel avant d'effectuer tout travail. Pendant que l'entretien est exécuté, tout personnel non qualifié ne doit effectuer de travail sur l'appareil ni se trouver à proximité.
-  **WARNING!** When in use the power controller is connected to dangerous voltages. Do not remove the protective covers without first disconnecting and preventing power from being restored while servicing the unit.
-  **AVERTISSEMENT!** Au moment de l'utilisation, le régulateur de puissance est connecté à des tensions dangereuses. Ne retirer aucun couvercle de protection sans d'abord débrancher l'appareil et ainsi empêcher l'alimentation d'être rétablie pendant l'entretien.
-  **WARNING!** Do not use in aerospace or nuclear applications.
-  **AVERTISSEMENT!** Ne pas utiliser pour les applications aérospatiales ou nucléaires.
-  **WARNING!** The units are not developed to manage capacitive and inductive loads.
-  **AVERTISSEMENT!** Les unités ne sont pas développées pour la conduite de charges capacitatives et inductives.
-  **WARNING!** The power controller's protection rating is IP20 with all covers installed and closed. It must be installed in an enclosure that provides all the necessary additional protections appropriate for the environment and application.
-  **AVERTISSEMENT!** L'indice de protection du régulateur de puissance est de IP20 lorsque les couvercles sont installés et fermés. L'appareil doit être installé dans une enceinte qui assure toute la protection supplémentaire nécessaire pour l'environnement et l'application.
-  **WARNING!** Ground the power controller via the provided protective earth grounding terminal. Verify ground is within impedance specifications. This should be verified periodically.
-  **AVERTISSEMENT!** Mise à la terre du régulateur de puissance par le biais de la borne de prise de terre de protection fournie. Vérifier que la prise de terre est conforme aux spécifications de l'impédance. Cela doit être vérifié périodiquement.
-  **WARNING!** Electric Shock Hazard: when the power controller has been energized, after shutting off the power, wait at least one minute for internal capacitors to discharge before commencing work that brings you in to contact with power connections or internal components.
-  **AVERTISSEMENT!** Risque de décharges électriques: lorsque le régulateur de puissance est mis sous tension, après avoir été éteint, attendre au moins une minute pour que les condensateurs internes se déchargent avant de commencer tout travail incluant le contact avec les connexions électriques ou les composants internes.
-  **WARNING!** The installation must be protected by electromagnetic circuit breakers or by fuses. The semiconductor fuses located inside the power controller are classified for UL as supplementary protection for semiconductor devices. They are not approved for branch circuit protection.
-  **AVERTISSEMENT!** L'installation doit être protégée par des disjoncteurs électromagnétiques ou des fusibles. Les fusibles pour semi-conducteurs situés à l'intérieur du régulateur de puissance sont classés UL comme protection supplémentaire pour les dispositifs pour semi-conducteurs. Ils ne sont pas approuvés pour la protection des circuits de dérivation.
-  **WARNING!** When making live voltage or current measurements, use proper personal protective equipment for the voltages and arc-flash potentials involved.

-  **AVERTISSEMENT!** Au moment de relever des mesures de tension ou de courant en direct, utiliser un équipement de protection individuelle approprié pour les tensions et les potentiels d'arc électrique concernés.
-  **WARNING!** Verify the voltage and current ratings of the power controller are correct for the application.
-  **AVERTISSEMENT!** Vérifier que les valeurs de tension et de courant du régulateur de puissance sont correctes pour l'application.
-  **CAUTION:** To avoid compromising the insulation, do not bend wire or other components beyond their bend radius specifications.
-  **ATTENTION:** Pour éviter de compromettre l'isolation, ne pas plier le fil ou tout autre composant au-delà de ses spécifications en matière de rayon de courbure.
-  **CAUTION:** Protect the power controller from high temperature, humidity and vibrations.
-  **ATTENTION:** Protéger le régulateur de puissance contre les températures élevées, l'humidité et les vibrations.
-  **CAUTION:** The power controller warranty is void if the tested and approved fuses are not used.
-  **ATTENTION:** La garantie du régulateur de puissance est nulle si aucun fusible testé et approuvé n'est utilisé.
-  **CAUTION:** Only trained and authorized personnel should access and handle the internal electronics and they must follow proper electro-static prevention procedures.
-  **ATTENTION:** Seul le personnel formé et autorisé peut accéder aux composants électroniques internes et les gérer, et il doit se conformer à des procédures de prévention électrostatique appropriées.
-  **CAUTION:** Install an appropriately sized RC filter across contactor coils, relays and other inductive loads.
-  **ATTENTION:** Installer un filtre RC de dimensions appropriées sur les bobines du contacteur, les relais et autres charges par induction.
-  **CAUTION:** The thyristor units here described have been designed for use with sinusoidal networks with nominal frequency 50-60 Hz. Any application with NON-SINUSOIDAL, distorted or disturbed networks could compromise the correct operation of the unit.
-  **ATTENTION:** Les unités de thyristors décrites ici ont été conçues pour être utilisées avec des réseaux sinusoïdaux d'une fréquence nominale de 50 à 60 Hz. Toute application utilisant des réseaux NON SINUSOÏDAUX, déformés ou perturbés peut compromettre le bon fonctionnement de l'appareil.
-  **NOTE:** Provide a local disconnect to isolate the power controller for servicing.
-  **REMARQUE:** Fournir une déconnexion locale afin d'isoler le régulateur de puissance pour l'entretien.
-  **NOTE:** The nominal current is specified for ambient temperatures at or below 40° C. Ensure the application design allows for adequate cooling of each power controller. The power controller must be mounted vertically. The cooling design must prevent air heated by one power controller from causing power controllers mounted above to exceed the ambient operating temperature limit. When power controllers are mounted side by side allow a minimum spacing of 15mm between them.
-  **REMARQUE:** Le courant nominal est précisé pour des températures ambiantes égales ou inférieures à 40°C. S'assurer que la conception de l'application permette le refroidissement adéquat de chaque régulateur de puissance. Le régulateur de puissance doit être monté verticalement. La conception de refroidissement doit empêcher l'air chauffé par le régulateur de puissance de dépasser la limite de température de fonctionnement ambiante de la part des régulateurs de puissance montés au-dessus. Lorsque les régulateurs de puissance sont montés côte à côte, il faut conserver un espacement minimal de 15 mm entre les deux.
-  **NOTE:** Use only copper cables and wires rated for use at 90°C or greater.
-  **REMARQUE:** N'utiliser que des câbles et des fils en cuivre pour l'utilisation à 90°C ou plus.



Maintenance

In order to have a corrected cooling, the user must clean the heat-sink and the protective grill of the fans. The frequency of this servicing depends on environmental pollution.

Also check periodically if the screw for the power cables and safety earth are tightened correctly (See Connection Diagram).

Warranty condition

Producer gives a 12 months warranty to its products.

The warranty is limited to repairing and parts substitution in our factory and does exclude products not properly used and fuses.

Warranty does not include products with serial numbers deleted. The faulty product should be shipped to Producer at customer's cost and our Service will evaluate if product is under warranty terms.

Substituted parts remain of Producer property.



Return Material Authorization (RMA)

Customers wishing to return any items, whether they are incorrectly supplied, faulty or damaged in transit, must first complete a Return Material Authorisation (RMA) form to obtain an RMA number from the Service Department.

A full repair service is available for customers. Prior to submitting the RMA form and returning products, customers are recommended to contact the technical support team to determine whether the issue can be resolved with telephone support.

How the RMA service works

The RMA form and details are available on our web sites:

<https://www.cdautomation.com/returns-material-authorisation/>

When completing the RMA form, please be as specific as possible about the problem, including any pertinent application details. The more information given, the more quickly and more thoroughly the problem can be solved. The minimum information required is:

1. The Full Model Number
2. Quantity of units being returned
3. The units Serial Number(s)
4. A description of the problem ("faulty" or "unknown" is not sufficient)



Summary

- Declaration of conformity.3
- Important warnings for safety4
- Maintenance7
- 1 Basic Connections and sizing9
- 2 Identification and Order Code10
 - 2.1 Identification of the unit10
 - 2.2 Order Code.11
- 3 Technical Specifications.12
 - 3.1 General features12
 - 3.2 Input features12
 - 3.3 Output features (power device)12
 - 3.4 Environmental installation conditions12
 - 3.5 Fan Specification12
 - 3.6 Derating Curve13
 - 3.7 Calculating flow capacity of the fan.13
- 4 Installation14
 - 4.1 Dimensions and weight15
 - 4.2 Fixing holes15
- 5 Wiring instructions16
 - 5.1 Command Terminals (2 phases)17
 - 5.2 Connection Diagram (2 phases)18
 - 5.3 Command Terminals (3 phases)19
 - 5.4 Connection Diagram (3 phases)20
- 6 Firing type.21
 - 6.1 Zero Crossing21
- 7 Internal Fuse22

1 Basic Connections and sizing

Wiring with resistive load

$$I = \frac{P}{V}$$

V = Nominal voltage of the load

I = Nominal current of the load

P = Nominal power of the load

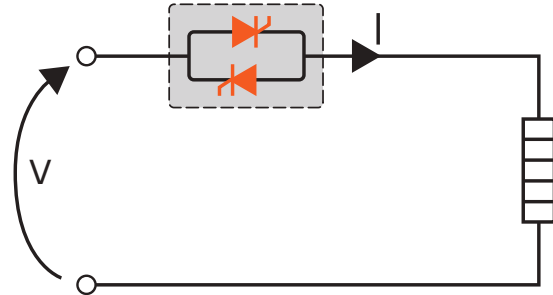

Star + neutral wiring with resistive load

$$I = \frac{P}{1,73V}$$

V = Nominal voltage of the load

I = Nominal current of the load

P = Nominal power of the load

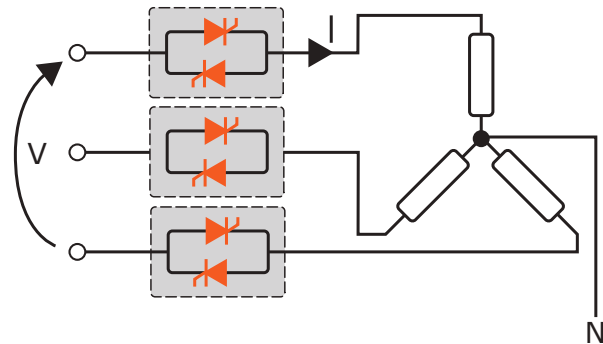

2

Identification and Order Code

2.1 Identification of the unit



Caution: Before to install, make sure that the Thyristor unit have not damages. If the product has a fault, please contact the dealer from which you purchased the product.

The identification label give all the information regarding the factory settings of the Thyristor unit, this label is on the unit, like represented in figure.

Verify that the product is the same thing as ordered.

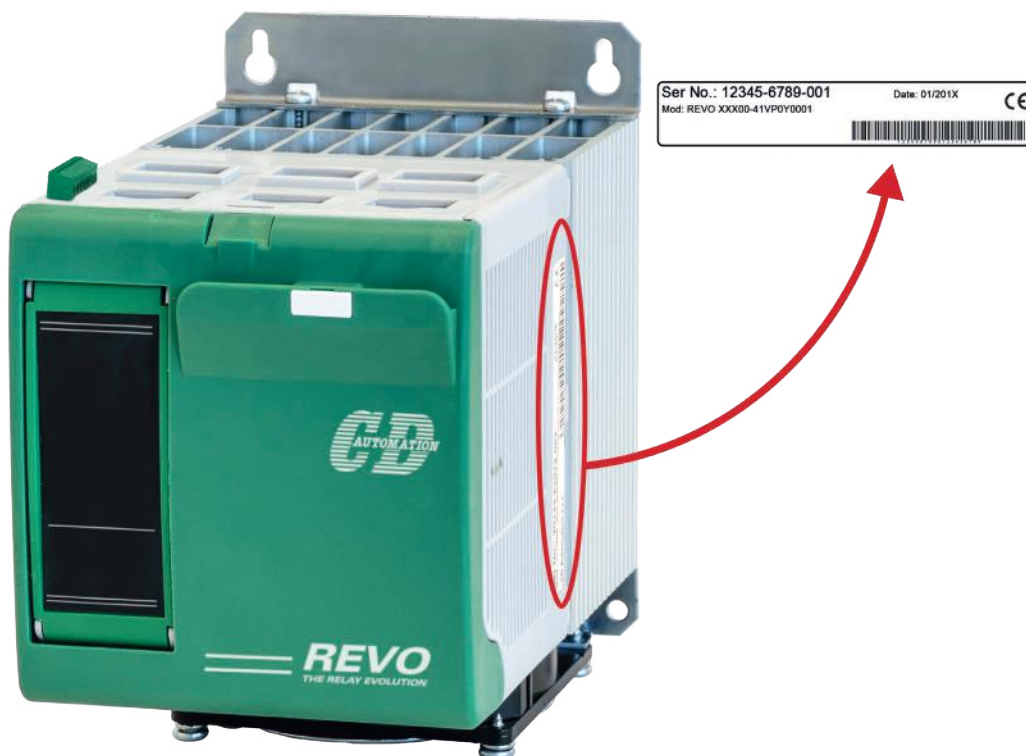

2.2 Order Code

	1	2	3	4	5	6		7	8	9	10	11	12	13	14	15	16
REVO SX	R	S	X	-	-	-	-	-	-	-	-	-	-	-	-	-	-

NUMBER OF ZONES X CURRENT RATING	4	5	6
description	code		
2 zones 50A each	2	5	0
2 zones 60A each	2	6	0
2 zones 75A each	2	7	5
2 zones 90A each	2	9	0
3 zones 50A each	3	5	0
3 zones 60A each	3	6	0
3 zones 75A each	3	7	5
3 zones 90A each	3	9	0

MAX VOLTAGE	7
description	code
480V	4
600V	6

VOLTAGE SUPPLY AUX	8
description	code
No Auxiliary Voltage	0

INPUT	9
description	code
SSR	S

FIRING	10
description	code
Zero Crossing	Z

CONTROL MODE	11
description	code
Open Loop	0

FUSES & OPTION	12
description	code
Integrated fuses	F

FAN VOLTAGE	13
description	code
Standard: 24Vdc Fan	3

APPROVALS	14
description	code
CE EMC For European Market	0

MANUAL	15
description	code
None	0
Italian	1
English	2
German	3
French	4

VERSION	16
description	code
Version 1	1

3 Technical Specifications

3.1 General features

Cover and Socket material: PolymericV2
 Utilization Category: AC-51 AC-55b AC-56A
 IP Code: 20
 Method of Connecting: 2 or 3 single phase load

3.2 Input features

Digital Input: 4 ÷ 30Vdc 5mA Max (ON ≥4Vdc OFF <1Vdc) 5Hz max

3.3 Output features (power device)

Current	Nominal Voltage range (Ue)	Repetitive peak reverse voltage (Uimp)	Latching current	Max peak one cycle	Leakage current	FUSE I²T value Suggested A²s (at 500V)	Frequency range	Power loss Thyristor + Fuse 2 zones	Power loss Thyristor + Fuse 3 zones	Isolation Voltage (Ui)
(A)	(V)	(600V)	(mAeff)	(10 msec.) (A)	(mAeff)	tp= 10msec	(Hz)	I =Inom (W)	I =Inom (W)	(Vac)
50	24÷600	1600	600	1900	15	4305	47÷70	130	195	3000
60	24÷600	1600	600	1900	15	4305	47÷70	156	234	3000
75	24÷600	1600	600	1900	15	4305	47÷70	195	292	3000
90	24÷600	1600	600	1900	15	4305	47÷70	234	351	3000

3.4 Environmental installation conditions

Ambient temperature: 0-40°C (32-104°F) at nominal current. Over 40°C-104°F use the derating curve (max 50°C).
 Storage temperature: -25°C to 70°C -13°F to 158°F
 Installation place: Don't install at direct sun light, where there are conductive dust, corrosive gas, vibration or water and also in salty environmental.
 Altitude: Up to 1000 meter over sea level. For higher altitude reduce the nominal current of 2% for each 100m over 1000m
 Humidity: From 5 to 95% without condense and ice
 Pollution Level: Up to 2nd Level ref. IEC 60947-1 6.1.3.2

3.5 Fan Specification

Supply: 24 Vdc Power 7W (1 Fan)

3.6 Derating Curve

The nominal current of the units in specification are referred to continuous service at 40°C ambient temperature. For higher temperature multiply the nominal current times derating coefficient K below represented:

$$I_{max} = I_{nominal} \times K$$

● Derating

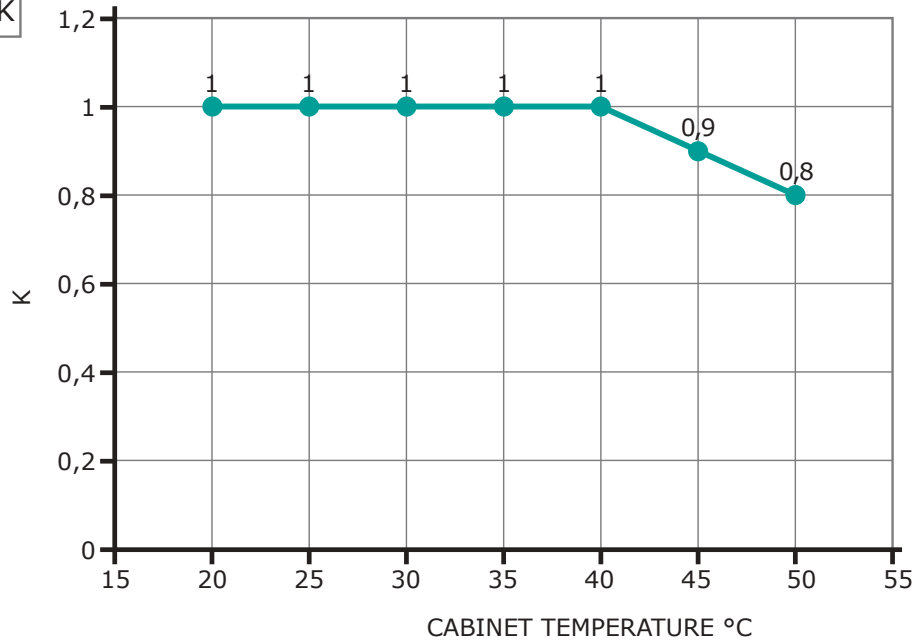

For higher cabinet temperature (more than 50°C) contact the producer of the unit

3.7 Calculating flow capacity of the fan

All the thyristor units when are in conduction produces power loss that is dissipated inside cubicle in terms of heating. Due to this fact the internal temperature of cubicle is higher than ambient temperature. To be cooled the thyristor need of fresh air cooling and to do it is normally used a fan mounted on the front door or on the roof of the cabinet.

Procedure to size **Fan air mass flow (V)**: see power loss for each thyristor and fuse mounted indicated in the manual related to the current (Output feature and Internal fuse Chapter).

$V = f * \frac{Q_v}{t_c - t_a}$	Qv = total power losses (w) (thyristor + fuse power loss)	Altitude 0:100 meters f = 3.1 m3k/W/h 100:250 meters f = 3.2 m3k/W/h 250:500 meters f = 3.3 m3k/W/h 500:750 meters f = 3.4 m3k/W/h
	ta = ambient temperature (°C) tc = cabinet temperature (°C) V = fan air mass flow (m3/h) f = altitude coefficient (see table on right)	



The formulas used are for information only and is not a substitute for a proper thermal rating done by a qualified person.

4 Installation

Before to install, make sure that the Thyristor unit have not damages.

If the product has a fault, please contact the dealer from which you purchased the product. Verify that the product is the same thing as ordered.

The Thyristor unit must be always mounted in vertical position to improve air cooling on heat-sink.

Maintain the minimum distances (*) in vertical and in horizontal as represented, *this area must be free from obstacle (wire, copper bar, plastic channel)*.

When more unit has mounted inside the cabinet maintain the air circulation like represented in figure without obstacle for the air flow.

Is necessary to install a fan to have better air circulation as calculated previously.

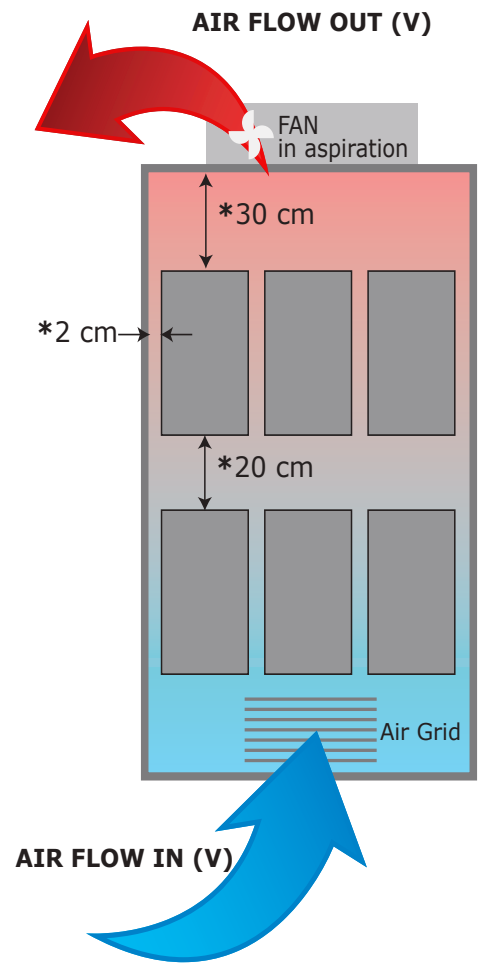

The V Air flow must be equal or more than the value calculated.

If the cabinet fan mounted by the customer have an air flow lower than the correct value the warranty will decay.

4.1 Dimensions and weight

Size: SR25
 W (mm): 116
 H (mm): 180
 D (mm): 183
 Weight (kg): 2.35

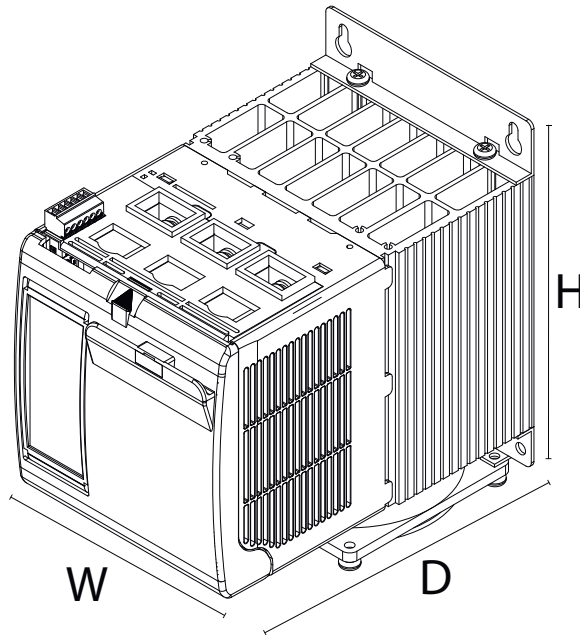

4.2 Fixing holes

Size: SR25

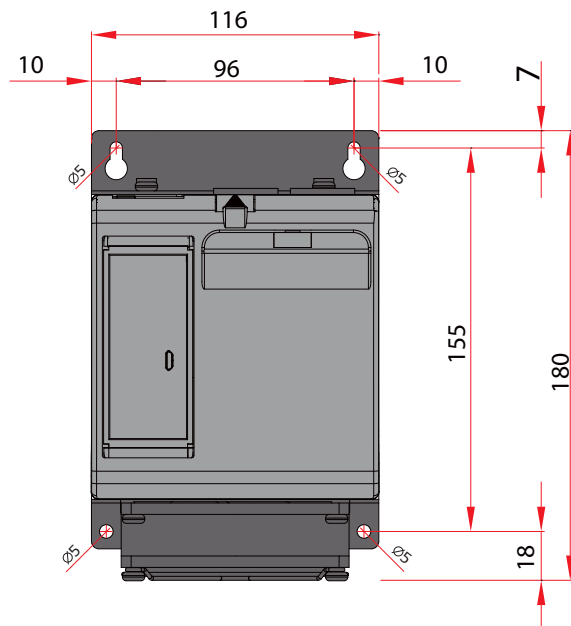

5 Wiring instructions

The Thyristor unit could be susceptible to interferences lost by near equipments or by the power supply, for this reason in accord to the fundamental practices rules is opportune take some precautions:

- The coil contactor, the relays and other inductive loads must be equipped with opportune RC filter.
- Use shielded bipolar cables for all the input and output signals.
- The signal cables must not be near and parallel to the power cables.
- Local regulations regarding electrical installation should be rigidly observed.

Use 90°C copper (CU) conductor only, wire ranges (AWG), wire terminal type (ZMVV), terminal tightening torque in the table below.

Power cable torque (suggested)

Current (A)	Connector Type	Torque Lb-in (N-m)	Wire Range mm ² (AWG)	MAX Current Terminals	Wire Terminals UL Listed (ZMVV)
50 60 75 90	Screw M6	44.2 (5.0)	18 (5) 25 (3)	90A	Fork/Spade Terminal Copper Tube Crimp.Lug

Cable dimensions of the Command Terminals	0.5 mm ² (AWG 18)
Cable dimensions of the Earth (suggested)	6 mm ² (AWG 10)



Warning: Before connecting or disconnecting the unit check that power and control cables are isolated from voltage sources.

5.1 Command Terminals (2 phases)

RSX250 - RSX260 - RSX275 - RSX290



Warning: Before connecting or disconnecting the unit check that power and control cables are isolated from voltage sources.

5.1.1 Terminal block M1

Terminal	Description
1	Input Channel 1 +
2	Input Channel 1 -
3	Input Channel 2 +
4	Input Channel 2 -
5	Not connected
6	Not connected
7	Not connected
8	Not connected
9	Not connected
10	Not connected
11	- 24V Fan
12	+ 24V Fan

2 phases RSX250 - RSX260 - RSX275 - RSX290	
Terminal	Description
L1	Line Input 1
L2	Line Input 2
T1	Load Output 1
T2	Load Output 2

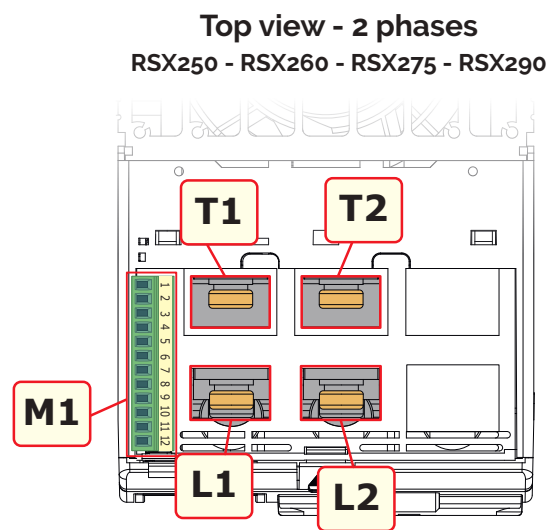

5.2 Connection Diagram (2 phases)

RSX250 - RSX260 - RSX275 - RSX290

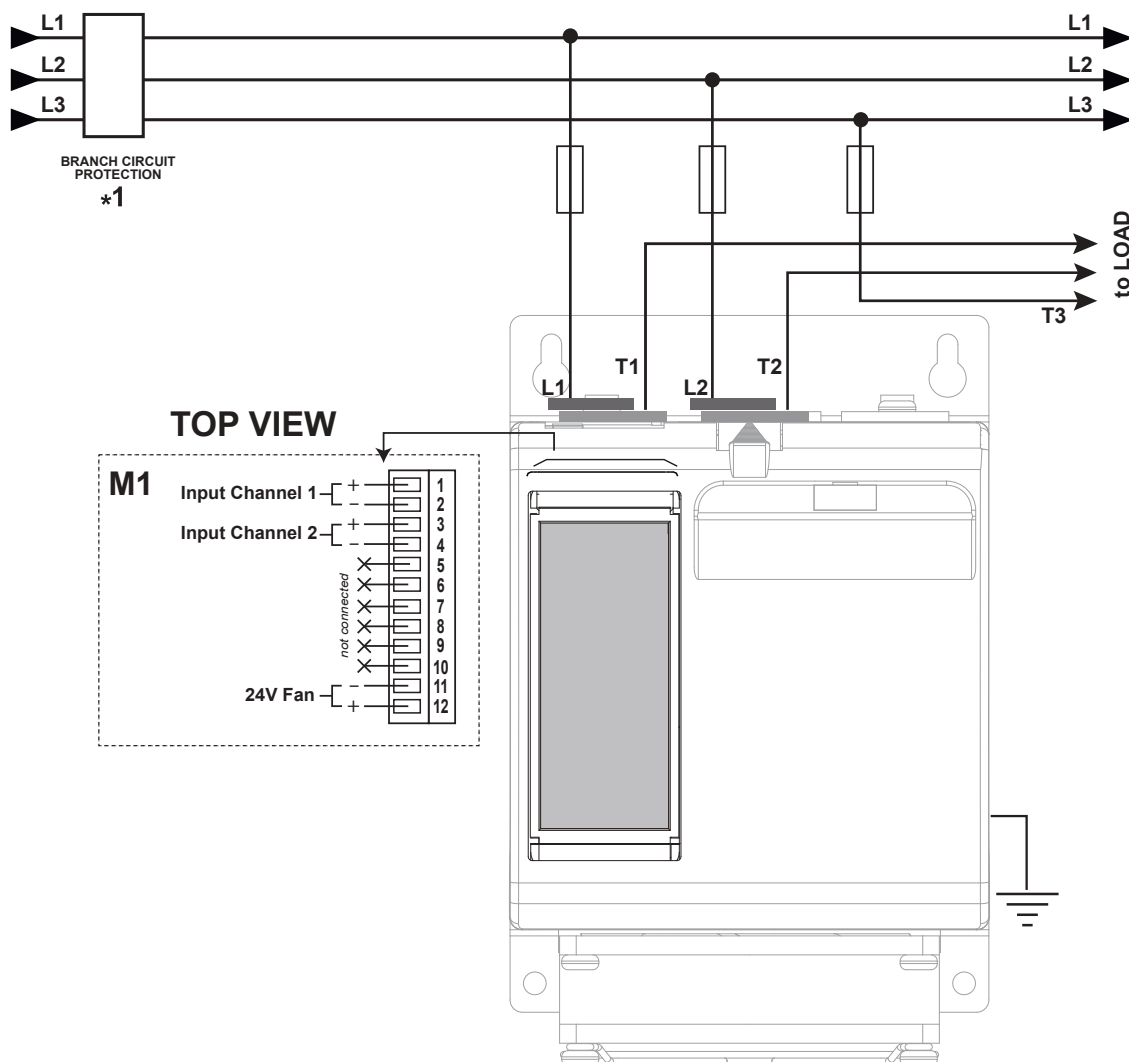

NOTE:

*1 The user installation must be protecting by electromagnetic circuit breaker or by fuse isolator. The Fuse must be branch circuit protection.

5.3 Command Terminals (3 phases)

RSX350 - RSX360 - RSX375 - RSX390



Warning: Before connecting or disconnecting the unit check that power and control cables are isolated from voltage sources.

5.1.1 Terminal block M1

Terminal	Description
1	Input Channel 1 +
2	Input Channel 1 -
3	Input Channel 2 +
4	Input Channel 2 -
5	Input Channel 3 +
6	Input Channel 3 -
7	Not connected
8	Not connected
9	Not connected
10	Not connected
11	- 24V Fan
12	+ 24V Fan

3 phases RSX350 - RSX360 - RSX375 - RSX390	
Terminal	Description
L1	Line Input 1
L2	Line Input 2
L3	Line Input 3
T1	Load Output 1
T2	Load Output 2
T3	Load Output 3

Top view - 3 phases
RSX350 - RSX360 - RSX375 - RSX390

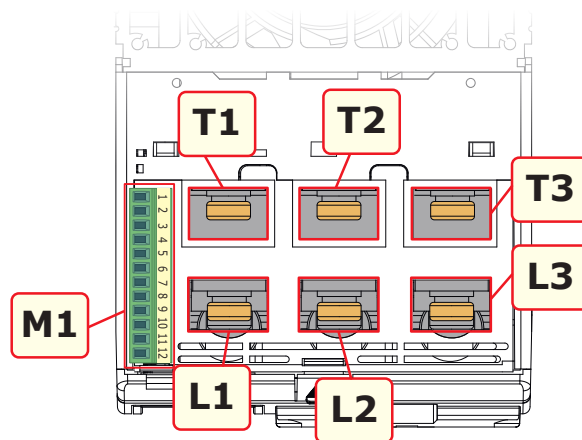

5.4 Connection Diagram (3 phases)

RSX350 - RSX360 - RSX375 - RSX390

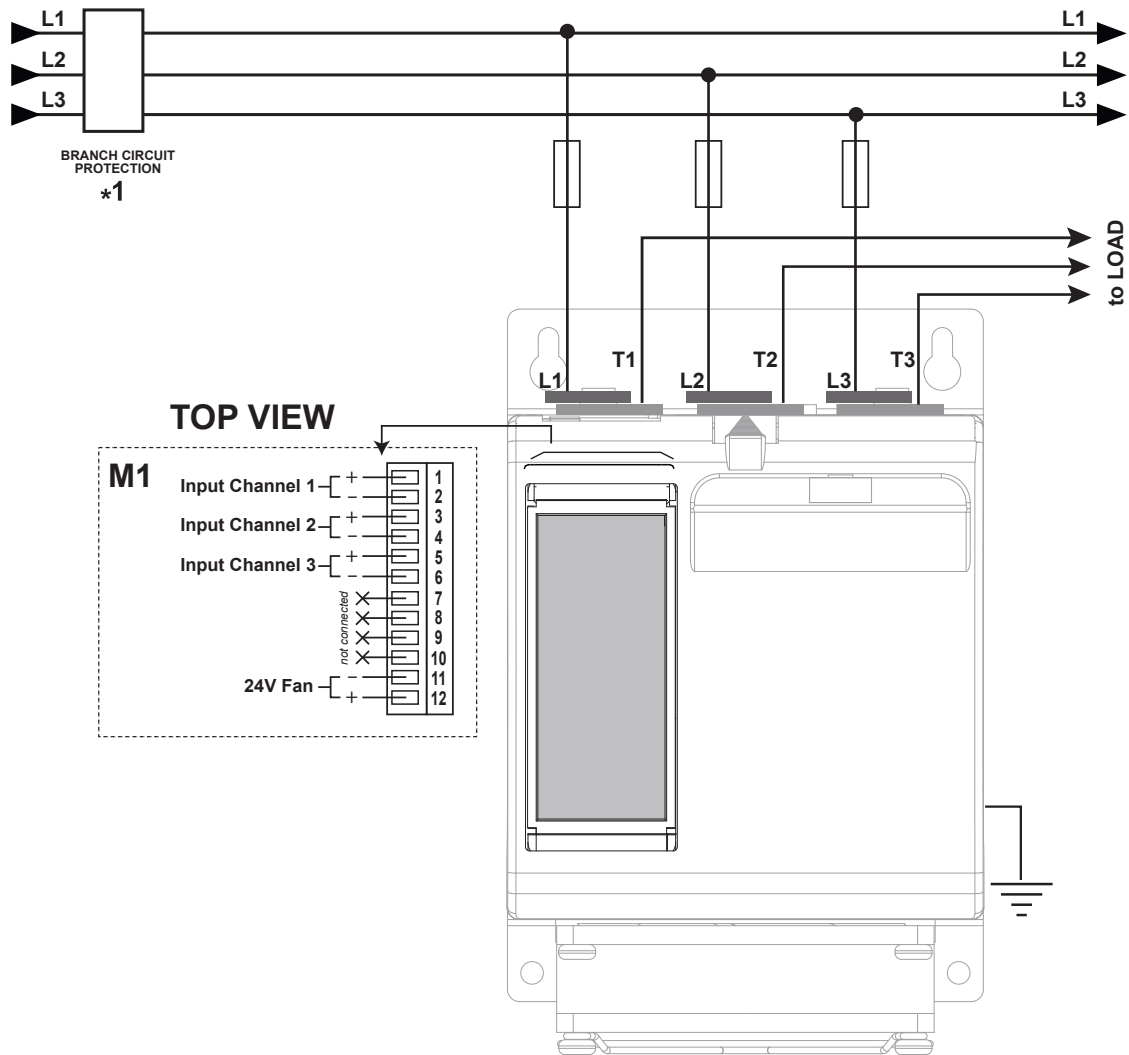

NOTE:

*1 The user installation must be protecting by electromagnetic circuit breaker or by fuse isolator. The Fuse must be branch circuit protection.

Open Delta

Star + Neutral

Single Phase

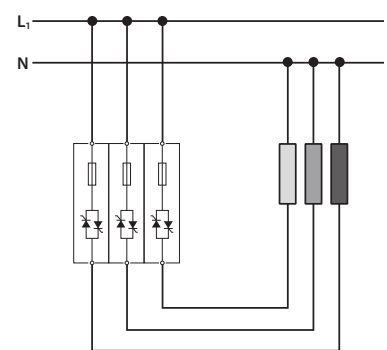
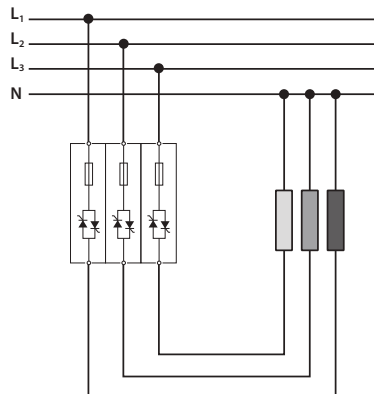
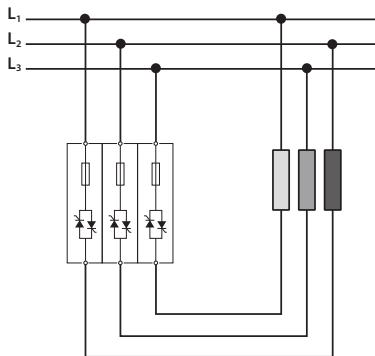

6 Firing type

Choose a correct firing type allows to optimize the thyristor unit for the installed load. The firing type has already configured in line with customer requirements that are defined in the Order Code. The Order Code is written on the identification label. However, if you wish to change the firing type you can use the software configurator or the Control Panel.



Caution: this procedure must be performed only by qualified persons.

6.1 Zero Crossing

ZC firing mode is used with Logic Output from temperature controllers and the Thyristor operates like a contactor. The Cycle time is performed by temperature controller. ZC minimizes interferences because the Thyristor unit switches ON-OFF at zero voltage.

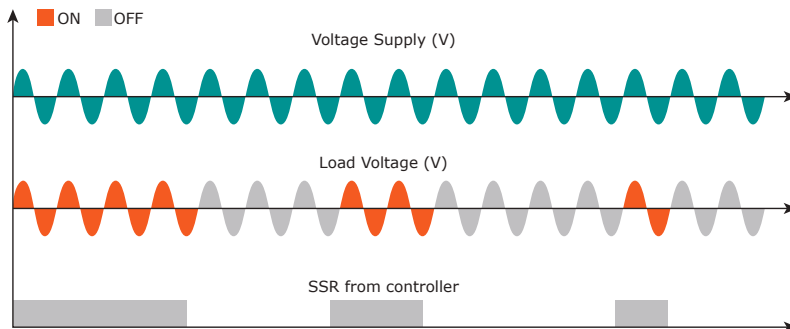

7 Internal Fuse

The thyristor unit have internal fuse extrarapid at low I²t for the thyristor protection of against the short-circuits. The Fuses must have I²t 20% less than thyristor's I²t. The warranty of thyristor is null if no proper fuses are used.

Type	Fuse Code Spare Part	Current (A _{RMS})	Vac	Fuse I ² t value Suggested A2s (at 500V)*	Fuse I ² t value Suggested A2s (at 690V)	Qty for each phase
050	FU5007306.80	80	690	1750	2500	1
060	FU5007306.80	80	690	1750	2500	1
075	FU5007306.100	100	690	2170	4400	1
090	FU5007306.100	100	690	2170	4400	1

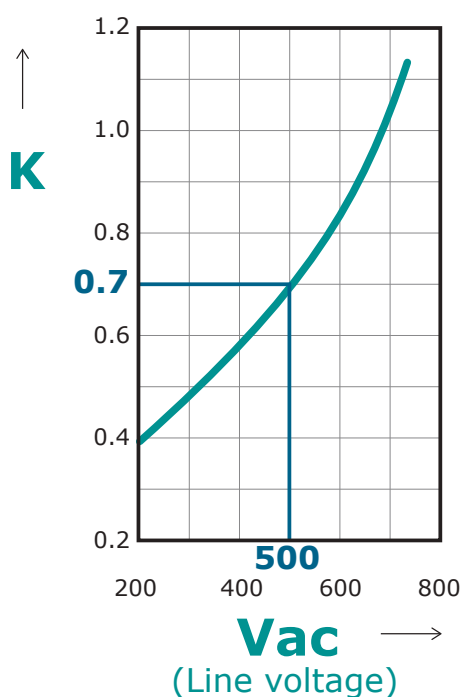

*I²t are multiplied for K value in function of Vac, at 500V K is equal to 0,7 (ex:3100 X 0,7 = 2170). At 690Vac K is equal to 1.

Fuses replacement:

Open the cover and remove the screws, then replace it with the correct fuse, use the screws with a proper suggested torque indicated below.

N° 2 M6x12mm for each fuse

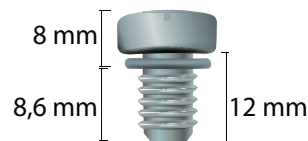

Use correct screws M6 x 12 mm.

Type	Screw	Torque Lb-in (N-m)
50A-90A	M6	44.2 (5.0)



Caution: High speed fuses are used only for the thyristor protection and can not be used to protect the installation.



Caution: The warranty of thyristor is null if no proper fuses are used. See tab.



Warning: When powered, the thyristor unit is subject to dangerous voltages; disconnect from the power supply before opening the fuse box and touching electrical equipments.



CD Automation S.r.l.

Via Picasso, 34/36 - 20025 Legnano (MI)- Italy

Tel. +39 0331 577479 - Fax +39 0331 579479

E-mail: info@cdautomation.com - Web: www.cdautomation.com