



Instruction Manual

Micro-controller X Model : PXR3

INP-TN1PXR3f-E

Fuji Electric Co., Ltd.

International Sales Div
Sales Group

Gate City Ohsaki, East Tower, 11-2, Osaki 1-chome,
Shinagawa-ku, Tokyo 141-0032, Japan
<http://www.fujielectric.com>
Phone: 81-3-5435-7280, 7281 Fax: 81-3-5435-7425
<http://www.fujielectric.com/products/instruments/>

Thank you for your purchasing "Fuji Digital Temperature Controller". Please check that the product is exactly the one you ordered and use it according to the following instructions. (Please refer to a separate operation manual for details.) Dealers are cordially requested to ensure the delivery of this Instruction Manual to hands of the end-users.

NOTICE

The contents of this document may be changed in the future without prior notice.

We paid the utmost care for the accuracy of the contents. However, we are not liable for direct and indirect damages resulting from incorrect descriptions, omission of information, and use of information in this document.

CONTENTS

Safety Precautions	3	6-4 Alarm function [option]	21
Index	9	6-5 Ramp/soak function [option]	23
1. Installation/mounting	10	6-6 Communication function [option]	24
2. Wiring	11	6-7 Digital input (DI function) [option]	25
3. Usage	12	6-8 Other function	26
4. Display and operation	13	6-9 Retransmission function [option]	27
5. Setting methods of temperature and parameters	14	7. Setting of input type and control algorithm	28
1st block parameter	14	8. Error indications	30
2nd block parameter	15	[Table 1] Input type code	31
3rd block parameter	16	[Table 2] Input range	31
6. Functions	17	[Table 3] Alarm action type code	32
6-1 ON/OFF control	17	[Table 4] Control output action mode code	33
6-2 Auto-tuning	18	PXR Model Code Cofiguration	34
6-3 Self-tuning	19	Specification	35

Check of specifications and accessories

Before using the controller, check if the type and specifications are as ordered.
 (A table of Model code configuration is given in Page 34).

Check that all of the following accessories are included in the package box.

- Temperature controller ----- 1 unit
- Instruction manual ----- 1 copy
- Mounting bracket ----- 1 pc.
- Watertight packing ----- 1 pc.
- I/V unit (250Ω resistor) ----- 1 pc. (4-20mA DC input type only)



The related documents

Contents	Name	No.
Specifications	Catalogue	ECNO:1138
Operation method	MICRO-CONTROLLER X (Model:PXR3) OPERATION MANUAL	ECNO:409
Communication functions	COMMUNICATION FUNCTIONS (MODBUS) INSTRUCTION MANUAL	INP-TN512642-E
	COMMUNICATION FUNCTIONS (Z-ASCII) INSTRUCTION MANUAL	INP-TN512644-E

Safety Precautions

Before using this product, the user is requested to read the following precautions carefully to ensure the safety. Safety precautions must be taken by every user to prevent accidents.

The safety requirements are classified into "warning" and "caution" according to the following interpretations :

 Warning	Suggesting that the user's mishandling can result in personal death or serious injury.
 Caution	Suggesting that the user's mishandling can result in personal injury or damage to the property.

WARNING Over-temperature Protection

“Any control system design should take into account that any part of the system has the potential to fail”.

“For temperature control systems, continued heating should be considered the most dangerous condition, and the machine should be designed to automatically stop heating if unregulated due to the failure of the control unit or for any other reason”.

The following are the most likely causes of unwanted continued heating:

- 1) Controller failure with heating output constantly on
- 2) Disengagement of the temperature sensor from the system
- 3) A short circuit in the thermocouple wiring
- 4) A valve or switch contact point outside the system is locked to keep the heat switched on.

In any application where physical injury or destruction of equipment might occur, we recommend the installation of independent safety equipment, with a separate temperature sensor, to disable the heating circuit in case of overheating.

The controller alarm signal is not designed to function as a protective measure in case of controller failure.

1. Warning

1.1 Installation and wiring

- This controller designed to be installed at the following conditions.

Operating temperature	-10 to +50 [°C]	
Operating humidity	90%RH or less (Non condensation)	
Installation category	II	Conforming to IEC1010-1
Pollution degree	2	

- The controller must be installed such that with the exception of the connection to the mains, creepage and clearance distances shown in the table below are maintained between the temperature probe and any other assemblies which use or generate a voltage shown in the table below.

Failure to maintain these minimum distances would invalidate the EN 61010 safety approval.

Voltage used or generated by any assemblies	Clearance (mm)	Creepage (mm)
Up to 50Vrms or Vdc	0.2	1.2
Up to 100Vrms or Vdc	0.2	1.4
Up to 150Vrms or Vdc	0.5	1.6
Up to 300Vrms or Vdc	1.5	3.0
Above 300Vrms or Vdc	Contact with our sales office.	

- If the voltage shown above exceeds 50Vdc (i.e. hazardous voltage), the basic insulation is required between all terminals of this controller and the ground, and supplementary insulation is required for the alarm output.

Isolation class of this controller is as shown below. Be sure to check that the isolation class of the controller satisfies your requirements before installation.

—— : Basic insulation, - - - - - : Non-insulation, ——— : Functional insulation

Mains (Power source)	Measured value input
Control output1 (relay output)	Internal circuit
Control output2 (relay output)	Control output1 (SSR drive output / Current output)
Alarm output (ALM1)	Control output2 (SSR drive output / Current output)
Alarm output (ALM2)	Retransmission
	Digital input (with Retransmission)
	Communication (RS485) circuit
	Digital input (DI1, DI2) (without Retransmission)

- If there is a danger of a serious accident resulting from a failure or a defect in this unit, provide the unit with an appropriate external protective circuit to prevent an accident.
- The unit is supplied without a power switch and fuses.
Make wiring so that the fuse is placed between the main power supply switch and this controller.
(Main power supply: 2 pole breaker, fuse rating: 250V, 1A)
- When wiring the power supply terminal, use vinyl insulated 600 volt cable or equivalent.
- To avoid the damage and failure of controller, supply the power voltage fitting to the rating.
- To avoid an electric shock and controller failure, do not turn ON the power before all wiring is completed.
- Be sure to check that the distance is kept to avoid electric shock or firing before turning the power ON.
- Keep away from terminals while the circuit is energized in order to avoid an electric shock and a malfunction.
- Never attempt to disassemble, fabricate, modify, or repair this unit because tampering with the unit may result in a malfunction, electric shock, or a fire.
- Output relay is the part has a limited life.
When output relay contact comes to the end of its life, it might remain on-state, or off-state. For safety, use a protective circuit outside.

1.2 Maintenance precautions

- Be sure to turn off the power before this controller is installed or removed in order to avoid an electric shock, malfunction, and fault.
- Regular maintenance is recommended a longer service life of this controller.
Some parts of this controller have a limited life span, or they will be deteriorated with the lapse of time.
- One-year warranty is guaranteed for this unit including accessories, provided that the controller is properly used.

2. Warning

2.1 Cautions on installation

Avoid the following places for installation.

- A place where the ambient temperature may reach beyond the range of from 0 to 5°C while in operation.
- A place where the ambient humidity may reach beyond the range of from 45 to 85% RH while in operation.
- A place where a change in the ambient temperature is so rapid as to cause condensation.
- A place where corrosive gases (sulfide gas and ammonia gas, in particular) or combustible gases are emitted.
- A place where the unit is subject directly to vibration or shock.
(vibration or shock may cause wrong action of the output relay.)
- A place exposed to water oil, chemicals, steam and vapor.
(if immersed with water, take the inspection by sales office to avoid an electrical leakage and firing)
- A place where the unit is exposed to dust, salty air, or air containing iron particles.
- A place where the unit is subject to interference with static electricity, magnetism, and noise.
- A place where the unit is exposed to direct sunshine.
- A place where the heat may be accumulated due to the radiation of heat.

2.2 Caution on installation on panel

- Insert the mounting bracket (accessory) from the rear side until the main unit is securely fit into the panel. If there should be a play, tighten two screws lightly until the play is eliminated. (Do not tighten the screws excessively because the mounting bracket can be removed from the stopper by the force.)
- The front side of this controller conforms to NEMA 4X (equivalent with IP66).
To ensure the waterproofness between the instrument and the panel, use packings that are provided as accessories in the following manner: (The improper fitting of packings will ruin the waterproofness.)
 - ① As shown in Figure 1, fit a packing to the case of the unit and then insert it in the panel.
 - ② Tighten screws on the fixing frame or fixtures so that no gaps are given between the front of controller and packing and between panels. Check that there are no deviation and deformation of packing as shown in Fig.3.
- If panel strength is weak, it may cause a gap between the packing and the panel, thus impairing water resistance.

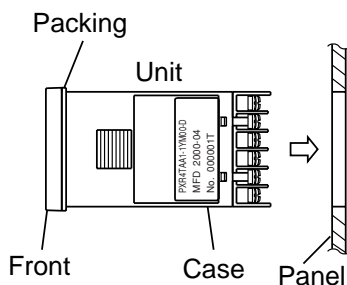

Figure 1

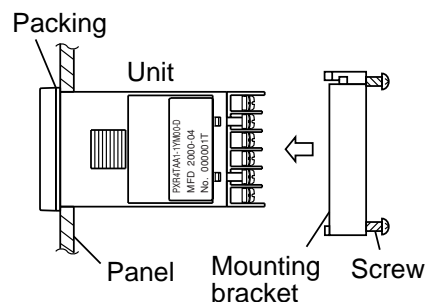

Figure 2

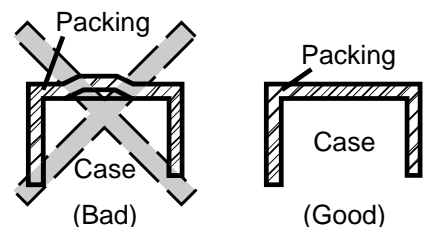
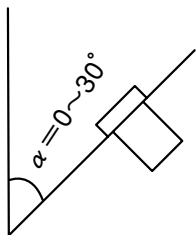

Figure 3

Standard : Vertical mounting, flush on the panel. (The controller is horizontal.)

When mounting the controller on tilted surface, the maximum tilt angle is 30° (degree) from vertical.



(Caution)

- Don't block the openings around the controller, or radiation effect will be reduced.
- Don't block the ventilation openings at the top of the terminal block.

2.3 Precautions in wiring connection

- For the thermocouple sensor type, use thermocouple compensation wires for wiring. For the RTD type, use a wiring material with a small lead wire resistance and no resistance differentials among three wires.
- Keep input lines away from power line and load line to avoid the influence from noise induced.
- For the input and output signal lines, be sure to use shielded wires and keep them away from each other.
- If a noise level is excessive in the power supply, the additional installation of an insulating transformer and the use of a noise filter are recommended.

(Example: ZMB22R5-11 Noise Filter manufactured by TDK)

Make sure that the noise filter is installed to a place such as a panel that is properly grounded. The wiring between the noise filter output terminal and the instrument power supply terminal should be made as short as possible. None of fuses or switches should be installed to the wiring on the noise filter output side because the filter effect will be degraded by such an installation.

- A better anti-noise effect can be expected by using stranded power supply cable for the instrument. (The shorter the stranding pitch is, the better the anti-noise effect can be expected.)
- For the unit with an alarm against a failure (burn-out) in the heater, use the same power line for connection of the power supplies for the heater and the controller.
- A setup time is required for the contact output when the power is turned on. If the contact output is used as a signal for an external interlock circuit, use a delay relay at the same time.
- Use the auxiliary relay since the life is shortened if full capacity load is connected to the output relay. SSR/SSC drive output type is preferred if the output operations occur frequently.

[Proportional interval] relay output: 30 seconds or more, SSR/SSC: one second or more

- If inductive load such as magnetic switches connected as a relay output load, it is recommended to use Z-Trap manufactured by Fuji Electric to protect a contact from switching surge and keep a longer life.

Model : ENC241D-05A (power supply voltage: 100 V)

ENC471D-05A (power supply voltage: 200 V)

Where to install : Connect it between contacts of the relay control output.

Example)

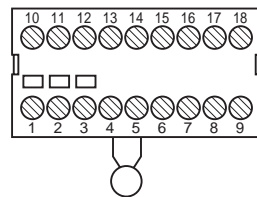

Z-Trap connection

- The SSR/SSC-driven output, output of 4 to 20 mA DC, and retansmission are not electrically insulated from internal circuits. Use a non-grounded sensor for resistance bulb or thermocouple.

2.4 Requirement for key operation/operation in abnormalities

- Prior to the operation, be sure to check alarm functions, since a failure in the proper setting will result in a failure in the proper output of an alarm in case of an abnormality.
- A display of UUUU or LLLL will appear in case of a break in the input. Be sure to turn off the power when a sensor is replaced.

2.5 Others

- Do not use organic solvents such as alcohol and benzine to wipe this controller. Use a neutral detergent for wiping the controller.

Index

<Reference items>	<Description>
Confirming type specification	<ul style="list-style-type: none"> • Confirming that the delivered controller is equal to the ordered one.
↓	
1 Installation/mounting	<ul style="list-style-type: none"> • Outline dimensions • Panel cutout dimensions • Mounting method on the panel
↓	
2 Wiring	<ul style="list-style-type: none"> • Terminal connection diagram
↓	
Power on	
↓ *Note	
3 Usages	<ul style="list-style-type: none"> • Set value change method • Basic operation method • List of parameters • List of input/output/alarm codes
4 Display and operation	
5 Setting method of temperature and parameters	
6 Functions	
↓	
7 Setting of input type and control algorithm.	<ul style="list-style-type: none"> • Setting of input type and ranges • Selecting of control method
↓	
Operation	
↓	
8 Error indications	

(Note) *To start the operation, wait for about 30 minutes after the power-on for warm up.

1

Installation/mounting

Outline and Panel Cutout Dimensions (Standard type/Waterproof type)

Outline dimensions (Unit : mm)

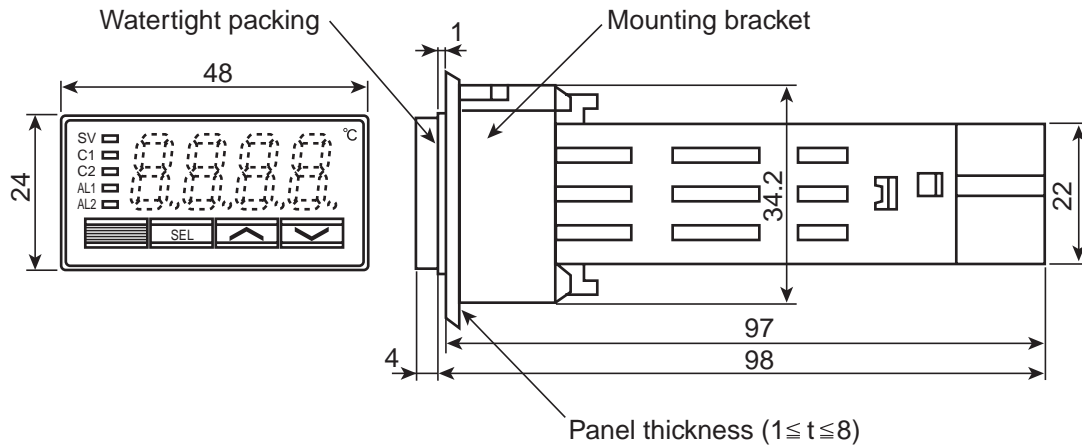

Panel cutout dimensions (Unit : mm)

For separate mounting

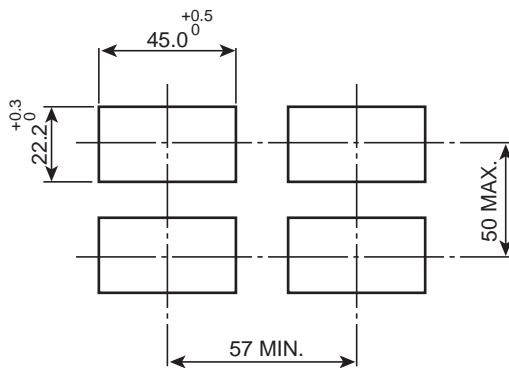

For mounting close together (n controllers)

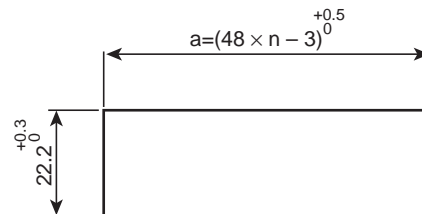

Number of units	2	3	4	5	6
a	93	141	189	237	285

- Note:
- Watertight feature is unavailable if mounted close together.
 - Maximum ambient temperature is 45°C if mounted close together.

2

Wiring

Terminal Connection Diagram (100 to 240 VAC) or (24 VDC/24 VAC)

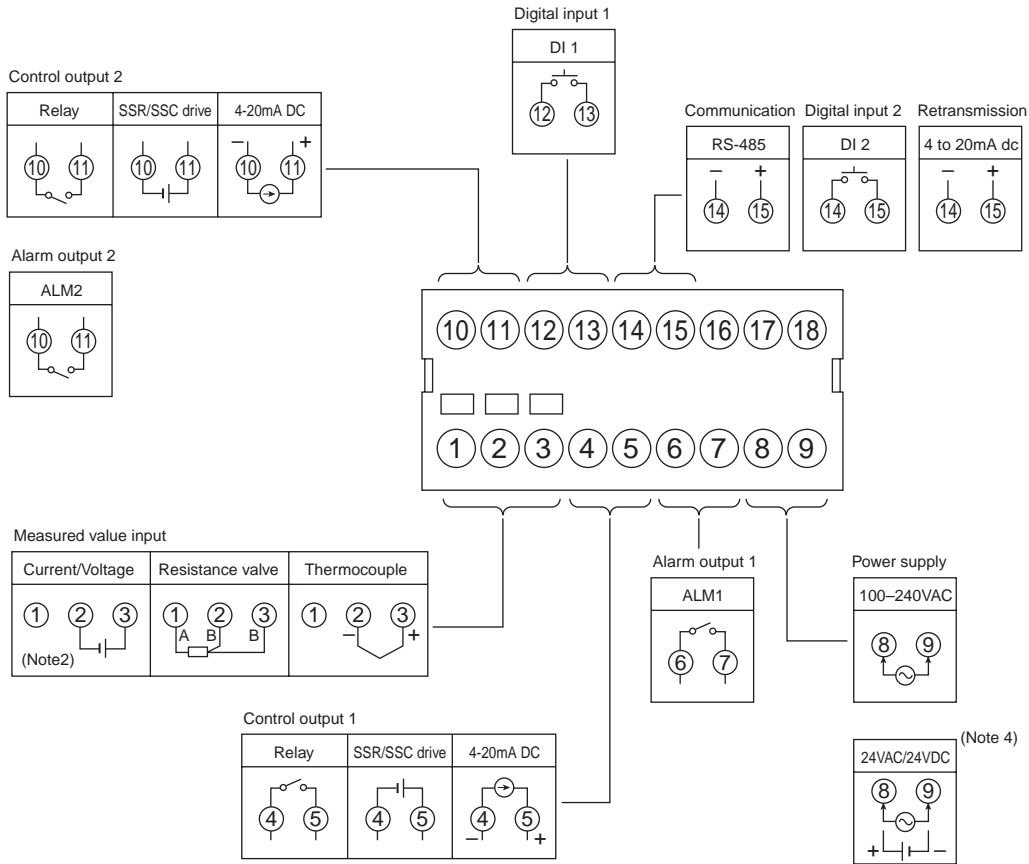

Note1) Check the power supply voltage before installation.

Note2) Connect the I/V unit (250Ω resistor) (accessory) between the terminal ② and ③ in case of current input.

Note3) Tighten the terminal screw securely with fastening torque of 0.4N·m.

Note4) When the 10th digit of the code symbol is "C", "A", or "B", connect the power according to the connection diagram of 24VAC/24VDC power supply. Input of power of 30VAC/30VDC or more will damage the instrument.

Designation of Wiring Material

- Wire

Gauge: AWG28 (0.1mm²) to AWG16 (1.25mm²)
Strip-off length: 5 to 6 mm

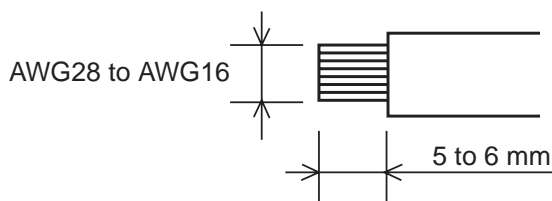

- Rod terminal

Dimension of exposed conductor section:
2 x 1.5 mm or smaller
Length of exposed conductor section:
5 to 6 mm

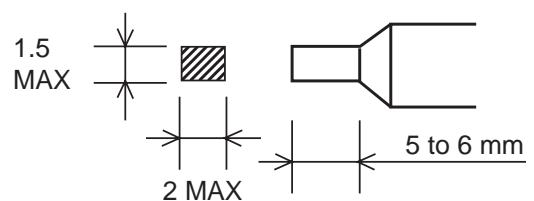

Caution

To prevent disconnection or short circuit, never use the wire other than the one stated above, and make sure to insert it toward the recess of the terminal block.
Fastening torque: 0.4N·m

3 Usage (Read before using)

Name of Functional Parts and Functions

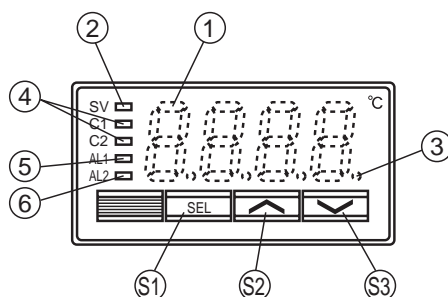

Model : PXR3

Setting keys

	Name	Function
①	Select key	The key shifting to the 1st, the 2nd or the 3rd block parameter, switching the display between parameter and the data at the 1st, the 2nd and the 3rd block.
②	Up key	<ul style="list-style-type: none"> The numerical value is increased by pressing the key once. The numerical value keeps on increasing by pressing the key continuously. For searching parameters within the 1st, the 2nd and the 3rd block.
③	Down key	<ul style="list-style-type: none"> The numerical value is decreased by pressing the key once. The numerical value keeps on decreasing by pressing the key continuously. For searching parameters within the 1st, the 2nd and the 3rd block.

Display/Indication

	Name	Function
①	Process value (PV)/Set value (SV) /parameter name or parameter setting display	<ol style="list-style-type: none"> Displays a process value or set value at operation mode. Displays the parameter name or settings at parameter setting mode. Displays the various error indications (refer to the "8. Error indications"). Flickers at Standby mode when SV is displayed. Displays the set value (SV) and "SV-x" (x:1 to 4) alternately when the SV-switching function is used and SV is displayed.
②	Set value (SV) indication lamp	<ol style="list-style-type: none"> The lamp is lit while a set value (SV) is displayed. Flickers while the process value (PV) is displayed in Standby mode.
③	Auto-tuning/self-tuning indicator	The lamp flickers while the PID auto-tuning or the self-tuning is being performed.
④	Control output indication lamp	<p>C1 : The lamp is lit while the control output 1 is ON.</p> <p>C2 : The lamp is lit while the control output 2 is ON. (Note 1)</p>
⑤	Alarm output 1 (ALM1) indication lamp (Note 1)	The lamp is lit when the alarm output 1 is activated. It flickers during ON-delay operation.
⑥	Alarm output 2 (ALM2) indication lamp (Note 1)	The lamp is lit when the alarm output 2 is activated. It flickers during ON-delay operation.

Note 1) Control output 2 and alarm function are optional.

4

Display and operation

Standby mode

To perform standby operation, set "STby" as ON in the 1st block parameter.

Showing the process value (PV)

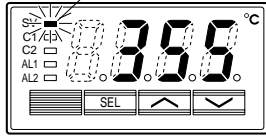

Press the **SEL** key once

Showing the set value (SV)

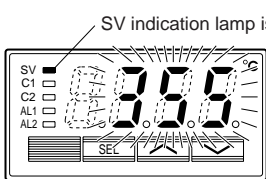

The set value (SV) flickers

Standby mode:
 (Output) Control outputs (1 and 2) and alarm outputs (all) are not provided. However, depending on setting of "P-n1", control action, control outputs are provided at the abnormal input.
 No alarm output is provided at standby mode, even in (Fault-condition).

Caution Be careful since the equipment does not provide output of the alarm of the main unit abnormality during the standby operation.

(Control) Control is not performed.

(Display) While PV being displayed ; SV indication lamp flickers.

While SV being displayed ; SV display value flickers.

Caution The SV display does not flicker while the 1st, 2nd and 3rd block parameters are displayed.

(Setting) SV and parameter settings are able to perform.

Switching by 1st block STby settings

Operation mode

Showing the process value (PV)

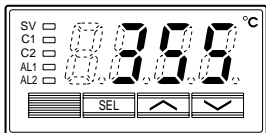

Press the **SEL** key once

Showing the set value (SV)

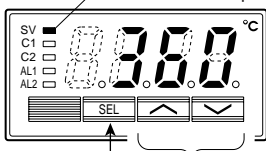

The set value (SV) can be changed.

1 Change of set value (SV)

2 Shift to the 1st, 2nd and 3rd block parameter

To shift to the other blocks, press the **SEL** key.

Caution Depending on the pressing time of **SEL** key, you can select the block to shift.

SEL pressing time	Shifting block
About 1 sec pressing	1st block
About 3 sec pressing	2nd block
About 5 sec pressing	3rd block

After the data setting, the data are registered automatically in 3 seconds.

Switching by the **SEL** key

Parameter setting mode

Press the **SEL** for 2 sec. 1 Parameter selection 2 Parameter settings

3 Shift to operating condition

Operation mode (SV display)

Parameter setting procedure

1 Select a parameter you want to set by pressing the **▲** or **▼** key.

2-1 Press the **SEL** key to display the parameter set value.

2-2 Pressing the **▲** or **▼** key, change the parameter set value.

2-3 After the parameter has been changed, press the **SEL** key for registration.

3 To shift to Operation/Standby mode, press the **SEL** key for 2 sec.

4 If unoperated state continues for 30 seconds, it returns to Operation/Standby mode.

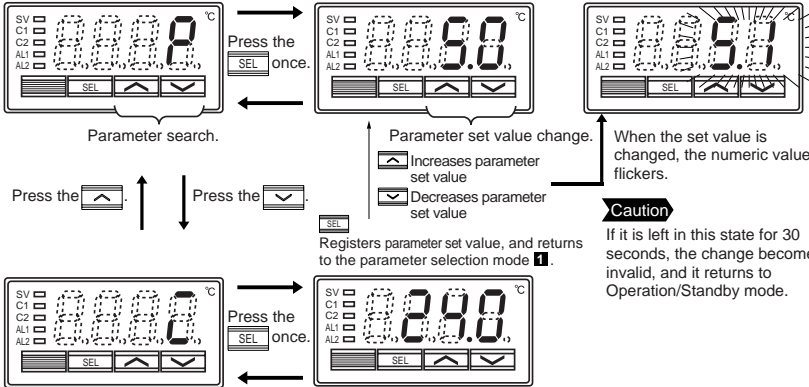

By repeating the same procedure, the parameters can be displayed according to the parameter list shown in "5, Setting methods of

Caution After the parameter has been changed, if unoperated state continues for 30 seconds without pressing the **SEL** key, setting change becomes invalid.

5

Setting methods of temperature and parameters

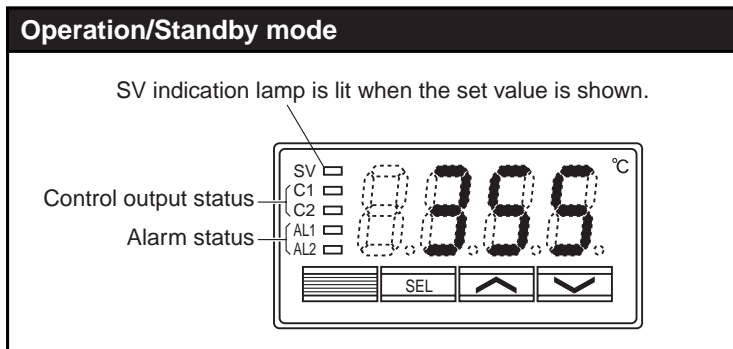

Some parameters may not be displayed on the screen, depending upon the types.

Press for about 1 sec.

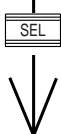

Press for about 2 sec. (Returns to SV indication)



1st block parameter

Parameter display symbol	Parameter	Description of contents	Default setting	Remarks																																								
STBY	STBY	Standby settings	Switches RUN or Standby of the control. ON: Control standby (output: OFF, alarm: OFF) OFF: Control RUN	OFF																																								
ProG	ProG	Ramp/soak control	OFF: stop, rUn: Start, HLd: status hold	OFF																																								
LACH	LACH	Alarm latch cancel	Releases alarm latch. 1: Alarm latch release	0																																								
AT	AT	Auto-tuning	0: Stop, 1: Standard AT start, 2: Low PV type AT start	0																																								
TM-1	TM-1	Timer 1 display	Time display indicating the remaining time in the timer mode.	10																																								
TM-2	TM-2			10																																								
AL1	AL1	Alarm 1 set value	(appears only with alarm action type 1 to 10). Setting range: Note 1	10	Table 3 (Note 1)																																							
A1-L	A1-L	Alarm 1 low limit set value	(appears only with alarm action type 16 to 31). Setting range: Note 1	10	Table 3 (Note 1)																																							
A1-H	A1-H	Alarm 1 high limit set value		10	Table 3 (Note 1)																																							
AL2	AL2	Alarm 2 set value	(appears only with alarm action type 1 to 10). Setting range: Note 1	10	Table 3 (Note 1)																																							
A2-L	A2-L	Alarm 2 low limit set value	(appears only with alarm action type 16 to 31). Setting range: Note 1	10	Table 3 (Note 1)																																							
A2-H	A2-H	Alarm 2 high limit set value		10	Table 3 (Note 1)																																							
LoC	LoC	Key lock	Setting of key lock status.	0																																								
		<table border="1"> <thead> <tr> <th rowspan="2"></th> <th colspan="2">All parameters</th> <th colspan="2">SV</th> </tr> <tr> <th>Front key</th> <th>Comm-unication</th> <th>Front key</th> <th>Comm-unication</th> </tr> </thead> <tbody> <tr> <td>0</td> <td>○</td> <td>○</td> <td>○</td> <td>○</td> </tr> <tr> <td>1</td> <td>×</td> <td>○</td> <td>×</td> <td>○</td> </tr> <tr> <td>2</td> <td>×</td> <td>○</td> <td>○</td> <td>○</td> </tr> <tr> <td>3</td> <td>○</td> <td>×</td> <td>○</td> <td>×</td> </tr> <tr> <td>4</td> <td>×</td> <td>×</td> <td>×</td> <td>×</td> </tr> <tr> <td>5</td> <td>×</td> <td>×</td> <td>○</td> <td>×</td> </tr> </tbody> </table>			All parameters		SV		Front key	Comm-unication	Front key	Comm-unication	0	○	○	○	○	1	×	○	×	○	2	×	○	○	○	3	○	×	○	×	4	×	×	×	×	5	×	×	○	×		
	All parameters		SV																																									
	Front key	Comm-unication	Front key	Comm-unication																																								
0	○	○	○	○																																								
1	×	○	×	○																																								
2	×	○	○	○																																								
3	○	×	○	×																																								
4	×	×	×	×																																								
5	×	×	○	×																																								
				○: Setting enable, ×: Setting disable																																								

Note 1) Setting range : 0 to 100%FS (in case of absolute value alarm)
-100 to 100%FS (in case of deviation alarm)

Note 2) Never set "TC" / "TC2" = 0

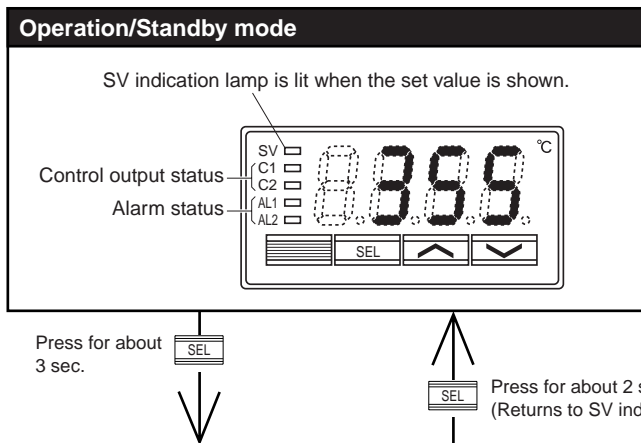

Some parameters may not be displayed on the screen, depending upon the types.

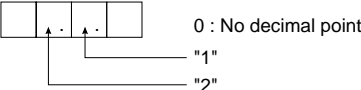
2nd block parameter					
Parameter display symbol	Parameter	Parameter	Description of contents	Default setting	Remarks
P	P	Proportional band	Setting range: 0.0 to 999.9% ON/OFF control when "P" = 0	5.0	
\bar{I}	I	Integral time (reset)	Setting range: 0 to 3200 sec. No integral action when "I" = 0	240	
d	D	Derivative action time	Setting range: 0.0 to 999.9 sec. No derivative action when "d" = 0	60.0	
HYS	HYS	Hysteresis for ON/OFF control	Setting range: 0 to 50% FS	1	
$\bar{C}ool$	Cool	Proportional band coefficient on cooling side	Sets the proportional band coefficient on the cooling side. (Setting range : 0.0 to 100.0) ON/OFF control when "Cool" = 0	1.0	
db	db	Deadband/overlap	Shifts the output value on the cooling side. (Setting range: -50.0 to 50.0%)	0.0	
$\bar{C}TRL$	CTRL	Control algorithm	Type of control algorithm. (Setting range: PID, FUZZY, SELF)	PID	
fC	TC	Cycle time (control output 1)	Sets cycle time of control output 1. (Setting range: 1 to 150 sec)	30/2	Note 2
$fC2$	TC2	Cycle time (control output 2)	Sets cycle time of control output 2. (Setting range: 1 to 150 sec)	30/2	Note 2
$P-n2$	P-n2	Input type code	Type of input	As ordered	Table 1 (Page 4)
$P-SL$	P-SL	Lower limit of input range	Lower limit of input range (Setting range: -1999 to 9999)	As ordered	Table 2 (Page 4)
$P-SU$	P-SU	Upper limit of input range	Upper limit of input range (Setting range: -1999 to 9999)	As ordered	Table 2 (Page 4)
$P-dP$	P-dP	Setting of decimal point position	Select a decimal point position of display. (Setting range: 0 to 2) 	As ordered	Table 2 (Page 4)
$PVOF$	PVOF	PV offset	Shift the display of process value (PV). (Setting range: -10 to 10%FS)	0	
$P-dF$	P-dF	Time constant of input filter	Time constant (Setting range: 0.0 to 900.0 sec.)	5.0	
$ALM1$	ALM1	Type of alarm 1	Setting types of alarm action (Setting range: 0 to 34)	0/5	Table 3 (Page 4)
$ALM2$	ALM2	Type of alarm 2		0/9	Table 3 (Page 4)
$STAT$	STAT	Ramp/soak status	Displays the current Ramp/Soak status. No setting can be made.	-	
Pfn	PTn	Ramp/soak execute type	Selects the ramp/soak execute type. 1: Executes 1st to 4th segment. 2: Executes 5th to 8th segment. 3: Executes 1st to 8th segment.	1	
$SV-1$ ⋮ $SV-8$	SV-1 to SV-8	Ramp target SV-1 to SV-8	Sets the target SV for each ramp segment. (Setting range: 0 to 100%FS)	0%FS	
$TM1r$ ⋮ $TM8r$	TM1r to TM8r	1st ramp segment time to 8th ramp segment time	Sets the time for each ramp segment. (Setting range: 0 to 99 hours and 59 minutes)	0.00	
$TM1S$ ⋮ $TM8S$	TM1S to TM8S	1st soak segment time to 8th soak segment time	Sets the time for each soak segment. (Setting range: 0 to 99 hours and 59 minutes)	0.00	

Operation/Standby mode

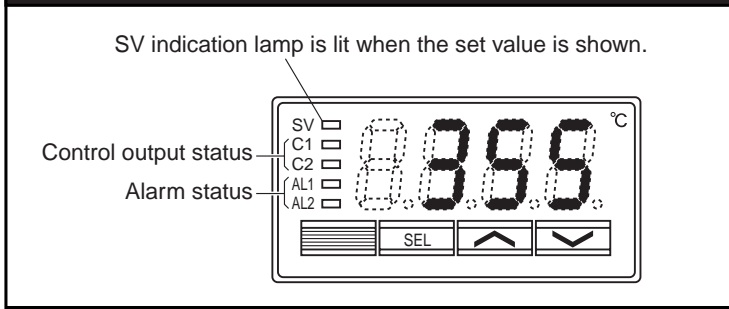

Some parameters may not be displayed on the screen, depending upon the types.

Press for about 5 sec.

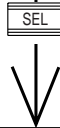

Press for about 2 sec.
(Returns to SV indication)

3rd block parameter

Parameter display symbol	Parameter	Description of contents	Default setting	Remarks
<i>P-n1</i>	P-n1	Control action	0	Table 4 (Page 4)
<i>SV-L</i>	SV-L	Lower limit of SV	0%FS	
<i>SV-H</i>	SV-H	Upper limit of SV	100%FS	
<i>dLY1</i>	dLY1	ON delay time of alarm 1	0	
<i>dLY2</i>	dLY2	ON delay time of alarm 2	0	
<i>A1hY</i>	A1hY	Hysteresis for alarm 1	1	
<i>A2hY</i>	A2hY	Hysteresis for alarm 2	1	
<i>A1oP</i>	A1oP	Additional function of alarm 1	000	Note 3
<i>A2oP</i>	A2oP	Additional function of alarm 2	000	Note 3
<i>dl-1</i>	dl-1	DI1 operation setting	0(OFF)	6-7 (Page 3)
<i>dl-2</i>	dl-2	DI2 operation setting	0(OFF)	6-7 (Page 3)
<i>STno</i>	STno	Station No.	1	
<i>CoM</i>	CoM	Parity setting	0	6-6 (Page 3)
<i>PYP</i>	PYP	Code for PYP input type	34	
<i>Ao-T</i>	Ao-T	Retransmission output type	0: PV	
<i>Ao-L</i>	Ao-L	Retransmission base scale	0%	
<i>Ao-H</i>	Ao-H	Retransmission span scale	100%	
<i>dSP1</i> ⋮ <i>dSP13</i>	dSP1 to dSP13	Parameter mask		

Note 3) De-energized: Contact opens when the alarm "ON".

6 Functions

6-1 ON/OFF control

- At ON/OFF control mode, output signal is as shown below.
Set parameter "P" = 0 for selecting the ON/OFF control mode.
Set the hysteresis to avoid chattering.
(Default setting: Hys = 1)

- Parameter setting and operation example

Example 1 : Reverse operation

Parameter	Setting value
P	0.0
P-n1	0 (or 1)
HYS	Any value

Relationship of PV and SV	Output
PV > SV	OFF
PV < SV	ON

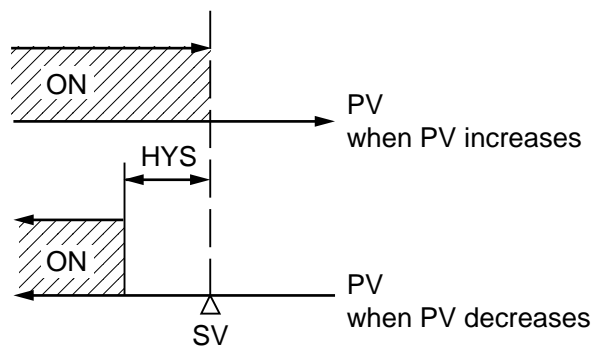

Example 2 : Direct operation

Parameter	Setting value
P	0.0
P-n1	2 (or 3)
HYS	Any value

Relationship of PV and SV	Output
PV > SV	ON
PV < SV	OFF

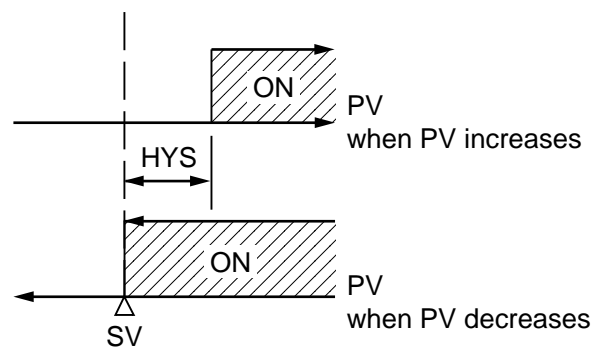

6-2 Auto-tuning (AT)

Autotuning is the automatic calculation and entering of the control parameters (P,I and D) into memory. Prior to the auto-tuning, complete the setting of input range (P-SL,P-SU, P-dP), a set value (SV), alarm setting (AL1, AL2), and cycle time (TC).

How to start the auto-tuning

Set the parameter AT as either "1" or "2" by using \triangle or ∇ key, and press the SEL key to start the auto-tuning. Then the point indicator at the lower right starts blinking. At the completion of Auto-tuning, the point indicator stops blinking, then parameter AT is automatically set to 0.

	When auto-tuning is cancelled or not performed.	Standard type (auto-tuning at SV)	Low PV type (auto-tuning at 10%FS below SV.)
Setting code (AT)	0	1	2

① Standard type (AT=1)

② Low PV type (AT=2) : Overshoot decreased at tuning.

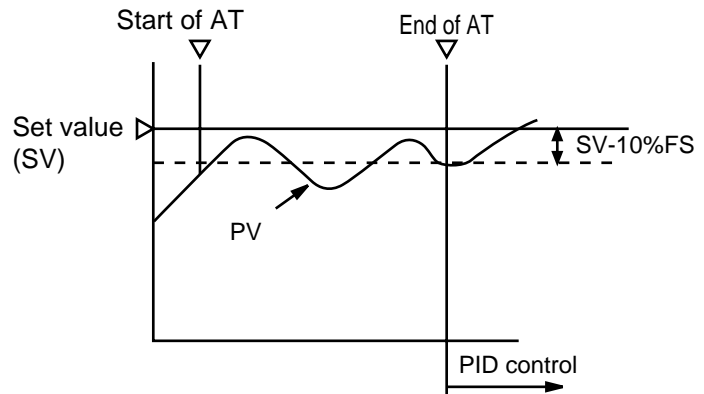
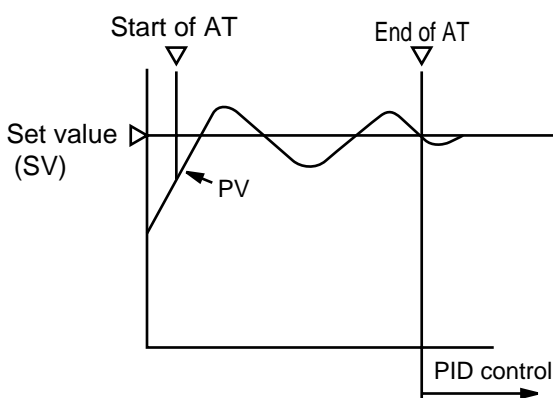

- The P.I.D. parameter calculated by auto-tuning remains even if the power is turned off. If the power is turned off before the auto-tuning is completed, you must restart the auto-tuning.
- The PV may be changed greatly depending on the process, because the control output is ON/OFF action (two position operation) in the auto-tuning. So, do not use the auto-tuning if the process does not allow a significant variation of PV.
In addition, the auto-tuning should not be used in any process such as pressure control and flow control, where a quick-response is required.
- If the auto-tuning isn't completed in four hours, the auto-tuning is suspected to fail. In this case, check the wiring and parameters such as the control action, input type, etc.
- Carry out the auto-tuning again, if there is any change in SV, input range (P-SL, P-SV or P-dP) or process condition. Perform the auto-tuning if fuzzy control is selected as the control algorithm.
- When resetting the AT parameter, set the parameter to "0" once, then reset it.

6-3 Self-tuning

1) At power on, changing a set value or the external disturbance, tuning is made automatically so that the PID parameters are re-optimized.

It is useful where modification of PID parameters is required repeatedly due to frequent change in process condition.

If high controllability is important, select the PID or fuzzy control algorithm and use auto-tuning.

2) Setting for self-tuning

- ① Turn on the power and set the SV.
- ② Select SELF at "CTrL" (control algorithm) parameter.
- ③ Turn off the power once.
- ④ Turn on the power of the whole system. The controller should be turned on at the same time with the other equipments or even later. Otherwise, the self tuning might not be performed successfully.
- ⑤ Self-tuning starts. Then the point indicator at the lower right corner starts blinking until the PID parameters are re-optimized.

Note) Whenever it is necessary to re-try the self-tuning, please set "CTrL" = PID once, and then start the above setting procedure from the beginning.

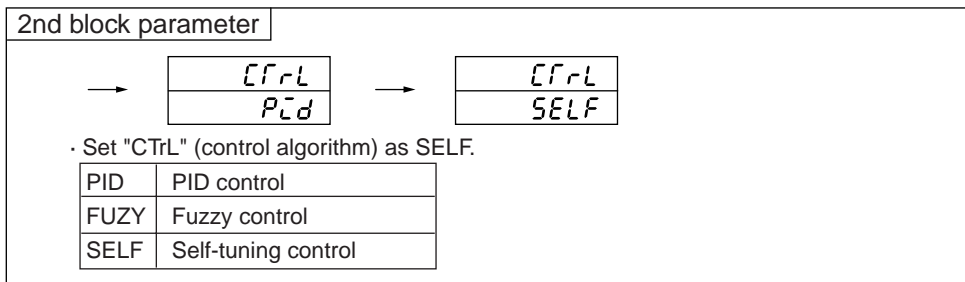

3) Self-tuning indication

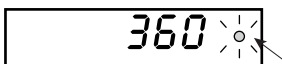

The point indicator at the lower right corner starts blinking until the PID parameters are re-optimized.

4) Self-tuning is executed by any of the following conditions.

- ① During temperature rise at power ON.
- ② During temperature rise at SV changing if necessary.
- ③ When control is out of stable condition and is judged as being out of stable condition continuously.

5) Self-tuning is not executed under the following conditions:

- ① During standby mode
- ② During ON/OFF control
- ③ During auto-tuning
- ④ During ramp/soak operation
- ⑤ During input error
- ⑥ With dual output ("P-n1" ≥ 4)
- ⑦ When P, I, D or Ar is manually set

Under the following conditions, self-tuning is canceled.

- ① When SV is changed.
- ② When Self-tuning can not be completed in about 9 hours after the start.

6) Cautions

- Turn on the power of the whole system. The controller should be turned on at the same time with the other equipments or even later. Otherwise, the self-tuning might not be performed successfully.
- Don't change the SV while the self-tuning is executing.
- Once PID parameters are optimized, the self-tuning is not executed at the next power on unless SV is changed.
- After the execution of self-tuning, if the controllability is not your expected level, please select PID or FUZZY at "CTRL" parameter, and then, start the auto-tuning.

6-4 Alarm function (option)

1) Kinds of alarm

- Absolute value alarm, deviation alarm, combination alarm, and zone alarm are available.
(For details, see Table 4, Alarm action type codes on page 4.)

ON delay function

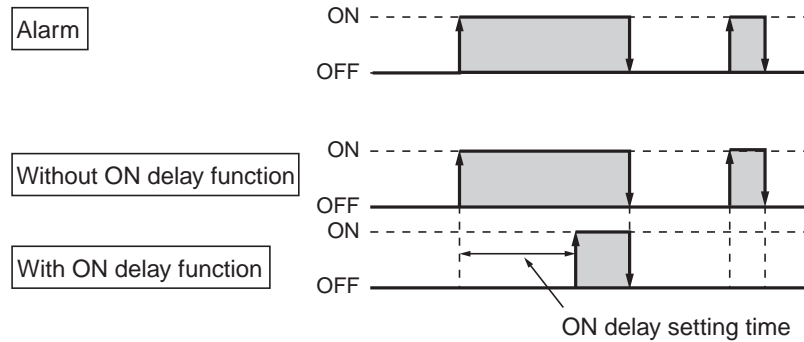

Energizing/de-energizing function

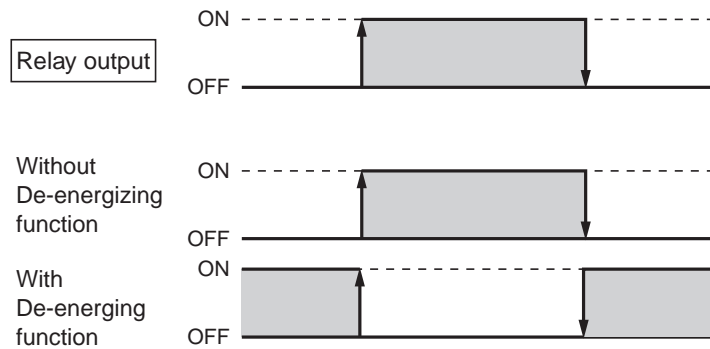

Caution When the power is turned OFF or in Standby mode, even if de-energizing function is turned ON, it cannot be output (it is kept OFF).

2) Alarm function

No.	Function	Description	Parameters to set
①	Hysteresis	Set the hysteresis to avoid chattering.	Alarm 1 : $R1h4$ Alarm 2 : $R2h4$
②	ON delay	The alarm is turned on with delay of a certain seconds as previously set after PV goes in the alarm band.	Alarm 1 : $dLY1$ Alarm 2 : $dLY2$
③	Alarm latch	Keeps the alarm ON status once an alarm is turend ON. To cancel the alarm latch, please take one of the following procedure.	
		i) Turn ON the controller again.	
		ii) Turn the alarm latch settings to OFF once.	Alarm 1 : $R1oP$ Alarm 2 : $R2oP$
		iii) Use alarm latch cancel parameter.	$LRLH$
		iv) Cancel by Digital input.	$dC-1, dC-2$
④	Error status alarm	Alarm is turned on when error indications are displayed.	Alarm 1 : $R1oP$ Alarm 2 : $R2oP$
⑤	De-energizing	Alarm output can be de-energized.	Alarm 1 : $R1oP$ Alarm 2 : $R2oP$

Combination of alarm functions

Please see the table as shown below.

O: Possible combination

X: Impossible combination

	Without HOLD/Timer	With HOLD	With Timer
Alarm latch	O	O	X
De-energizing	O	O	O
ON delay	O	Note 1	X
Alarm in error status	O	O	X

Note 1 If HOLD has not been canceled, the HOLD state is canceled as soon as the measured value goes out of alarm band. If HOLD has been canceled, ON delay is activated as soon as the measured value goes into the alarm band.

▶ Cautions on alarms

No.	Cautions	Items/Classification
1	Note that the ON delay function is effective for alarm in error status.	Alarm in error status
2	Even during "Err" display, alarms in error status work.	Alarm at error indication
3	Even when "LLLL" or "UUUU" is displayed, an alarm function works normally.	
4	Alarm action type codes in No.12 to 15 are also included in No.24 to 27. It is, therefore, recommended to use No.24 to 27. In addition, please note when selecting No.12 to 15, setting in ALM2, dLY2, and A2hy are effective.	Alarm action type code
5	With the HB alarm, ON delay function, de-energizing function and latch function cannot be used.	HB alarm
6	The minimum alarm set value is -199.9.	Alarm set value
7	As the alarm action type changed, the alarm set value may also be changed accordingly.	
8	Note that all of alarm outputs are not provided at the standby condition.	Alarm at standby mode.
9	Error status alarm is not provided at the standby mode.	
10	The HOLD function is effective even if the PV value is in the hysteresis area when the power is turned ON.	

6-5 Ramp/soak function [option]

1. Function

Changes the set value (SV) as the time elapses according to a predetermined program pattern, as shown below.

Either 4 ramp/soak x 2 patterns or 8 ramp/soak x 1 pattern can be programmed. The first ramp starts from the process value (PV) just before the programming is executed.

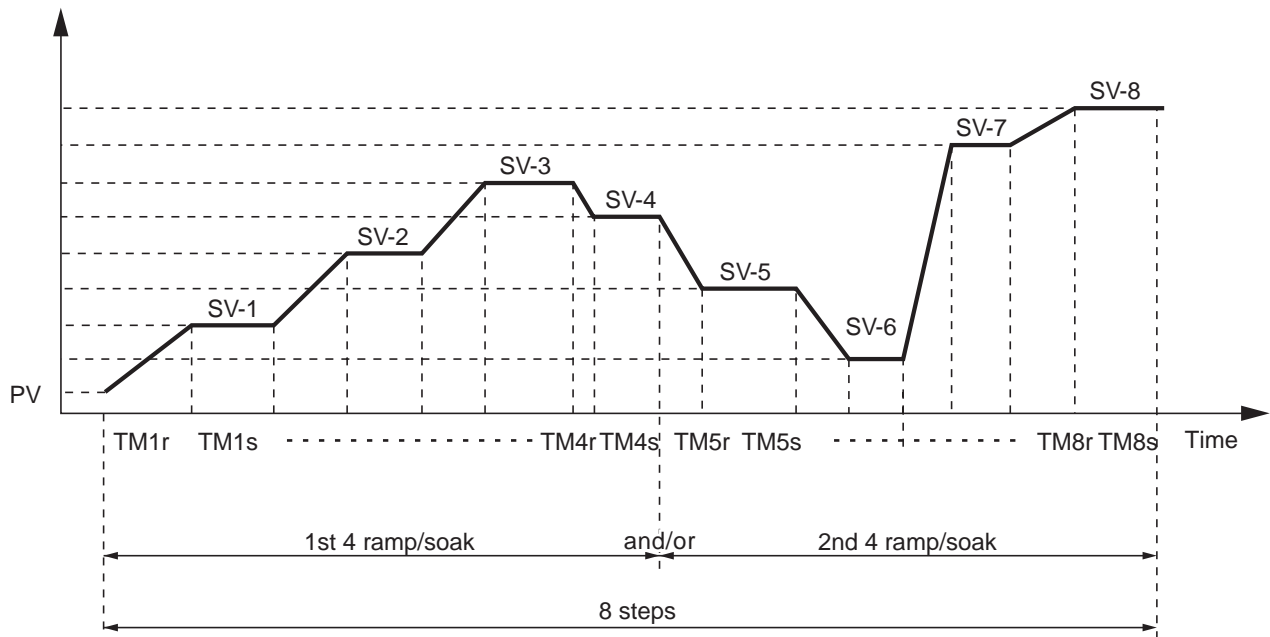

2. Setting

- Select the program pattern (PTn) and set the rUn at “ProG” parameter.
- Ramp/soak pattern can not be changed while ramp/soak program is running.

PTn	Pattern	Ramp/Soak
1	1	4
2	2	4
3	1 + 2	8

Note:

- The ramp/soak program is canceled if the controller becomes to standby mode.
Then, if the controller becomes to operation mode, the program doesn't run again.

6-6 Communication function [option]

1) Function

- Data can be written/read through the RS-485 communication.

2) Before using this function, please set related parameters as shown below.

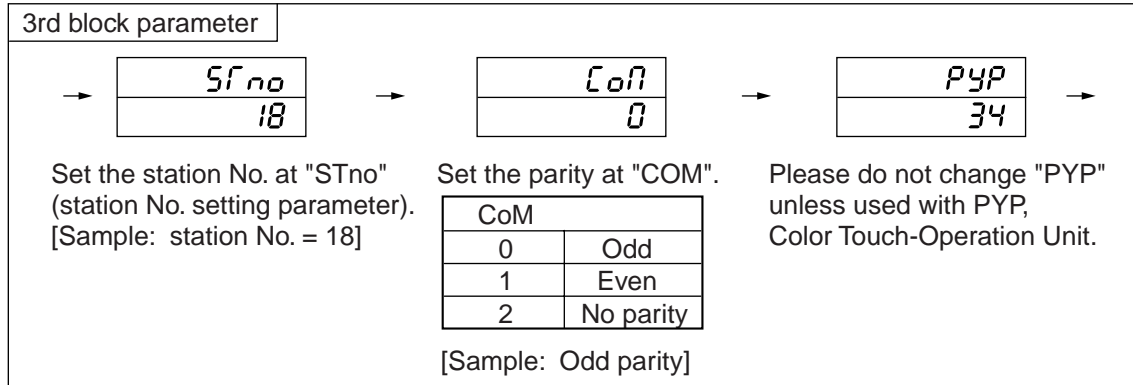

3) Caution

- Station No. can be set in the range of 0 to 255. (No communication is allowed with 0).
- After changing the setting of parity at "COM", please power off and re-start the controller.
- Baud rate is fixed to 9600 bps.
- Communication cannot be carried out with different communication protocol (such as ModbusRTU or Z-ASCII).

6-7 Digital input (DI function) [option]

1) Function

- With Digital input, the following functions are available.
- ① SV switching
- ② Control mode; RUN/STANDBY selection
- ③ Ramp/soak RUN/RESET selection
- ④ Auto-tuning start/stop
- ⑤ Alarm latch cancel
- ⑥ Timer start/reset

2) To use DI function;

- Select the function referring to the Table shown below.

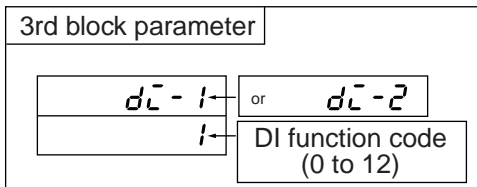

3) Table of DI function

DI function code	Function	Description
1	Set value (SV) switching	Switching between local SV and " $S\bar{v}-1$ " " $S\bar{v}-2$ " " $S\bar{v}-3$ "
2	Control mode, RUN/STANDBY	At standby mode, control is not provided and SV flickers.
3	Auto-tuning (standard) start	Start/Stop can be switched at the time of DI raising up or dropping down.
4	Auto-tuning (low PV) start	
5	All alarm latch cancel	When this function is not used, DI is not effective.
6	Alarm 1 latch cancel	
7	Alarm 2 latch cancel	
9	ALM1 timer	ON/OFF delay timer operation is available. The remaining time of the timer can be checked with timer-1 and -2 display parameters (first block).
10	ALM2 timer	
12	Ramp/soak RUN/RESET	RUN/RESET of ramp/soak can be performed at the time of DI raising up or dropping down.

6-8 Other functions

The parameters "bAL" and "Ar" are masked at default setting.

If necessary to appear these parameters, please refer to the following procedure.

1) Function

- "bAL" and "Ar" are functions to suppress overshoot.

(Usually it is not necessary to change the setting.)

2) If they aren't optimum value, sometime you don't get the good control. Usually it is not necessary to set them.

3) "Ar"(Anti-reset wind-up) is automatically set by "Auto tuning".

1 bAL

MV is calculated by adding the offset (bAL) to MV', the result of PID calculation, from PV and SV.

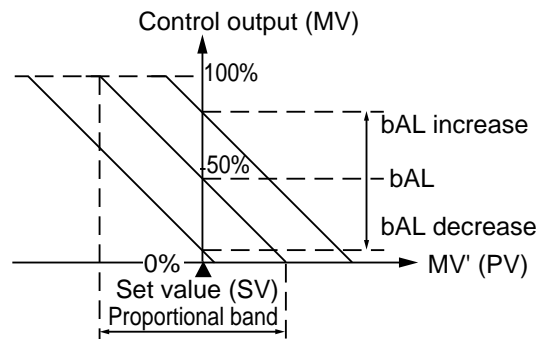
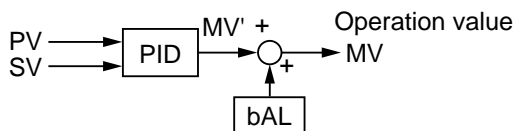

2 Ar

The integral range is $SV \pm Ar$.

Integral action don't work when PV is out of the range.

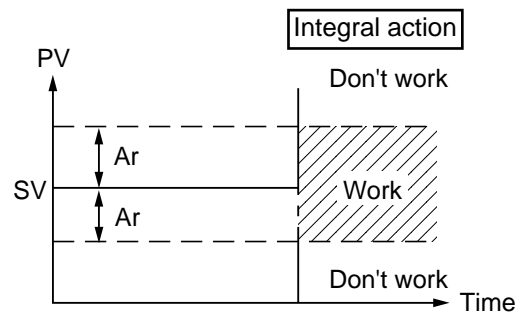

Mask/Unmask bAL and Ar

1 To unmask

- ① Display the "dSP3" in the third block parameter and then subtract 128 from current value.
- ② Display the "dSP4" in the third block parameter and then subtract 1 from current value.

2 To mask

- ① Display the "dSP3" in the third block parameter and then add 128 to current value.
- ② Display the "dSP4" in the third block parameter and then add 1 to current value.

6-9 Retransmission function [option]

1) Function

It is the function that outputs one of signals as shown below with current such as 4 to 20mA dc.

Output type: PV, Setpoint, Output or Error

2) Before using this function, please set related parameters as shown below.

3rd block parameter

$Ao-L$
0

$Ao-L$
250

$Ao-H$
750

Setting output type for Retransmission. Setting lower limit scaling. Setting upper limit scaling.

Ao-T	
0	PV
1	SV
2	MV
3	DV

Example: Input ... K thermocouple, 0 ~ 800°C range
4 ~ 20mA signals are to be output when PV values are at 200 - 600°C

Measured value

AO signal type ... PV value

- 600°C → 75% of input range
- 200°C → 25% of input range

(Setting)

$Ao-L$... "0"

$Ao-H$... 75.0(%)

$Ao-L$... 25.0(%)

3) Note

- Don't set $Ao-L \geq Ao-H$.
- Setting unit for $Ao-L$ and $Ao-H$ is %FS.

7

Setting of input type and control algorithm

1 Setting of the input type

* Skip this procedure if the input type is specified when you order.

① Please check if the input type set at "P-n2" is same as what you use.

Choose the sensor type you use from Table 1 shown below, and set the code at "P-n2".

(Example) For T thermocouple, set "P-n2"=7.

(Note) Please refer to the following table for the modification of the input type.

TC ←————→ RTD (within Group I)*	Can be modified by changing "P-n2".
TC/RTD ←————→ 1 to 5Vdc (Group I)* 4 to 20mAdc (Group II)*	Modification not possible

TC : Thermocouple RTD : Resistance bulb (*Please refer to table 1)



② Is setting of input temperature range suitable for the sensor you use?

Standard range to each sensor is shown in Table 2. Select the temperature range suitable for the equipments you use, set lower/upper limit values to "P-SL" / "P-SU" respectively.

(Example) For temperature range 0 to 800 [°C] : Set "P-SL" and "P-SU" to 0 and 800 respectively.

(Note) If the span of setting ranges is smaller than the one of minimum standard range, the accuracy (% full scale) is influenced.

(Note) No standard range is given in case of 1 to 5VDC (4 to 20mA DC) input. Please set the range within the following limitation.

- Maximum span : 9999
- Lower limit : -1999
- Upper limit : 9999

Note:

Please set "P-n2": Input sensor type and "P-SL/P-SU/P-dP": input range setting prior to any other parameter settings. When "P-n2" and/or "P-SL/P-SU/P-dP" is changed, some other parameters may also be influenced. Please check all parameters before starting control.

2 Setting of the algorithm

* Read if the control doesn't work as you expect.

① Select the type of control output action.

	Control output action	Description	Setting procedure
Heating	Reverse	As PV increases, MV decreases. As PV decreases, MV increases.	Set parameter "P-n1" = 0 or 1. (Refer to Table 2)
Cooling	Direct	As PV increases, MV also increases. As PV decreases, MV also decreases.	Set parameter "P-n1" = 2 or 3. (Refer to Table 2)



② Control algorithm (ON/OFF, PID or fuzzy)

Type of control	Description	Setting procedure
ON/OFF control	Output is either ON (100%) or OFF (0%). (Suitable when frequent output switching is inconvenient.)	Set "P" =0.0. Refer to "6-1 ON/OFF control"
PID control	The output signal changes within the range at 0 to 100% according to PID calculation which determine the proportional of ON to OFF in each TC (cycle time).	Select PID at "CTrL". Execute auto-tuning so that optimum P.I.D can be calculated automatically. (PID parameters can be set spontaneously). *Refer to "6-2 Auto-tuning".
Fuzzy control	Fuzzy operation is added to PID providing control with less overshoot.	Select FUZY at "CTrL". Then execute the auto-tuning so that FUZZY control starts.
PID control with self-tuning.	At power on, changing a set value or the external disturbance, tuning is made automatically so that the PID parameters are re-optimized. It is useful where modification of PID parameters is required repeatably due to frequent change in process condition.	Select SELF at "CTrL". Refer to "6-3 Self-tuning".

8

Error indications

Error indications

This controller has a display function to indicate several types of error code shown below.

If any of the error codes is displayed, please eliminate the cause of error immediately.

After the cause is eliminated, turn off the power once, and then re-start the controller.

Error code	Possible cause	Control output	Group
UUUU	<ul style="list-style-type: none"> ① Thermocouple burnt out. ② RTD (A) leg burnt out. ③ PV value exceeds P-SU by 5% FS. 	<ul style="list-style-type: none"> ① when the burn-out control output is set as the lower limit (standard): OFF or 4 mA or less 	I
LLLL	<ul style="list-style-type: none"> ① The RTD leg (B or C) burnt out. ② The RTD leg (between A and B or A and C) short. ③ PV value is below P-SL by 5%FS. ④ 1 to 5 VDC or 4 to 20mADC wiring open or short. 	<ul style="list-style-type: none"> ② when the burn-out control output is set as the upper limit: ON or 20 mA or larger 	
LLLL	<ul style="list-style-type: none"> ① PV value < -1999. <p>Note) In case of RTD input, "LLLL" is not displayed even if the temperature becomes below -150 °C.</p>	Control is continued until the value reaches -5% FS or less, after which burn-out condition will occur.	II
Err (SV indication flickers)	Incorrect range setting (P-SL/P-SU).	OFF or 4mA or less	
FALF	Fault in the control.	Undefined (Stop using this controller immediately.) Contact with Fuji Electric Co.,Ltd. or the nearest representatives.	

[Table 1] Input type code

Parameter : P-n2

Group	Input type	Code
I	RTD · Pt100 (IEC)	1
	Thermocouple · J	2
	· K	3
	· R	4
	· B	5
	· S	6
	· T	7
	· E	8
	· N	12
	· PL-II	13

Group	Input type	Code
II	1 to 5V DC, 4 to 20mA DC	16

In case of 4 to 20mA DC input,
mount a 250Ω resistor
enclosed in the package box.

· Modification

TC ↔ RTD (within Group I)	Can be modified by changing "P-n2"
TC/RTD ↔ 1 to 5V DC (Group I) 4 to 20 mA DC (Group II)	Modification is not possible

[Table 2] Input range (Standard range)

Parameter : P-SL, P-SU, P-dP

Input signal type		Range (°C)	Range (°F)	Input signal type		Range (°C)	Range (°F)
RTD (IEC)	Pt100 Ω	0 to 150	32 to 302	Thermo- couple	R	0 to 1600	32 to 2912
	Pt100 Ω	0 to 300	32 to 572		B	0 to 1800	32 to 3272
	Pt100 Ω	0 to 500	32 to 932		S	0 to 1600	32 to 2912
	Pt100 Ω	0 to 600	32 to 1112		T	-199 to 200	-328 to 392
	Pt100 Ω	-50 to 100	-58 to 212		T	-150 to 400	-238 to 752
	Pt100 Ω	-100 to 200	-148 to 392		E	0 to 800	32 to 1472
	Pt100 Ω	-150 to 600	-238 to 1112		E	-199 to 800	-328 to 1472
	Pt100 Ω	-150 to 850	-238 to 1562		N	0 to 1300	32 to 2372
Thermo- couple	J	0 to 400	32 to 752	PL-II	0 to 1300	32 to 2372	
	J	0 to 800	32 to 1472	DC voltage	1 to 5VDC	-1999 to 9999 (Scaling is possible) • Maximum span : 9999 • Lower limit : -1999 • Upper limit : 9999	
	K	0 to 400	32 to 752				
	K	0 to 800	32 to 1472				
	K	0 to 1200	32 to 2192				

Note 1) Except for the following, the input accuracy is $\pm 0.5\% \text{ FS} \pm 1 \text{ digit} \pm 1^\circ\text{C}$ (Input accuracy does not be guaranteed for the ranges of measurement other than in the table above.)
 $\left. \begin{array}{l} R \text{ thermocouple } 0 \text{ to } 400^\circ\text{C} \\ B \text{ thermocouple } 0 \text{ to } 500^\circ\text{C} \end{array} \right\}$ in these ranges, this controller may display an incorrect process value due to the characteristic of the sensor.

Note 2) In case a measuring range of -150 to 600°C or -150 to 850°C is used for resistance bulb input, temperatures below -150°C does not be indicated correctly. Therefore, "LLLL" does not appear despite a continuous fall below -150°C .

Note 3) If the resistance bulb or thermocouple is used at a temperature below the lowest value in the measurement range, the input accuracy cannot be guaranteed.

Note 4) Addition of decimal point is impossible if the input range or span is larger than 999.9 at the RTD/thermocouple input.

[Table 3] Alarm action type code

Parameter : P-AH, P-AL

Standard alarm code

	ALM1	ALM2	Alarm type	Action diagram
	0	0	No alarm	
Absolute value alarm	1	1	High alarm	
	2	2	Low alarm	
	3	3	High alarm (with hold)	
	4	4	Low alarm (with hold)	
Deviation alarm	5	5	High alarm	
	6	6	Low alarm	
	7	7	High/Low alarm	
	8	8	High alarm (with hold)	
	9	9	Low alarm (with hold)	
	10	10	High/Low alarm (with hold)	
Zone alarm	11	11	High/Low deviation alarm (ALM1/2 independent action)	
	-	12	High/Low absolute alarm	
	-	13	High/Low deviation alarm	
	-	14	High absolute /Low deviation alarm	
	-	15	High deviation /Low absolute alarm	

Timer code

	ALM1	ALM2	Alarm type	Action diagram
Timer	32	32	ON delay timer	
	33	33	OFF delay timer	
	34	34	ON/OFF delay timer	

Alarm code with dual set value

	ALM1	ALM2	Alarm type	Action diagram	
High /Low limit alarm	16	16	High/Low absolute alarm		
	17	17	High/Low deviation alarm		
	18	18	High absolute /Low deviation alarm		
	19	19	High deviation /Low absolute alarm		
	20	20	High/Low absolute alarm (with hold)		
	21	21	High/Low deviation alarm (with hold)		
	22	22	High absolute /Low deviation alarm (with hold)		
	23	23	High deviation /Low absolute alarm (with hold)		
	Zone alarm	24	24	High/Low absolute alarm	
		25	25	High/Low deviation alarm	
26		26	High absolute /Low deviation alarm		
27		27	High deviation /Low absolute alarm		
28		28	High/Low absolute alarm (with hold)		
29		29	High/Low deviation alarm (with hold)		
30		30	High absolute /Low deviation alarm (with hold)		
31		31	High deviation /Low absolute alarm (with hold)		

Point

What is alarm with hold?

The alarm is not turned ON immediately even when the process value is in the alarm band. It turns ON when it goes out the alarm band and enters again.

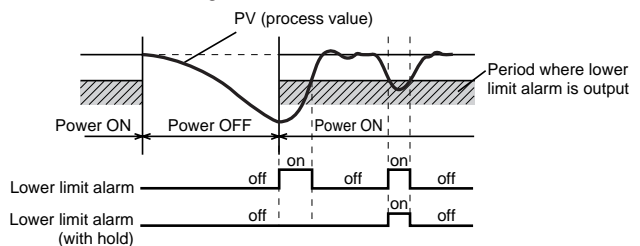

Note) · When alarm action type code is changed, alarm set value may also become different from previous settings.

Please check these parameters, turn off the power once, and then re-start the controller, before starting control.

- When selecting No.12 to 15, setting in ALM2, dLY2, and A2hy are effective, and output to the AL2 relay.

[Table 4] Control output action mode code

Parameter : P-n l

Code	Output	Control output action		Output at Burn-out*		
		Output 1	Output 2	Output 1	Output 2	
0	Single (Control output 1)	Reverse action	---	Lower limit	---	
1				Upper limit		
2		Direct action		Lower limit		
3				Upper limit		
4	Dual [Control output 1 and 2. Heating/Cooling]	Reverse action	Direct action	Lower limit	Lower limit	
5				Upper limit		
6				Lower limit	Upper limit	
7				Upper limit		
8		Direct action		Lower limit	Lower limit	
9				Upper limit		
10				Lower limit	Upper limit	
11						Upper limit
12		Reverse action	Reverse action	Lower limit		Lower limit
13				Upper limit		
14				Lower limit	Upper limit	
15				Upper limit		
16		Direct action		Lower limit	Lower limit	
17				Upper limit		
18				Lower limit	Upper limit	
19				Upper limit		

(*) Outputs when Error Indication Group I.

Please refer to 8 (Error indications).

This is effective even in Standby mode.

Lower limit: OFF or 4mA or less

Upper limit: ON or 20mA or more

[Caution for dual output] (option)

- (1) Parameter "I" and "D" can not be set separately.
- (2) In case "P"=0 (ON/OFF control) for heating side, cooling side becomes ON/OFF control automatically.
- (3) In case "Cool" =0.0, cooling side becomes ON/OFF control. And hysteresis is fixed at 0.5%FS.

PXR Model Code Configuration

Digit	Specification	4	5	6	7	8	9	10	11	12	13	14
4	<Size of front H X W> 24 X 48mm	3										
5	<Input signal> Thermocouple °C Thermocouple °F RTD Pt100Ω 3-wire type °C RTD Pt100Ω 3-wire type °F 1 to 5VDC 4 to 20mA DC		T R N S A B									
6	<Control output 1> Relay contact output SSR / SSC driving output 4 to 20mA DC output			A C E								
7	<Control output 2> None Relay contact output SSR/SSC driving output 4 to 20mA DC output				Y A C E							Note 1
8	<Revision code>				1							
9	<Optional specification 1> None Alarm 1 point 8 ramps / soaks Alarm 1 point + 8 ramps / soaks Alarm 2 points Alarm 2 points + 8 ramps / soaks						0 1 4 5 F G					Note 1
10	<Instruction manual> <Power supply voltage> None 100 to 240VAC Japanese 100 to 240VAC English 100 to 240VAC None 24VAC/24VDC Japanese 24VAC/24VDC English 24VAC/24VDC						N Y V C A B					
11-13	<Optional specification 2> None RS-485 Modbus interface RS-485 Z-ASCII interface Retransmission + Digital input 1 point Retransmission Digital input 2 points RS-485 Modbus interface + Digital input 1 point RS-485 Z-ASCII interface + Digital input 1 point						0 0 0 M 0 0 N 0 0 Q 0 0 R 0 0 T 0 0 V 0 0 W 0 0					Note 2 Note 2
14	<Non-standard specification> Non-standard parameter setting											F

Note 1) In case of 7th digit code "A", "C", or "E", the codes "F" and "G" in 9th digit are not available.

Note 2) In case of 11th digit code "Q", or "R", the codes "A", "C", "E" in 7th digit, "F", "G" in 9th digit and "A", "B", "C" in 10th digit are not available.

Specification

Power voltage:	100 (-15%) to 240 (+10%), 50/60Hz 24V AC 50/60Hz, 24V DC
Power consumption:	6VA or less (100V AC), 8VA or less (240V AC, 24V AC/24V DC)
Relay contact output:	SPST contact, 220V AC/30V DC 3A (resistive load)
SSR/SSC driving output*1: (voltage pulse output)	ON: 15V DC (12 to 16V DC) OFF: 0.5V DC or less Maximum current: 20mA or less Resistive load: 600Ω or more
4-20mA DC output*1:	Allowable load resistor: 100 to 500Ω
Alarm output:	Relay contact (SPST contact) 220V AC / 30V DC 1A (resistive load)
Communication function*2: (RS-485 interface)	Transmission system: Half-duplex bit serial start-stop synchronization Transmission rate: 9600bps Transmission protocol: In conformity to Modbus RTU or Z-ASCII (PXR protocol) Transmission distance: Up to 500m (Total length) Connectable units: Up to 31 units
Digital input:	Number of input: 2 inputs MAX. Input contact capacity: 5V, 2mA DC
Retransmission:	4 to 20mA DC Allowable load resistor: 500Ω or less Accuracy: ±0.3%FS (at 23°C)
Operating ambient temperature:	-10 to 50°C -10 to 45°C (for mounting close together)
Operating ambient humidity:	90%RH or less (no condensation)
Preservation temperature:	-20 to 60°C

*1 : The following table shows the difference of outputs among other micro-controller X series models.

	SSR/SSC driving output		Allowable load resistance for 4 to 20mA DC output
	Voltage	Maximum current	
PXR3	15V DC	20mA	100 to 500Ω
PXR4	24V DC	20mA	600Ω or less
PXV3	5.5V DC	20mA	600Ω or less
PXV/W/Z	24V DC	60mA	600Ω or less

*2 : For the connection with a PC, communication converter is required.

Modbus RTU : A trademark of Modicon Corp.,USA